

4^D

The Wireless World

AND RADIO REVIEW

The Paper for Every Wireless Amateur

Wednesday, May 7th, 1930.

Run your Portable from the Electric Supply

NO BATTERIES
NO ACCUMULATORS

EKCo

Write for Free Booklet and details of Easy Payments to E. K. Cole Ltd., Dept. W., "Ekco" Works, Leigh-on-Sea.

POWER SUPPLY UNITS FOR PORTABLES

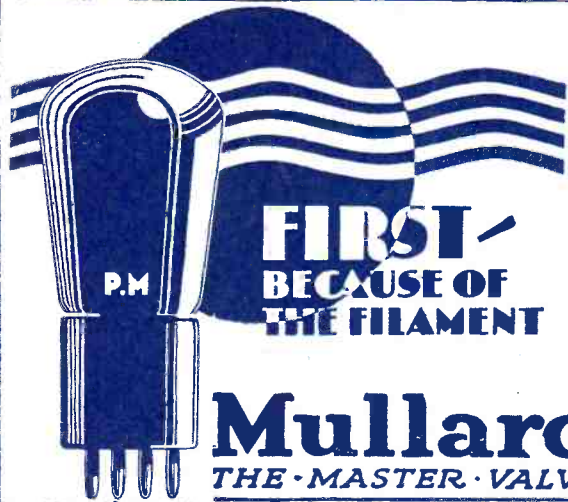

FIRST- BECAUSE OF THE FILAMENT

Mullard
THE MASTER VALVE

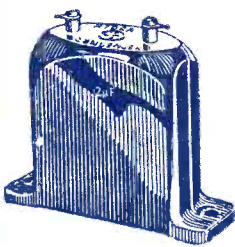

It is 30 years ago since we first said of Hydra condensers—"They never fail." To-day we say so with even more conviction.

HYDRA

LOUIS HOLZMAN 37, NEWMAN ST., LONDON, W.1. Telephone: Museum 2641.

STILL ON TOP!



BLUE SPOT 66K UNIT

25/-

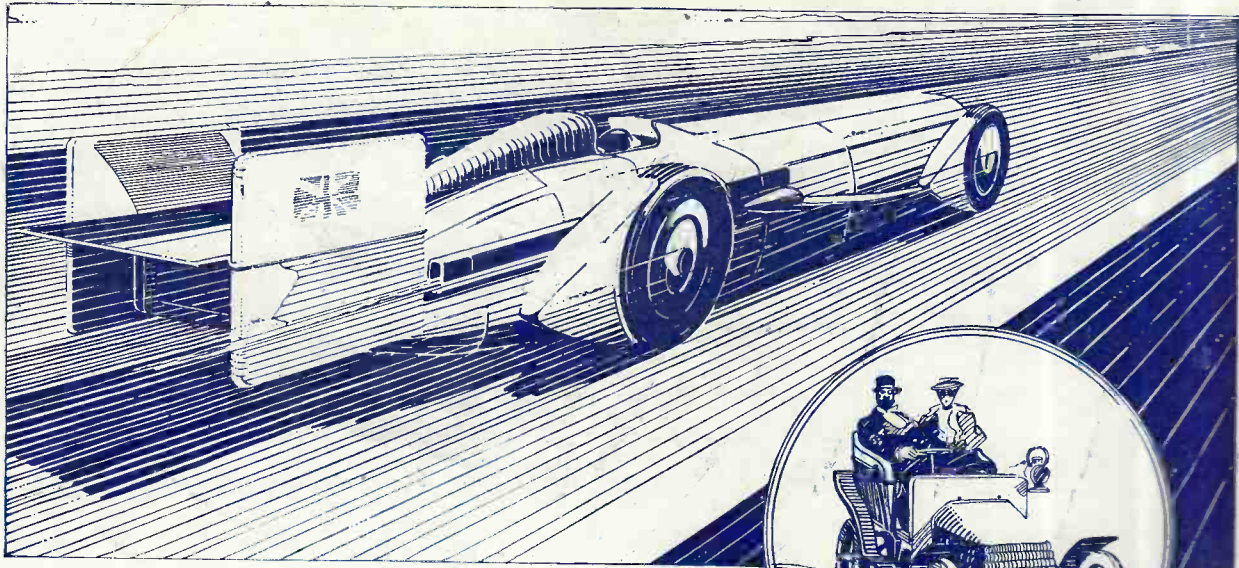

PROGRESS

60%
LONGER LIFE
**What
a life!**

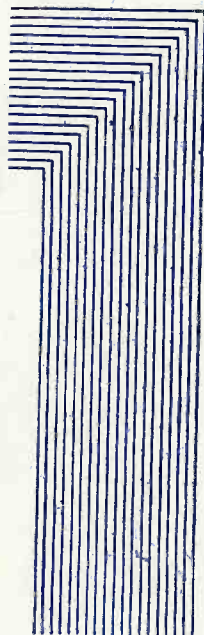

What a tremendous difference there is between the modern racing car and the early motor car of the first few years of the twentieth century. The difference between the Pertrix battery and the sal-ammoniac dry battery is just as great however. The Pertrix has such an amazingly long life—in many cases as much as 80% longer. And the reason is that the Pertrix contains

NO SAL-AMMONIAC

It never corrodes as do ordinary sal-ammoniac batteries, and you are able to obtain clear, powerful reception until every atom of power has been used.

See that you get a **Pertrix** battery.

You can also obtain Pertrix batteries for your flash lamp.
Write for leaflet "B," which will give you full particulars of all types.

		PRICES.					
		DISCHARGE 12 MILLIAMPS.				GRID BIAS.	
		STANDARD.					
		Size in inches.					
Volts.	L.	B.	H.	s.	d.	Volts.	s.
60	5 7/8	6 1/2	3 7/8	8	0	9	1 6
100	8 7/8	6 1/2	3 7/8	13	0	12	2 3
120	10 3/8	6 1/2	3 7/8	15	6	15	2 9

PERTRIX

PATENT
DRY BATTERY

PERTRIX, LTD., Britannia House, 233, Shaftesbury Avenue, London, W.C.2

Mention of "The Wireless World," when writing to advertisers, will ensure prompt attention.



A WONDERFUL

2-Volt SUPER POWER VALVE

built like a 6 volt 'Super'.

OSRAM P. 2

The latest addition to the Famous range of OSRAM Super Power Valves

Tone and quality of a super power valve without loss of range.

Specially suitable for portable sets where the volume and tone of a super power valve is required with a minimum supply of H.T. current.

SUPER POWER

Osram Valves

MADE IN ENGLAND

Sold by all Wireless Dealers.

FOR ECONOMICAL WIRELESS



Note these Characteristics.

- Filament Volts.....2.0 max.
- Filament Current.....**0.2 amps.**
- Anode Volts.....150 max.
- Amp. Factor.....**6.5**
- Impedance.....**2,300 ohms.**
- Mutual Conductance.....2.8

PRICE 15/-

Advt. of The General Electric Co., Ltd., Magnet House, Kingsway, London, W.C.2.

Advertisements for "The Wireless World" are only accepted from firms we believe to be thoroughly reliable.

RADIO DATA CHARTS

A SERIES OF ABACS

providing most of the essential Data required in Receiver Design.

By R. T. BEATTY, M.A., B.E., D.Sc.

Reprinted from "The Wireless World."

"Radio Data Charts" provide designers of wireless apparatus with a ready and convenient means of solving problems without having recourse to complicated formulæ and mathematics.

By the use of the charts it is possible to tackle all the more familiar problems in radio receiver design; such as, for example, finding the relationship between inductance capacity and frequency, and working out the design of high frequency transformers. All keen amateurs will appreciate this helpful book.

Price 4/6 net. By post 4/10.

(39 CHARTS and more than 50 Diagrams.)

From all leading booksellers or direct from the Publishers.

Published from the Offices of "THE WIRELESS WORLD."

ILIFFE & SONS LTD., Dorset House, Tudor St., London, E.C.4.

W.W.93

"Within 24 hours"

*A letter from a recent advertiser in
"THE WIRELESS WORLD."*

"... Doubtless you will be pleased to learn that my advertisement in 'The Wireless World' brought me a good customer within twenty-four hours.

I am highly satisfied with the results of advertisements in your excellent journal."

John Harrison,
72, Oakwood Road,
Hampstead Garden Suburb,
London, N.W.11.

If you wish to dispose of or purchase any wireless apparatus — advertise in the Miscellaneous Columns of "THE WIRELESS WORLD."



W.W. 50.

The AMATEUR³ PHOTOGRAPHER & CINEMATOGRAPHER

Incorporating "THE NEW PHOTOGRAPHER"



—for
All Camera Users!

Every camera user can get more pleasure out of photography and better results by reading "The Amateur Photographer" regularly.

The "A.P." caters for all photographers, including beginners and advanced workers, and contains Lessons for Beginners; Free Criticism of Readers' Prints; Answers to Queries; Regular Competitions and a weekly Art Supplement of particular interest to pictorial workers.

Every Wednesday 3^d.

ILIFFE & SONS LTD.
Dorset House, Tudor Street, London, E.C.4

W.W. 37.

Mention of "The Wireless World," when writing to advertisers, will ensure prompt attention.

CAV ALL POSITION NON-SPILLABLE



*The Original
Jelly Acid
Battery.*

*The Perfect
Battery for
all Portables*

It is only natural that the C.A.V. Jelly Acid Battery should have its imitators. It is a compliment that reflects the marvellous success of a battery already standardised in many popular portable sets, and which is invariably recommended in the constructional articles of the Wireless Press. The preparation of the special C.A.V. Jelly Acid remains the secret of our chemists, however, and is not to be found in any other battery. Its use in conjunction with the special container provides a battery which is the lightest and most compact obtainable. It gives maximum capacity in any position, and is absolutely unspillable. It is the battery for your portable set.

Our latest Radio Battery Catalogue No. T3 will gladly be forwarded on application.

CAVandervell & Co. Ltd.
ACTON, LONDON, W. 3

C.A.V. H.T. Accumulator

We shall be glad to send you particulars of the C.A.V. H.T. Accumulator supplied in 10 volt units or 30 volt groups of 2,500, 5,000 and 10,000 milliamp. hours capacity.

This entirely new and original H.T. is suitable for all classes of Receivers.

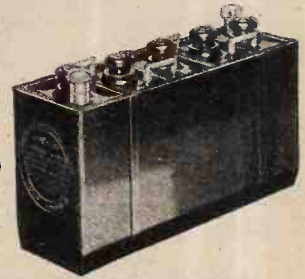

The bridge from A.C. to D.C.

Change over by means of the metal bridge—
strong, reliable and durable—

THE



METAL RECTIFIER

NOTHING TO WEAR OUT AND NO PERIODICAL REPLACEMENTS—there are no filaments, moving parts, or chemical action.

EASY TO INSTALL—simple wiring circuits. **EFFICIENT IN SERVICE**—true output wave form facilitates smoothing.

There is a rectifier for every type of mains unit. Whether you construct, or purchase complete, an eliminator, mains set, or battery charger, for your own satisfaction see that a Westinghouse Metal Rectifier is used.

Have you had your copy of "The All Metal Way, 1930"?

This 32-page book of instructions and circuits is invaluable to all users and prospective users of A.C. mains. A copy will be sent on receipt of a 2d. stamp.

The Westinghouse Brake & Saxby Signal Co., Ltd., 82, York Rd., King's Cross,
London, N.1.

LISTEN AT LESS COST



"D" SERIES
For Low Tension
Prices per 2 volt cell

Type DTG	
20 amp. hrs.	4/6
Type DFG	
45 amp. hrs.	8/6
Type DMG	
70 amp. hrs.	11/-
Type DHG	
100 amp. hrs.	14/6

Nowadays most valves take far less current than they used to take. Batteries could now last for a very long time on one charge if only they would not deteriorate when not charged frequently. Always a step in front, Exide have designed a new type of low tension battery with special plates to give slow discharges for long periods without harm. With one of these batteries—known as the "D" series—listening will cost you much less—less in money—less in trouble.

Exide

THE LONG LIFE BATTERY

Obtainable from Exide Service Stations and all reputable dealers
Exide Service Stations give service on every make of battery
Exide Batterie, Clifton Junction, near Manchester. Branches at London, Manchester, Birmingham, Bristol and Glasgow



Complete with 10 1/2" baseboard and removable baffle board.

USE THE



"MAJOR" CABINET for your RADIO-GRAM

Especially suitable for
**MULLARD ORGOLA,
OSRAM MUSIC MAGNET,**
and for panels up to 18" x 8"
Loud Speaker compartment is 18" x 18" x 18 1/2"
Oak **£7:10:0** Mahogany **£7:15:0**
Call and see full range of Cameco cabinets at new
London Showrooms:
GARRINGTON MANUFACTURING CO., LTD.
NEW SHOWROOMS:
24, Hatton Garden, London, E.C.1 ♡4609

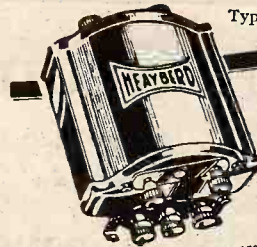

Type W. 14. Price 21/-

Specially built
for Mains Units



The Power Transformer in Mains apparatus controls the current as it flows through the circuit. For this important work you should use the best. Use Heayberd Power Transformers! And get the steady uniform output so vital to the efficiency of your receiver.

For literature write:—
F. C. HEAYBERD & Co., 10 Finsbury St., E.C.2
Telephone: Clerkenwell 7220.

PARFAIT

THE PERFECT
EBONITE PANEL
ONE QUALITY ONLY
— THE BEST —

SUPPLIED IN SIX FINISHES | Matt Semi-Polished Mahogany Highly Polished Black.
Cube Surface Highly Polished Mahogany Semi-Polished Black
Stocked by most Wireless dealers. If any difficulty in obtaining locally write or name of nearest stockist to:
H. B. POTTER & Co., Ltd., Station Buildings, ROCHDALE.

Mention of "The Wireless World," when writing to advertisers, will ensure prompt attention.

The Yachting World and Motor Boating Journal

The Leading British Yachting Journal

"THE YACHTING WORLD" deals with yachts and boats of all types and tonnages, whether on the sea or inland waters. Every aspect of yachting and motor boating is covered in an attractive and interesting manner.

Every Friday 6D.

LILFFE & SONS Ltd., Dorset House, Tudor St., London, E.C.4

THE NEW "PORTABLE" COMBINED D.C. UNIT (H.T. with L.T. CHARGER)

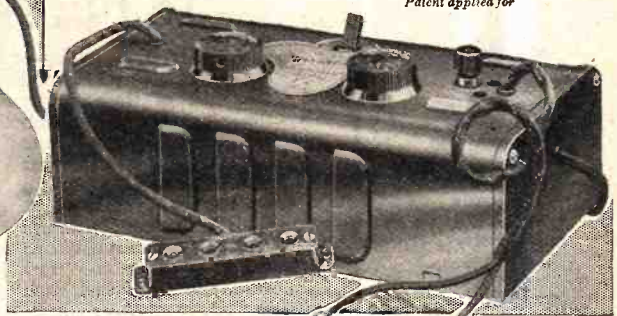

SPECIFICATION—Combined Model for D.C. Mains.

INPUT VOLTAGE—200/250 volts.

SIZE—9 in. × 5 in. × 3½ in.

H.T. OUTPUT—130 volts at 20 m/a.

H.T. TAPPINGS—Two Continuously Variable and one Power.

(One Variable is specially compensated for Screened Grid or Anode Bend operated valves, and may also be used in the usual manner.)

L.T. OUTPUT—A specially constructed adaptor is provided which allows the use of an ordinary electric lamp for charging the accumulator. This lamp may be used at the same time for lighting purposes, without any alteration whatever to existing wiring.

By this means 2-, 4-, or 6-volt accumulators may be charged at a rate of from ½ amp. to 1 amp., according to the lamp used.

PRICE £4:5:0

Write for leaflet giving full particulars, and for Free Art Booklet "Radio from the Mains."

**Fits inside any Portable
-and is equally suitable
for all popular 2-, 3-, and
4-valve receivers**

REGENT RADIO SUPPLY CO. 21, Bartlett's Bldgs, Holborn Circus, London, E.C.4 Telephone Central 8745/7

**Today more than ever, the 4 years' old
Celestion C.12 is recognised as
Radio's Richest Voice.**

The Celestion C.12 is the one Loud-speaker which has withstood four years' competition and is actually selling today in increasing numbers.

See and hear it for yourself and you will realise why it is radio's greatest prize.

Oak £5. 12. 6. Mahogany £5. 17. 6. Walnut £6. 6. 0.
Hear also the new Celestion Z Models, from £7. 15. 0

Write for interesting booklet, on sound reproduction and particulars of the new Celestion Electrical-Gramophone & Radio-Gramophone

CELESTION LTD.
KINGSTON - ON - THAMES.

London Showrooms: 106, Victoria St., S.W.1

CELESTION

The Very Soul of Music

**"I wish I'd fitted
a Microfu"**

The "Microfu" is made in various ratings, from 5 milli-amperes to 1000 milliampères, and is suitable for the protection of valves, wireless sets, eliminators and all instruments taking small currents. It blows to within 10% of its rated value and operates with the extreme rapidity of 1/1000th second.

The "Microfu" has behind it the backing of the whole T.C.C. organisation, with its unrivalled and world-wide reputation.

Prices:
Cartridge from 2/-.
With holder from 2/6.

T.C.C. MICROFU

BACKED BY THE T.C.C.

Advt. Telegraph Condenser Co. Ltd., Wales Farm Rd., N. Acton, London, W.3.

TESTS OF TIME

Built in
1843..

... by Mr. E. H. Bailey—Nelson's Column has stood the test of time for 87 years! The Telegraph Condenser Co. built the now famous "Condenser in the green case" over a quarter of a century ago. This famous condenser and Nelson's Column have one thing in common—they stand the test of time. Each T.C.C. condenser is individually tested before it leaves the factory. You can be sure—when you ask for a condenser of a certain capacity, if it's T.C.C. you get it!—they are accurate to a point almost of infallibility. Don't put up with inefficient condensers in your Set, there's no excuse now because the T.C.C. condenser costs no more. And remember, they are guaranteed.



The condenser illustrated is 800 volt D.C. test.
400 D.C. working 8/6

NELSON'S COLUMN

ADVERT. OF THE TELEGRAPH CONDENSER Co. Ltd. N. ACTION, W. J. 4706

Ask for an EDISWAN— the better-service Accumulator



Ediswan accumulators are economical to maintain—they're built that way.

First cost is low and the care taken to produce a really efficient and thoroughly reliable cell is a guarantee of maximum life per charge and 100% service.

Ediswan accumulators are made in all types and sizes—ask your dealer for a price list.

Major Loten, 70 Ampere	hours	-	13/-
Minor Loten, 45 Ampere	hours	-	8/-
Little Loten, 20 Ampere	hours	-	4/3
Midget Loten, 12 Ampere	hours	-	2/9

EDISWAN RADIO ACCUMULATORS



THE EDISON SWAN ELECTRIC CO., LTD.,
123/3, QUEEN VICTORIA STREET, LONDON, E.C.4.
Showrooms in all the Principal Towns.

B.70

Mention of "The Wireless World," when writing to advertisers, will ensure prompt attention.

The Wireless World

AND
RADIO REVIEW
(18th Year of Publication)

No. 558.

WEDNESDAY, MAY 7TH, 1930.

VOL. XXVI. No. 19.

Editor: HUGH S. POCOCK.
 Assistant Editor: F. H. HAYNES.
 Editorial Offices: 116-117, FLEET STREET, LONDON, E.C.4
 Editorial Telephone: City 9472 (5 lines).
 Advertising and Publishing Offices:
 DORSET HOUSE, TUDOR STREET, LONDON, E.C.4.
 Telephone: City 2847 (13 lines). Telegrams: "Ethaworld, Fleet, London."
 COVENTRY: Hertford Street. Telephone: 5210 Coventry.
 BIRMINGHAM: Guildhall Buildings, Navigation Street.
 Telegrams: "Autopress, Birmingham." Telephone: 2970 and 2971 Midland.
 MANCHESTER: 260, Deansgate. Telephone: 8970 City (4 lines).
 Telegrams: "Iliffe, Manchester."
 GLASGOW: 101, St. Vincent Street, C.2. Telephone: Central 4887.
 Telegrams: "Iliffe, Glasgow."
 PUBLISHED WEEKLY.
 Subscription Rates: Home, £1 1s. 8d.; Canada, £1 1s. 8d.;
 other countries abroad, £1 3s. 10d. per annum.
 Entered as Second Class Matter at New York, N.Y.
 As many of the circuits and apparatus described in these pages are covered by
 patents, readers are advised, before making use of them, to satisfy themselves
 that they would not be infringing patents.

CONTENTS OF THIS ISSUE.

	PAGE
EDITORIAL VIEWS	473
POWER PENTODE-TWO. BY W. J. G. PAGE	474
POWER GRID DETECTION. BY W. T. COCKING	479
CURRENT TOPICS	484
PRACTICAL HINTS AND TIPS	486
LABORATORY TESTS ON NEW APPARATUS	488
BROADCAST BREVITIES	489
WIRELESS THEORY SIMPLIFIED, PART XXIX. BY S. O. PEARSON	490
THE CRYSTAL RECEIVER FOR TELEVISION—IS HERE?	493
CORRESPONDENCE	494
READERS' PROBLEMS	495

POWER GRID DETECTION.

WHILST enormous strides have been made during the past few years in the development of circuits for high-frequency amplification, assisted by the improvements in valves, by the introduction of neutralising and, more recently, by the production of the screened-grid valve, yet the detector stage, it must be admitted, has not received any large measure of attention. After we leave the detector stage we find that low-frequency amplification has progressed both in the design of three-electrode valves and the pentode, and in the improvement of transformers and other apparatus associated with the post-detector side.

Comparatively recently, however, the detector has received some measure of consideration, and a development which promises to be of much importance in the future is the principle which has come to be known as power-grid detection. The theory of power-grid detection has been a little in advance of its practical application, for the reason that it is only just recently that valves have been produced which are capable of doing

justice to the principle involved. In general, the limitations of grid detection in the past have been the inability of the stage to handle anything in excess of a very small input without distortion resulting, and where it was desired to increase the sensitivity the usual values of grid leak and condenser which had to be employed tended to result in a cut-off of high notes, so that a compromise had to be effected between sensitivity and quality. In power-grid detection these disabilities can be avoided, and very much greater input can be handled. The valves at present designed for power-grid detection require a high anode potential, so that for the moment the system is probably not easily adapted except where A.C. is available and the set is operated from the mains.

Readers will recollect that under the title of "A New Method of Detection, Using A.C. Valves," information bearing on this subject was contained in an article which appeared in the issue of *The Wireless World* of January 8th this year, and in the present issue the subject is discussed at some length under the title of "Power-Grid Detection," whilst a description also appears of what we believe to be the first receiver embodying these principles in the detector stage and showing how the principle may be applied in practice. Considered in comparison with other receivers of an equivalent number of valves, the results from this set designed in *The Wireless World* laboratory indicate a distinct advance.

RADIO PATENTS.

READERS will recollect that in the issue of April 16th we commented on an interesting patent situation which had arisen as the result of an offer by Standard Telephones and Cables, Ltd., to license British manufacturers of broadcast receivers under a number of their patents, and we suggested then that the manufacturer might find himself in a somewhat embarrassing situation if he had to decide between taking out a licence with Standard Telephones or with Marconi's, whose general licence was available in conjunction with the Gramophone Company.

We now learn that a joint licence agreement is likely to be available to the manufacturer under which, in return for the tribute of reasonable royalties, he will have at his disposal the patents of Standard Telephones, the Marconi Company, and the Gramophone Company, in so far as they relate to broadcast receivers, whilst, in addition, it is hoped that the agreement may carry with it certain additional privileges in the way of advice and assistance on technical problems with which the manufacturer may find himself confronted.

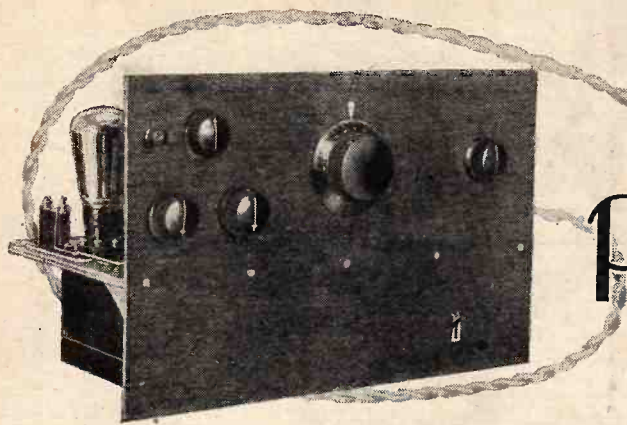

Power Pentode-Two

By W. I. G. PAGE, B.Sc.

A Two-valve All-mains Receiver for Local Station Quality Reception.
Power Grid Detector Coupled to a High-voltage Pentode.

THERE are probably a number of listeners who are prepared to rest content with transmissions from their local stations, and who have no desire to search the ether for programmes from afar. Whilst it must be admitted that they are in the minority among home constructors, the majority who prefer long-range sets have been well catered for in *The Wireless World* by such receivers as the New Kilo-Mag Four and the New Foreign Listener's Four. The opportunity has been taken of designing a powerful short-range set around the new power grid detector, the principles of which are lucidly described elsewhere in this issue. When new circuits are evolved speculation is rife and extravagant claims are often made; it is therefore as well that the advantages and limitations of this detector should be briefly discussed.

Distortionless Grid Detector Explained.

With the conventional leaky-grid detector there is considerable high-note loss, due to the fact that the necessary values of leak and condenser to give good sensitivity also shunt away the higher audio-frequencies. Moreover, with 60 volts H.T., the signal that is rectified on the grid is applied to a very curved anode characteristic, and anode rectification in opposite phase to that of the grid is produced unless an extremely small signal is dealt with. This can clearly be seen by reference to Fig. 2. If the signal could be applied after rectification on the grid to the 150-volt anode curve shown in the figure, the output would manifestly be nearly proportional to the input, and curvature distortion in the anode circuit would be absent.

From the foregoing it will be clear that one of the first considerations in linear grid detection is a high anode voltage. A valve used under these conditions at approximately zero grid voltage passes a heavy anode current, and it is as well to ascertain from the makers whether the watts dissipation is such that the life of the valve will not be shortened. The valve used in this receiver is an AC/HL with a 4-watts dissipation limit, so that with 8 mA. at 140 volts H.T. (see Fig. 1) there

is a safe wattage of just over 1. The Marconi and Osram MHL4 and the Mullard 354V valves also have the same dissipation limits, and can be used as power grid detectors with 150 volts actually on the plate. It is a happy coincidence that with A.C. valves grid current flows when the grid and cathode are joined together, no positive bias is thus required. Those who must perforce use battery valves will find the power grid detector rather extravagant; nevertheless, the considerable improvement in quality, with even 120 volts actually on the plate, may be considered worth while. It must not be for-

SPECIFICATION.

- Power grid detector with high anode voltage and modified grid constants giving linear output with comparatively large inputs.
- Low-frequency coupling with a stage gain of about 135 and provision for frequency correction.
- Power output from high-voltage pentode about 1,500 milliwatts with correct loud speaker load.
- Tone control by capacity and variable resistance across the output choke.
- Volume control at both pre- and post-detector positions.
- Grid bias obtained automatically by voltage drop across a resistance.
- Reaction controlled by differential condenser.
- Selectivity to suit different localities by the use of interchangeable inductances for the rotor of a variocoupler. A variable series aerial condenser is also provided. One dial tuning.

The set as described is arranged for the medium broadcast band only, but with reservations as explained in the text a dual-range coil can be used without alteration to the wiring.

gotten that a small positive potential should be given to the grid with ordinary filamented valves. Provided that the watts dissipation limit is not exceeded, the type of valve represented by the L.610 in the battery class would appear to have the right characteristics for this form of detection.

Loud Speaker Direct from Detector possible.

Up to the present we have only discussed the voltage directly applied to the anode, and until low-frequency transformers are designed with primaries having an

Power Pentode-Two.—

inductance of, say, 70 henrys when passing 10 mA., the parallel-feed method must be used. This necessitates a resistance in the anode circuit, which again adds to the volts required from the H.T. source. It will be seen from Fig. 1 that the rectified output from the eliminator before smoothing must be no less than 330 volts to realise a linear output from the AC/HL. At the present stage of development the power grid detector can only be used economically where A.C. mains are available. Alternatively with this type of supply, which is being used more extensively every day, the new detector has great possibilities, for it can be shown¹ that the power output in milliwatts is one-quarter that obtained when the valve is used with the same H.T. voltage as an amplifier suitably biased:

It is reasonable to prophesy that A.C. sets will be designed with the loud speaker connected directly in

the conventional values of leak and condenser is necessary if considerably larger H.F. inputs are impressed. With the ordinary leaky-grid detector the input must be kept so small that grid current is flowing all the time, but with large impulses grid current only flows during the positive half-cycle. The action in the latter case is much the same as that of an anode bend detector. The condenser and leak must have a time constant such that the modulation envelope is faithfully followed and the process is similar to that described by the author in an article entitled "The Valve as an Anode Bend Detector."² In the article in this issue already referred to, it is pointed out that the grid condenser and leak, to conform to the necessary time constant, should not exceed 0.0001 mfd. and 250,000 ohms respectively, and these values have been used in the present receiver.

Grid current characteristics are straighter, and have shorter curved portions, than anode curves, which

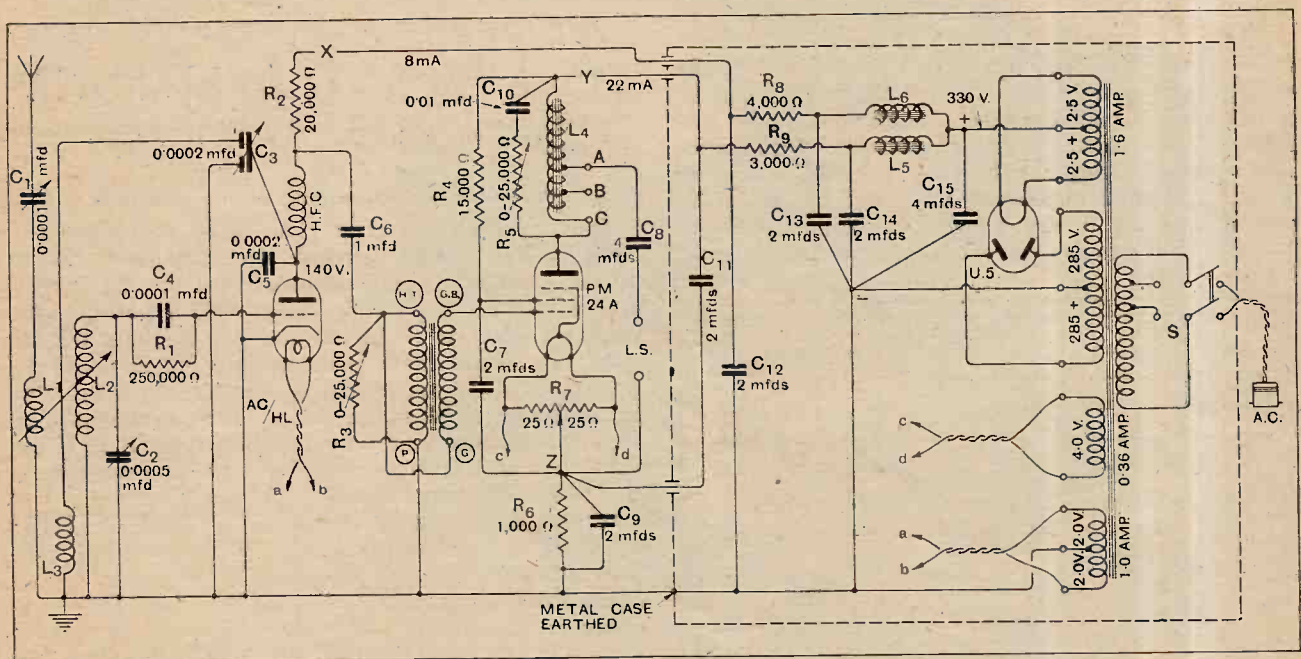

Fig. 1.—The circuit embodies a high-voltage linear grid detector followed by a parallel-fed auto-coupled transformer which in turn is linked to a power pentode. R₃ is the post-detector volume control and R₅ C₁₀ the variable tone control. Automatic grid bias for the pentode is obtained through R₆. C₁₃, C₁₄ and C₁₅ form the elements of a condenser block with common earth terminal. L₄ and L₅ are gapped chokes of about 55-henrys inductance with 20 mA. D.C.; L₄ is tapped. The inductance of L₆ is about 40-50 henrys with 8 mA. D.C. The L.F. transformer has an effective step-up ratio of 8 : 1.

the output of the detector, for a valve with an amplifying output of 1,600 milliwatts would give 400 milliwatts as a detector—a sufficient volume for a moderate sized room. This assumes, of course, that the maximum grid swing that can be accommodated is given to the valve. It can also be shown that a valve employed as a power grid detector will handle half the grid swing possible under amplifying conditions using the same anode voltage.

Now that conditions for linear anode amplification in the grid detector have been given consideration, it would be as well to discuss the grid circuit to see what change

means that so long as the H.T. voltage is high enough to ensure a reasonably straight plate characteristic, the power grid detector will give more linear rectification than the anode bend detector, and certainly will be considerably more sensitive. The deeper the modulation the more important is the marked absence of gradual bend in the curve. The damping of the input circuit is rather serious, and appears to be due partly to grid-filament conductivity in the valve, which may add 100,000 ohms in parallel with the dynamic resistance of a coil perhaps of similar value, and so halve the effective resistance of the tuned circuit at resonance. There

¹ See *Radio Broadcast*, April and May, 1929.

² See *The Wireless World*, March 13th and 27th, 1929.

LIST OF PARTS.

- 1 Variable condenser, 0.0001 mfd. (Polar, "Volcon").
- 1 Variable condenser, 0.0005 mfd. with slow-motion dial (Polar, "Ideal").
- 1 Differential condenser, 0.0002 mfd. (Magnum).
- 1 Fixed condenser, 0.0002 mfd. mica (T.C.C. Type 34).
- 1 Fixed condenser, 0.0001 mfd. with clips, mica (T.C.C. Type 34).
- 1 Fixed condenser, 0.01 mfd. mica (T.C.C. Type 34).
- 1 Condenser block, 8 mfd. 4 mfd. + 2 mfd. + 2 mfd.; 750 v. + 500 v. + 500 v. D.C. test (T.C.C. Type 3.BI).
- 1 Fixed condenser, 1 mfd. 500 v. D.C. test (Loewe).
- 6 Fixed condensers, 2 mfd. 700 v. D.C. test (Loewe).
- 1 L.F. transformer, 1:7 ratio (Ferranti AF6).
- 1 Potentiometer, 50 ohms (Igranac).
- 1 Decoupling resistance, 1,000 ohms (Groves).
- 4 Resistances with holders, 3,000 ohms., 4,000 ohms, 15,000 ohms., 20,000 ohms (Ferranti).
- 1 H.F. choke (Bulgin, "Standard").
- 1 2-pole Mains Switch (Bulgin, S.56).
- 1 Panel dial indicator (Bulgin).
- 2 Variable high resistances, 0-25,000 ohms (Electrad-Royalty, Rothermel).
- 1 Grid leak, vacuum-type, 250,000 ohms (Ediswan).
- 2 5-pin Valve holders (Lotus).

- 1 5-pin Valve holder with angle bracket (W. B. "Universal").
- 1 Mains transformer; 285 v.+285 v.; 2.5 v.+2.5 v. 1.6 amp.; 2.0 v.+2.0 v. 1.0 amp.; 4.0 v. 0.36 amp. State mains voltage and frequency when ordering (Parmeko, Type 2A/3).
- 1 Smoothing choke, 110-henrys (Pye).
- 1 Smoothing choke, 70-henrys, gapped (Savage, Type LC. 36G).
- 1 Pentode output choke, 70-henrys, gapped and tapped (Savage, Type LC. 36 PG.).
- 1 Coil for medium waves with aerial rotor and reaction windings (Colbern, Type R.M.).
- 2 Panel brackets, size 3 1/2 in. x 3 1/2 in. (Collett).
- 4 Terminals, aerial, earth, speaker, speaker (Belling Lee, Type "R").
- 1 Rectifying valve, U.5 (Marconi or Osram).
- 1 Valve, AC/HL (Mazda).
- 1 Valve PM24A (Mullard).
- Paxolin panel, mahogany finish, 16 in. x 10 in. x 3/16 in.
- Paxolin terminal strip, 7 x 1 1/2 x 1/2 in.
- Metal box for eliminator, 12 x 8 1/2 x 3-13/16 in. (22 or 24 gauge tinned plate (Ritherdon).
- Cabinet, wood (Cameco); metal (Ritherdon).
- Twin flex, lamp adaptor, Systoflex, wire and 5-ply wood, etc.
- Approximate cost (excluding cabinet and valves), £12 15s.

In the "List of Parts" included in the descriptions of THE WIRELESS WORLD receivers are detailed the components actually used by the designer, and illustrated in the photographs of the instruments. Where the designer considers it necessary that particular components should be used in preference to others, these components are mentioned in the article itself. In all other cases the constructor can use his discretion as to the choice of components, provided they are of equal quality to those listed and that he takes into consideration in the dimensions and layout of the set any variations in the size of alternative components he may use.

is also a marked reverse reaction effect produced by the anode-grid capacity of the valve. Whilst this can be minimised by a condenser from anode to cathode, it is found that considerable capacity in this position increases anode rectification efficiency, as could be seen by interposing a milliammeter at X. A local transmission reduced the 8 mA. to, say, 7 mA., but a large capacity at C₅ caused loud signals to give a slight upward kick of the

needle. A compromise was struck, C₅ being made 0.0002 mfd. The low-value grid leak R₁ has been shunted across C₄ to avoid further damping of the tuned circuit.

Pre- and Post-Detector Volume Controls.

The power grid detector gives of its best when the input is large; it is therefore necessary, in order to prevent overloading the pentode when the set is used near a broadcasting station, to provide a post-detector volume control R₃. As the coupling resistance R₂ is small, and, furthermore, as the working impedance of the AC/HL is about 10,000 ohms, the maximum value of R₃ need not exceed 25,000 ohms. The signal should be kept at resonance, and volume adjusted by R₃. If the signal has such a large amplitude that the detector is overloaded, the series aerial condenser C₁ should be reduced and C₂ readjusted. This not only cuts down the input from the aerial but enhances selectivity. The large A.C. component in the anode circuit of the detector valve causes reaction to be harsh if a two-electrode variable condenser is used to feed back energy. A differential condenser C₃ has been pressed into service, and certainly assists in making the control smooth. Hand-capacity effects are absent, as a large area of the stators is at earth potential.

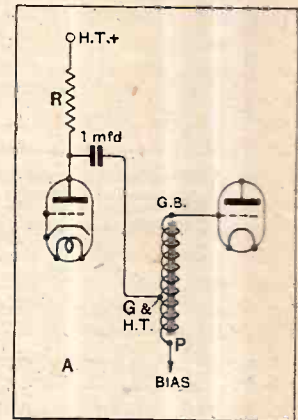

Fig. 3. — The additional step-up effect as a result of auto-coupling an L.F. transformer can best be understood when the circuit is redrawn as above. Circuit A of Fig. 4 is shown.

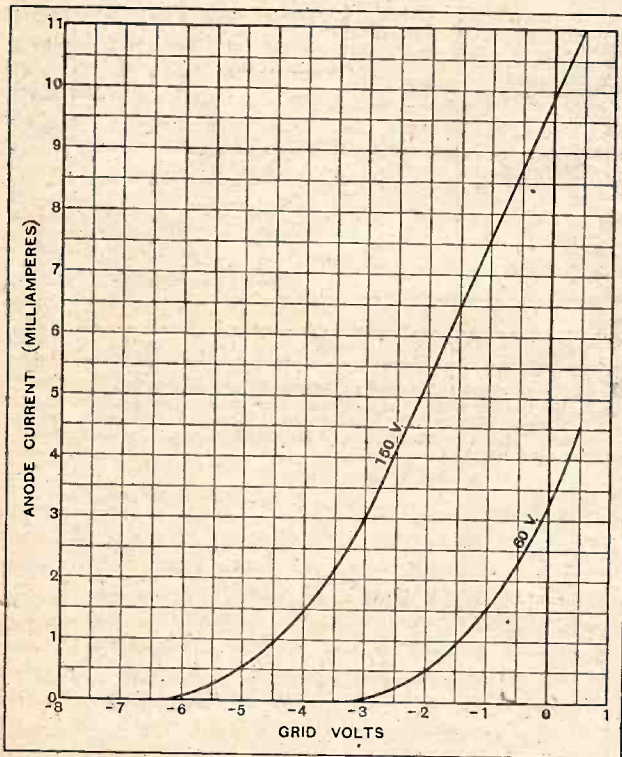

Fig. 2.—The impossibility of obtaining a large undistorted output from a conventional leaky-grid detector with 60 volts H.T. can be appreciated by examining the above anode curve of an AC/HL valve for that voltage. The 150-volt curve is much straighter and permits of comparatively large inputs without causing anode rectification.

Frequency Correction of the L.F. Amplifier.

Having given the detector a healthy signal, there should be in its anode circuit a rectified output worthy of a good intervalve coupling. It was decided to use a Ferranti AF6 transformer having

Power Pentode-Two.—

a nominal ratio of 7:1, but it was obvious that a reduction from 85 to 35 henrys with the passage of 8 mA. D.C. precluded a direct connection of the primary in the anode circuit. The resistance filter-feed method was adopted, using a 20,000-ohm coupling resistance (R_2) and a 1 mfd. coupling condenser C_6 . The full 85 henrys have thus been preserved. If R_2 is increased there is less linear detection, due to a further drop in anode volts, but at the same time there is greater L.F. magnification. If R_2 is reduced it is difficult to stop motor-boating.

When an L.F. transformer is parallel- or filter-fed it can also be auto-coupled so as to give an increased step-up of $N+1$, or a reduced step-up of $N-1$ (where N is the nominal step-up ratio), in accordance whether the primary is connected to assist or to oppose the secondary. The additional step-up with auto-coupling will be better understood by examining the circuit of the AF6 as redrawn in Fig. 3. There is a further important effect due to the flow of capacity currents between adjacent windings at different potentials; this affects the response curve at the upper frequencies. We are in a position to choose whether we shall have a large L.F. stage gain and a falling characteristic or a reduced gain and a rising characteristic. We can also control the bass response³ by altering the value of C_6 .

The author is indebted to Messrs. Ferranti for having prepared stage amplification curves for the AF6 preceded by various valves (see Fig. 4). Circuit A, where the primary assists the secondary and the step-up ratio is $N+1:1=8:1$, produced curves 1 and 3, whereas circuit B, where the ratio is $6:1$, causes a rising characteristic (see curve 2), usually so difficult to obtain but so necessary with triode output. The tendency to accentuation of the higher frequencies with the pentode makes the upper frequency response of curve 1 entirely satisfactory so that circuit A is used in the receiver. Due to the combined properties of the pentode and the falling characteristic of curve 1, a reasonably level characteristic is obtained throughout the range of audio-frequencies likely to be reproduced by a loud speaker, and the L.F. stage amplification is maintained at the remarkable level of about 135. Although with a large input to the detector it will be obvious that the volume control R_3 will have to be used, the large L.F. stage

³ See *The Wireless World*, December 11th, 1929, p. 644 and February 12th, 1930, p. 171.

gain is useful when the receiver is operated from 30 to 50 miles from the local station.

The Truth about the Pentode.

Now we come to a point where many readers will probably want to take the author to task for using a pentode and claiming high quality with it. Properly used it is believed that the pentode will give as satisfactory reproduction as a triode, and it is quite certain that no valve will give as many milliwatts output per volt input. It is a comparatively new type of valve, and is only now becoming properly understood. The rule of the triode that the speaker impedance must be twice that of the valve must be forgotten if we accept the maker's figure of 53,000 ohms as the working A.C.

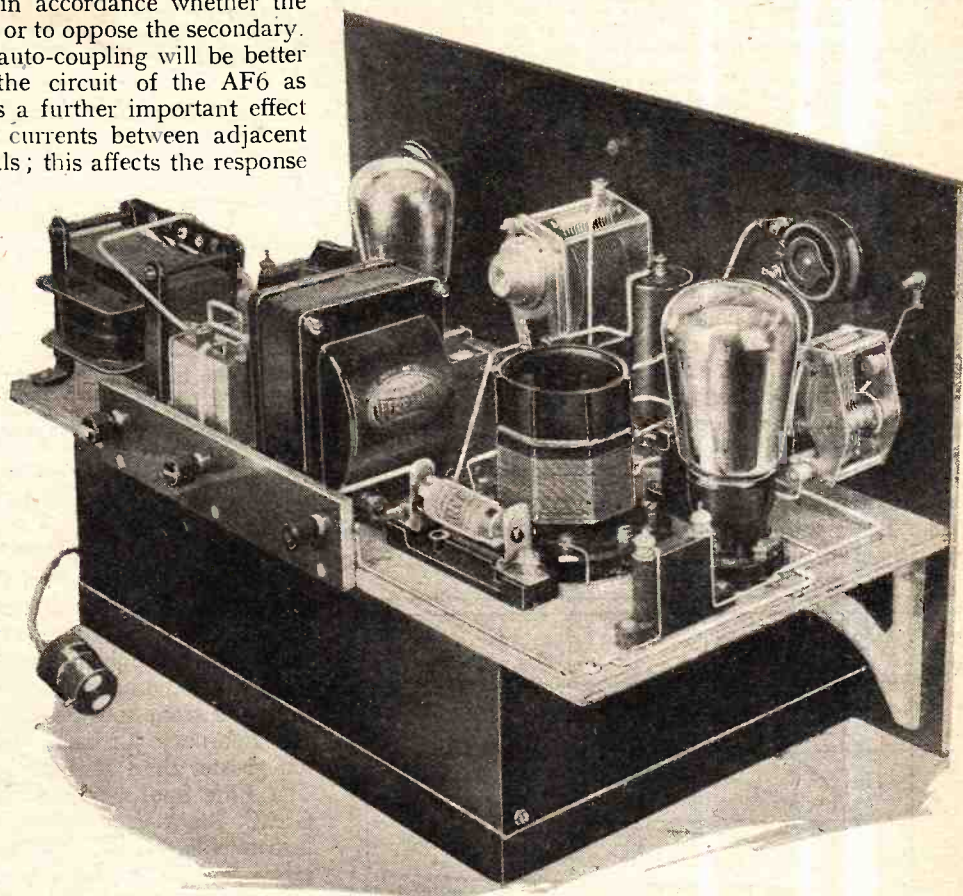

Rear view of receiver from the detector input end.

resistance of the P.M.24A. Load lines cutting the operating point OP are given in Fig. 5 for a working anode and screen voltage of 200 and for a negative bias of 20 volts (roughly the conditions under which the valve is working in the "Power Pentode-Two"). It can be seen that a 7,000-ohm load—less than 1/7th the nominal A.C. resistance of the valve—gives fairly equal intercepts between $E_g=0$ and $E_g=-40$. This means that if a speaker could be made with an impedance maintained at 7,000 ohms at all frequencies the quality of reproduction without any correcting

Power Pentode-Two.—

devices would be as perfect as that obtainable from any triode.

Load lines for many pentodes have been worked out, and when only an unobjectionable percentage of third-harmonic distortion is left it is found that the load always lies between 5,000 and 11,000 ohms. In an article in *Experimental Wireless* (March, 1929) B. C. Brain pointed out that either with a pentode or triode the load resistance should be twice the value of the A.C. resistance of the valve when the anode current is at its maximum peak value. At I_{max} in Fig. 5, on the "knee" of the characteristic, the A.C. resistance of the valve is 5,000-6,000 ohms. It may thus be necessary in future only to consider the impedance of a pentode at I_{max} . The valve certainly behaves like a moderately high-impedance output triode, and requires a step-down transformer to give good reproduction of the bass with the average loud speaker designed to follow a 2,000-ohm triode. The choke L_1 is tapped to give a 1:1, a 2:1 step-down and an intermediate ratio. The loud speaker may be

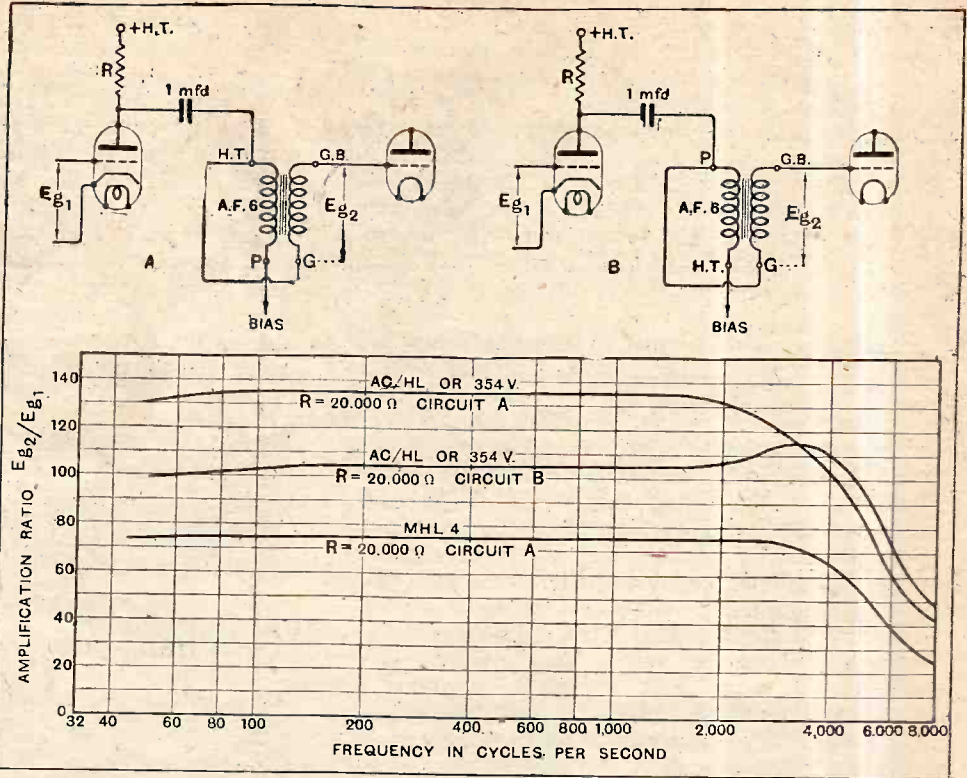

Fig. 4.—Low-frequency stage gain curves for an auto-coupled AF6 transformer preceded by different valves. In circuit A, the step-up is about 8:1, in circuit B, 6:1. For frequency correction of the upper register a rising or falling characteristic can be chosen at will. Note in the case of curve 1 the very large stage gain of 135.

connected through C_s to A, B or C, according to its impedance, or, better still, by trial and error.

Tone Control.

Reed-driven speakers with impedances of, say, 30,000 ohms at the higher frequencies when used with the P.M.24A would produce serious distortion and over-voltages with comparatively small inputs, as can be seen from the 30,000-ohm load line of Fig. 5. Choice should be made from speakers tested by *The Wireless World* (see February 5th issue) and shown to have impedances not greater than about 10,000 ohms at any frequency. The Blue Spot type 66K, Grawor balanced armature, G.E.C. Stork and the Kukoo are examples of suitable instruments. The step-down transformer artificially raises the speaker impedance, and there may be still a little shrillness, even with the speakers already referred to. This is overcome by shunting the "primary" of the choke with a resistance and condenser to act as an impedance-limiting device as the frequency rises. By making the resistance variable an excellent tone control results ($R_s C_{10}$). In brief, to obtain a large, undistorted output from a pentode with a loud speaker designed for a triode, choose the speaker from amongst those in which the impedance does not rise much above 10,000 ohms at any frequency, use a step-down choke of high inductance or a transformer to look after the bass and prevent undue accentuation of the treble by a resistance and condenser across the output device. Constructional details of the set will be given in next week's issue.

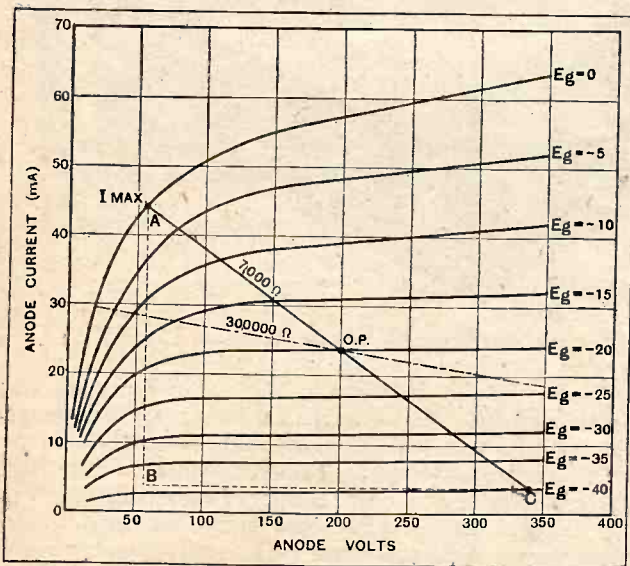
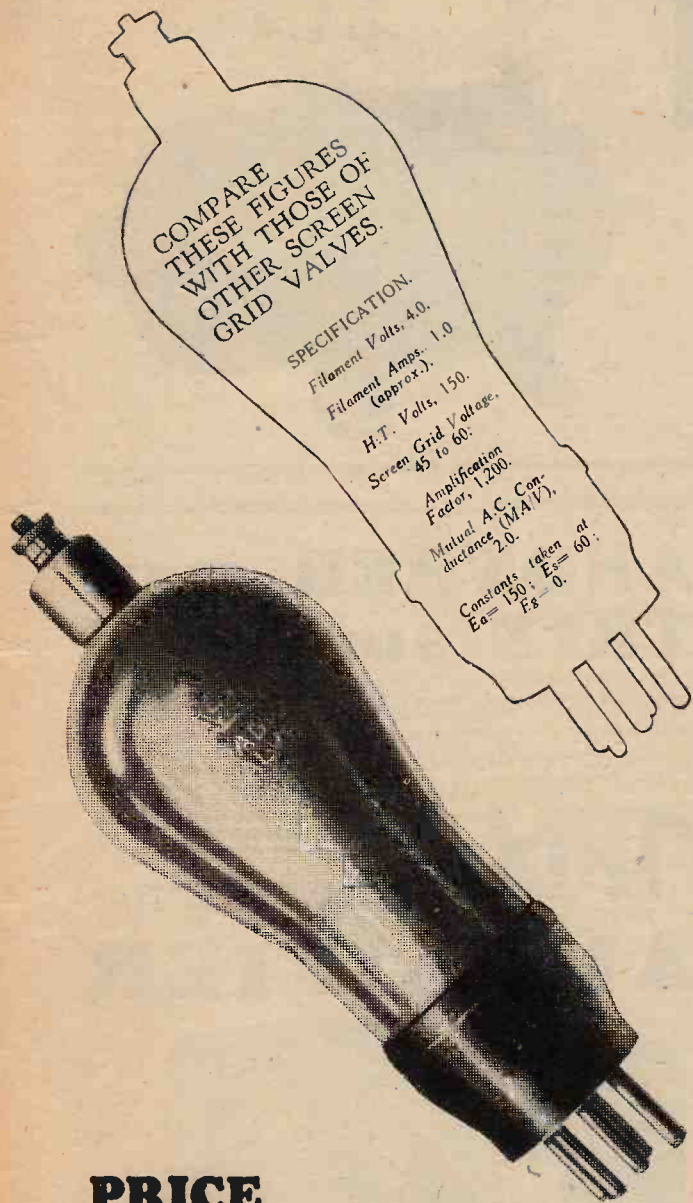

Fig. 5.—Anode volts—ano-de current curves of the high-voltage pentode (P.M.24A). Distortion and serious over-voltages arise when using a loud speaker which has a high impedance at any frequency, as can be seen by examining the 30,000-ohm load line. The load which gives the greatest undistorted output is about 7,000 ohms.

The MAZDA AC/SG is at least TWICE as good as any other screened grid valve.



COMPARE THESE FIGURES WITH THOSE OF OTHER SCREEN GRID VALVES.

SPECIFICATION:
 Filament Volts, 4.0.
 Filament Amps., 1.0 (approx.).
 H.T. Volts, 150.
 Screen Grid Voltage, 45 to 60.
 Amplification Factor, 1,200.
 Mutual A.C. Conductance (MAY), 2.0.
 Constants taken at $E_a = 150$; $E_s = 60$; $E_g = 0$.

The Mazda A.C./S.G. has the highest amplification factor and mutual conductance of any screen grid valve, and its performance in a H.F. amplifier is absolutely unequalled.

The characteristics printed on this page are conclusive evidence of the superior efficiency of the Mazda A.C./S.G. and prove that you will get greater amplification and greater stability than with any other screen grid valve.

The Amazing

MAZDA

ALL-MAINS VALVES



THE EDISON SWAN ELECTRIC CO., LTD.,
 Radio Division,
 1a, Newman Street, Oxford Street, W.1.
 Branches in all the Principal Towns.

EDISWAN

V.33.

PRICE
25/-

D·C to A·C

If your supply mains are D.C. you can operate an A.C. All-Electric Receiver by using the



**D. C. to A. C.
ROTARY
TRANSFORMER**

Can be supplied to run from any voltage 12-250 V.D.C. 40 watt model £13; 85 watt model £19. Recommended and used by Philips Radio, Marconiphone, Burndept, Kolster-Brandes, M.P.A., Etc., Etc.

Write for Pamphlet 596/1 which gives full details.

THE M-L MAGNETO SYND. LTD.,
Radio Dept., COVENTRY.

Telephone : 5001.



Goebel's

"IT'S THE TOBACCO THAT COUNTS"



*Player's
please*



PLAYER'S "MEDIUM" NAVY CUT CIGARETTES

ANOTHER new TRIX surprise!

Get introduced to the new **TRIX AMPLIFIER!** This instrument is designed to work entirely from A.C. Mains. Three stages of amplification are provided with two large power valves in the last stage. Several loud speakers can be utilized simultaneously if desired. Sheet steel case, crystalline finish. Power dissipated in output stage; approx. 20 watts. The **TRIX AMPLIFIER** is ideal for amplification of records for dance halls, cinemas, restaurants, seaside entertainments, etc. Complete with valves, fuses, switch, safety plugs, simple input and output connections.

Send for complete details and surprisingly reasonable prices.

Manufacturers :-

ERIO J. LEVER (TRIX) LTD.,
8/9, Clerkenwell Green, London, E.C.1
Phone: Clerkenwell 3014/5.

TRIX BRITISH MADE AMPLIFIER



Mention of "The Wireless World," when writing to advertisers, will ensure prompt attention.

Power Grid Detection

The Principles of the Distortionless Grid Rectifier.

By
W. T. COCKING.

IT is usually more difficult to prevent distortion in the detector and its associated circuits than in any other part of a receiver. The special form of the diode rectifier, known as the "Kirkifier," gives the greatest freedom from distortion, but it is so inefficient that, probably, it will never be of much general use.

Of the two common methods of rectification,¹ anode bend has the reputation of giving better quality than the grid detector. The latter is usually considered hopeless for use in a high-quality receiver, but the bad quality which is generally obtained with it is entirely due to the use of unsuitable values for the components and unsuitable voltages. Properly used it is capable of giving far better quality than the anode rectifier, while it is about twice as sensitive; the quality, indeed, is but little short of that with the diode.

Two kinds of distortion can occur in the grid detector, frequency distortion, and amplitude distortion, and each can occur in both the grid and anode circuits. Frequency distortion in the anode circuit is well known and need not be considered here; it can be eliminated, for all practical purposes, by the use of suitable inter-valve coupling components.

Frequency distortion in the grid circuit depends upon the relative values of the grid leak and condenser, and it can be reduced to a negligible amount by the choice of suitable values for these. Amplitude distortion is by far the more serious, and is more difficult to eliminate; the amount of such distortion in a rectifier of any kind depends upon the degree of modulation of the high-frequency input voltage which is to be rectified, and it increases with an increase in the depth of modulation.

The action of the grid detector is somewhat more complex than that of the anode bend rectifier; but it is essential that the broad principles of its operation should

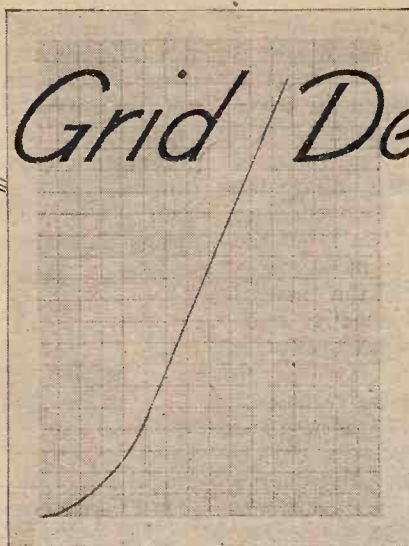

be understood before a choice of its operating conditions can be made. With a grid detector, rectification takes place on the curvature of the grid-volts grid-current curve, and this is shown for a Mazda AC/HL valve in Fig. 1. As with all valves of

the indirectly heated cathode type, grid current flows even when the grid is at a potential negative with respect to the cathode; in practice, this is very convenient, since the grid leak may be returned directly to the cathode without any necessity for biasing potentials. Although a valve of this type is used for the purposes of illustration in this article, the conclusions reached are equally applicable to ordinary battery-type valves, but with these it is usually necessary to connect the lower end of the grid leak to a source of positive potential.

Finding the Operating Point.

The rectifying action is the same as that with a diode; indeed, for rectifying purposes the grid and cathode of a grid detector may be considered as the anode and cathode of a two-electrode valve. The operating point of the valve is determined by the resistance of the grid leak and the potential of its lower end. In the case of indirectly heated A.C.

valves it is convenient to connect the leak directly to the cathode, and the operating point is then determined by the resistance of the leak. This operating potential can be found by drawing a straight line across the grid-volts grid-current curve from the point on the voltage scale corresponding to the potential of the lower end of the leak, to a point on the vertical grid-current scale corresponding to the current which would flow through the grid leak if the voltage difference between the first point and that at the point where the current and voltage axes join were applied to it. The slope of this line is inversely proportional to the resistance of the leak. This is illustrated in Fig. 1, where the points P, Q and S, at the intersections of the lines AD, BD, CD, drawn as described above for grid leaks of 0.15, 0.25 and 2 megohms respectively, give the voltages on the grid when no signal is applied.

WHILST great strides have been made during the last two years in methods of valve amplification at high and low frequencies, there appears to have been little advance in the processes involved in detection. In this article the linear properties of a new form of grid detector are discussed and should be of particular interest at a time when the percentage modulation of broadcast transmissions is continually increasing.

¹ Further information on rectification in general, and on the high input grid detector in particular, will be found in a series of articles by Professor Terman, of Stanford University, U.S.A., published in *Radio Broadcast* for March, 1929, seq.

Power Grid Detection.—

When a high-frequency voltage is applied to the grid it fluctuates about the operating point, and it swings in equal amounts positive and negative with respect to this point. Since the valve is operated upon the curve portion of its characteristic, the fluctuations of grid current on each side of the normal steady grid current are unequal. In each cycle of the applied voltage the positive half causes a larger change of grid current than the negative half. Indeed, if the input is large the change of grid current during the negative half-cycle is negligible; while if the input is very small the changes in grid current during the positive and negative half-cycles are so nearly equal that there is practically no rectification.

This flow of grid current during the positive half of each cycle charges the grid condenser to a negative potential, and during the negative half-cycle the charge leaks away through the grid leak. The negative charge on the condenser, however, reduces the anode current, thus giving rise to voltage variations across the anode-circuit load impedance. In the case when both the grid-volts grid-current and grid-volts anode-current curves are straight, the charge on the grid condenser, due to the rectification of the applied H.F. voltage, is exactly proportional to that voltage, and the change

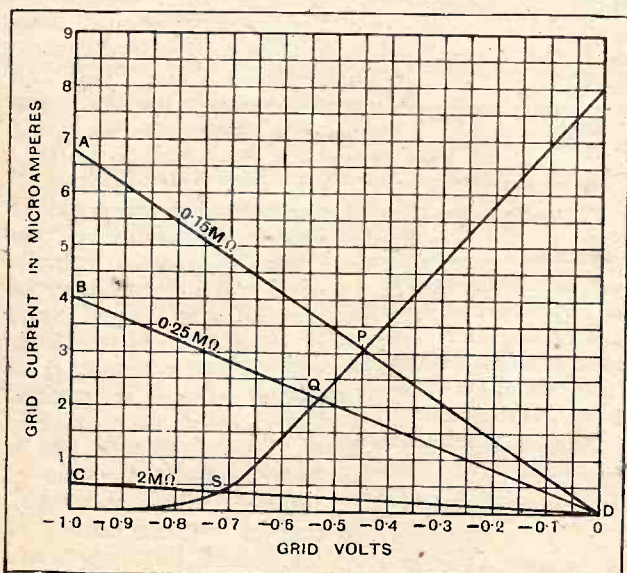

Fig. 1.—Grid-current curve of an AC/HL valve showing operating points for three values of grid leak. Note the straightness of the characteristic.

in anode current is also proportional to the charge on the condenser. This means that the change in anode current is directly proportional to the applied H.F. voltage, and the whole action of the valve is completely free from distortion; in other words, the detector is linear. In practice, however, the valve curves are straight over a portion of their length only, and the problem of obtaining freedom from distortion becomes one of ensuring that the applied voltages are always impressed upon these straight portions of the curves. From the foregoing it will be seen that the grid

detector really consists of a diode rectifier followed by a low-frequency amplifier; and, to a large extent, the two different actions can be considered separately. The usual detector circuit is shown in Fig. 2 (a), and in Fig. 2 (b) we have the equivalent circuit to illustrate this separate rectifying and amplifying action. From the grid-current curves of the AC/HL valve (Fig. 1) it can be seen that for all grid potentials more positive than -0.65 volts the curve is a straight line. This means that when the H.F. voltage is large enough to

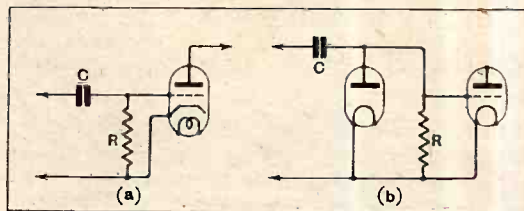

Fig. 2.—The conventional connections of a grid detector are shown at (a). The process of rectification is better understood by examining diagram (b) where a diode is shown followed by a triode amplifier.

ensure that the peaks always fall within this straight-line region, the grid current, and hence the charge on the condenser, is proportional to the input; that is, the rectification is distortionless. Now, a modulated high-frequency voltage can be thought of as a pure H.F. voltage of the carrier frequency varying in amplitude at the modulation frequency. It is obvious, therefore, that rectification will be distortionless only if the peaks come on to the straight portion of the characteristic, when the H.F. amplitude is at its smallest, corresponding to deep modulation. When modulation is 100 per cent., or when it approaches this figure, distortion must always occur; for with 100 per cent. modulation the H.F. amplitude varies between double the normal unmodulated amplitude and zero. It will be seen, however, that the larger the input voltages the smaller can be the instantaneous voltage with deep modulation in comparison with the normal unmodulated voltage; or in other words, the deeper can be the modulation without distortion.

Power Grid Detector requires Large Inputs.

It would appear, then, that to prevent amplitude distortion in the grid circuit it is only necessary to apply an input voltage of sufficient magnitude to ensure that, with the maximum depth of modulation ever used, the instantaneous peak voltages are never low enough to enter the curved portion of the characteristic. The requirement, therefore, is exactly the same as that for anode rectification, and the reason why grid detection is the better is that the curved portion of the grid-current curve is much shorter in comparison with the total available length of characteristic than is the case with the anode-current curve.

Now, it is well known that if an attempt is made to obtain a large output from the grid rectifier, the reproduction immediately becomes very distorted. With any normal input (say, 3 volts peak) there is nothing whatever in the grid circuit to cause distortion, for the grid-current curve is perfectly straight up to quite large

Power Grid Detection.—

amplitudes. It would seem, therefore, that the distortion must occur in the anode circuit, and an inspection of the grid-volts anode-current curves for the usual actual H.T. voltage of 50 to 70 reveals that this is the case. The distortion usually associated with the grid detector when an attempt is made to obtain a large output is entirely due to the use of a low anode voltage. This is evident when it is remembered that, in addition to the rectifying action between the grid and cathode, there is an amplifying action between the grid and anode circuit.

When a high-frequency voltage is modulated 100 per cent. the instantaneous peak voltages vary between zero and twice the normal unmodulated amplitude. The valve must, therefore, be able to amplify without distortion a voltage of twice the unmodulated carrier amplitude. This means that the grid-volts anode-current curve must be straight for voltages negative with respect to the cathode up to twice the carrier amplitude. If in any given case the undistorted output is too small, it can nearly always be increased by increasing the H.T. voltage. When the usual H.T. voltage of 60 is

high permeability cores, but it is just within the rating of transformers such as the Ferranti AF5. The writer has used one of these transformers with this current through the primary with a Mullard 354V. valve (this has characteristics almost identical with those of the AC/HL) as a grid detector, feeding a power stage consisting of two P.625 valves in push-pull. The power stage required an input of 48 volts peak; therefore, the maximum voltage required across the transformer primary was $48/3.5=13.7$ volts. Either the AC/HL or the 354V. valve will easily deliver this with 100 volts H.T., and the combination proved very satisfactory in practice. It was noted, however, that on very loud passages in music there was a certain amount of distortion. It was not due to overloading the power stage, for the milliammeter needle remained perfectly steady. It was found that it was due to the H.F. input to the detector being small enough with deep modulation to come on to the curved portion of the grid-current curve. Although the quality was much better than that usually obtained with the anode rectifier, the distortion was of the same character and quite noticeable with a loud speaker shown previously to have good characteristics.

From what has been said earlier, it can be seen that the only cure for distortion of this kind is an increase in the H.F. input. This immediately leads to difficulties, if the same method of inter-valve coupling be used. A larger input to the same valve naturally results in overloading the power stage; the use of a valve with a lower amplification factor would overcome this difficulty, but such valves invariably have a lower anode resistance, and therefore pass a larger anode current. The H.T. voltage cannot be reduced or distortion will occur in the anode circuit of the rectifier; and with the same H.T. the anode current would be too great for most transformers.

The solution is to feed the transformer through a resistance and condenser, as in Fig. 3, which shows the detector and power stage, together with the H.T. smoothing arrangements, of an experimental receiver built to try out the linear grid detector. Since the detector amplification is lowered by this method of connection, the same valve can be used, and a larger H.F. input applied without overloading the power stage. It is, however, necessary to increase the H.T. voltage, owing to the loss of volts in the anode resistance.

An anode resistance of 20,000 ohms, the AF5c transformer being fed through a 1 mfd. condenser, has been found very satisfactory when an H.T. voltage of about 300 is used. This gives a steady anode current of 8 mA.; consequently, the actual voltage on the valve is only about 140 volts, so there should be little danger of a reduction in valve life.

In Fig. 4 are given two curves showing the charac-

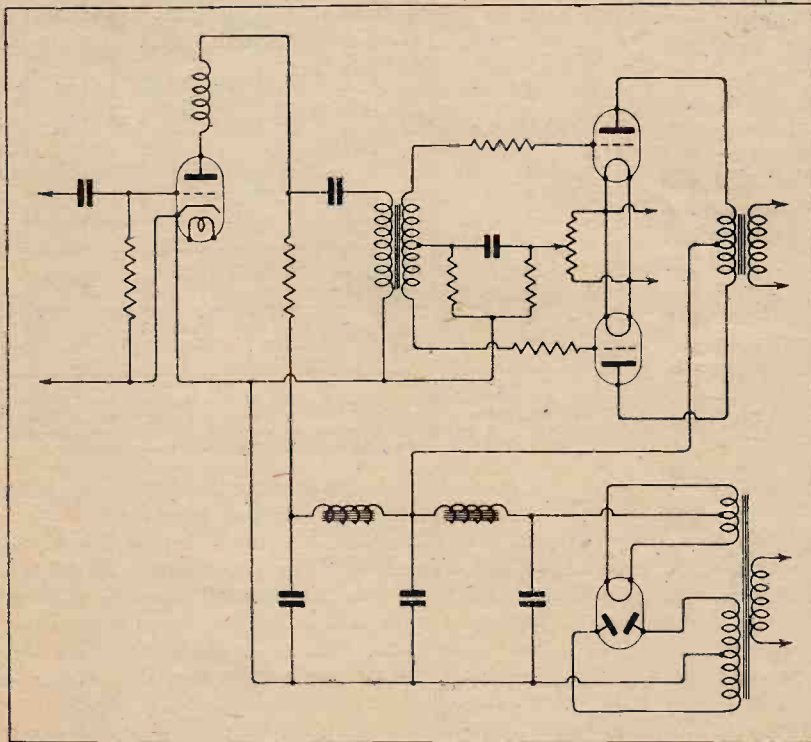

Fig. 3.—Suggested circuit for a power grid detector directly followed by push-pull output.

used with the AC/HL valve distortion will occur if the H.F. input is greater than about 0.25 volt peak; but with 100 volts H.T. the input can be about 1 volt before distortion becomes evident.

High-anode Voltage Required.

With 100 volts H.T. the steady anode current is about 5 mA.; this is too high for most transformers with

Power Grid Detection.—

teristics of the AC/HL valve with an H.T. voltage of 300 and an anode-circuit load resistance of 20,000 ohms; curve No. 1 is with a grid leak of 0.25 megohms, and curve No. 2 with 0.15 megohms. It should be noted that three scales are provided: A, showing the L.F. voltage applied to the grid by the rectification of a 100 per cent. modulated signal; B, the change in anode current recorded by a milliammeter; and C, the L.F. peak voltage developed across the anode resistance for 100 per cent. modulation. The figures for other modulation depths can easily be obtained from these by multiplying them by the depth of modulation, expressed as a percentage, and dividing by 100. It will be seen that the curves are practically straight for input voltages between 0.75 volts and 7 volts, and therefore the input voltage should always lie between these values. The maximum input with 100 per cent. modulation, therefore, is 3.5 volts peak, and the anode-circuit distortion with this input is under 4 per cent. This is not serious, since the grid circuit with this modulation depth introduces considerably more distortion; and when the modulation is less deep, and distortion in the grid circuit is negligible, the anode-circuit distortion is also much less.

An H.F. input of 3.5 volts can be considered the maximum allowable for distortionless reproduction, and it is, therefore, the optimum input for this valve. An L.F. peak voltage of 25 is produced across the anode resistance with 100 per cent. modulation, and if a 3.5:1 ratio transformer be used, the secondary voltage will be 87.5 peak volts. Such a large voltage necessitates an output valve of the LS6a type with a grid bias of 93 volts. The modulation depth, however, is rarely as great as 100 per cent., and in most cases an output stage able to handle a peak voltage of 80 would be satisfactory; this could be economically arranged by using two P650 valves in push-pull. If an output of only 1 watt is considered sufficient, a single P625 valve resistance-coupled to the detector would give very good results.

Tackling Frequency Distortion.

With this input voltage of 3.5 peak the rectification is quite distortionless for modulation depths up to 80 per cent. The use of a lower resistance valve, such as the Mullard 164V., with the same H.T. voltage would allow a larger input voltage to be applied to give the same output, thus giving freedom from distortion on more deeply modulated signals. The usual power stage, however, is often overloaded on loud passages in music, and when this is the case there is little advantage to be gained by eliminating distortion in the rectifier. Usually it is unnecessary to trouble about modulation depths greater than 80 per cent.

The Mazda AC/HL and the Mullard 354V. valves are almost identical, and will give equally good results when used under the same conditions. The circuit of Fig. 3 with a valve of this type as the detector gives extremely good results; judged aurally, which is, after all, the ultimate test for a broadcast receiver, there appears to be no amplitude distortion on the London transmitter with the maximum depth of modulation

yet heard. The quality is far superior to that with the anode rectifier, and on a normal transmission is as good as that with a diode.

It will be obvious from what has been said that the grid detector is capable of giving a low-frequency output remarkably free from amplitude distortion, and in this respect it is superior to any known method except the diode. The question of frequency distortion, however, has yet to be considered. This can occur in both the grid and anode circuits, and that in the grid circuit is generally the more serious. Frequency distortion in the anode circuit is governed by exactly the same rules as those of an ordinary amplifier, with the exception that as a condenser must be connected between the anode and cathode the choice of coupling components must be made with rather greater care. If, however, a coupling resistance of 20,000

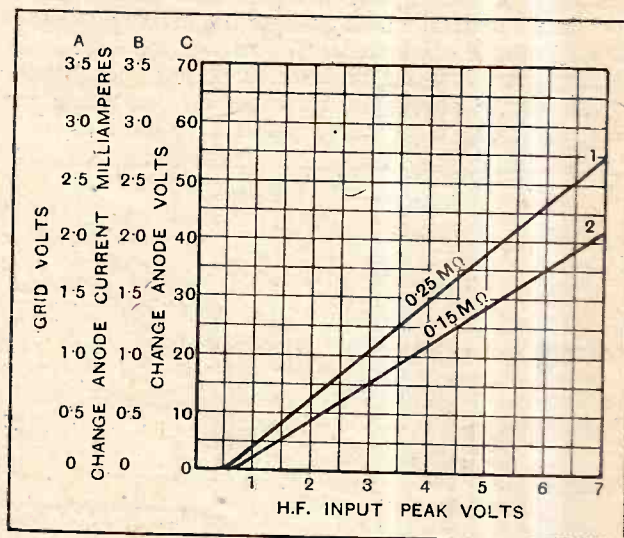

Fig. 4.—Rectification output curves of an AC/HL valve. The measurements were taken with a total H.T. voltage of 300 applied to a 20,000-ohm coupling resistance. Distortionless output can be obtained for comparatively large inputs.

ohms be used the condenser may have a larger value than is customary, without a loss of high notes.

Frequency distortion in the grid circuit is due to the grid leak and condenser. The conditions with a large input are somewhat different from those with a small input, but even with the latter the usual values are quite unsuitable, and with a large input they are utterly useless. The requirement is that the charge on the condenser must be able to leak away through the grid leak rather faster than the amplitude of the modulation is changing. The frequency at which the charge leaks away at the same rate as the modulation amplitude is changing is given by

$$f = \frac{1}{2\pi RC}$$

where f = modulation frequency.

R = resistance in ohms of the grid leak.

C = capacity in farads of the grid condenser in parallel with the effective grid-filament capacity of the valve.

A capacity of about 0.0001 mfd. is usually the best,

Power Grid Detection.—

from all points of view, and if the grid-filament capacity of the valve is 30 mmfd. the total capacity is 1.3×10^{-10} farads. With this capacity the grid leak must not be

$$\text{greater than } R = \frac{1}{6.28 \times 5 \times 10^{-7}} = \frac{10^8}{3.14} = 0.3184 \times 10^6 =$$

0.32 megohm if high notes up to 5,000 cycles are to be properly reproduced. A somewhat lower value than the calculated should always be used, and in practice one would use a leak of 0.25 megohm, since this is the nearest standard value of lower resistance than the calculated. If it is desired to retain high notes up to 10,000 cycles the grid leak must not be greater than 0.15 megohm, and preferably less. The writer has used both these values with good results; the 0.25-megohm leak is perfectly satisfactory for all ordinary purposes, but a 0.15-megohm leak gives better reproduction of the high notes. The difference, however, can only be detected when the whole receiver is specially designed to give no attenuation of these very high frequencies, and the loud speaker is exceptionally good. With the average receiver and loud speaker no difference in quality can be detected when using a leak of lower resistance than 0.25 megohm. As will be seen from the curves of Fig. 4, the sensitivity with the lower value of grid leak is reduced; the rectification efficiency is less, although there is no more amplitude distortion. On this question of amplitude distortion there is little to choose between the two values of grid leak, and the choice made depends upon the extent to which a sacrifice of signal strength for a reduction of frequency distortion is justified in any particular case.

The greatest disadvantage of the grid detector is the load which it imposes upon its tuned-grid circuit. The AC/HL, when working as a linear grid detector, has a grid A.C. resistance of about 80,000 ohms, but the load imposed on the tuned circuit is not quite so heavy, since the grid condenser is in series with it. To a small extent the use of a small grid condenser reduces the load imposed by the valve, but the best method

of reducing it is to connect the grid condenser to a tapping on the coil. The damping with a grid leak of 0.15 megohm is greater than that with a leak of 0.25 megohm, giving both lower selectivity and efficiency.

Motor-boating.

The use of a high anode voltage on the detector creates a difficulty in eliminating feed-back from the power stage, since the usual decoupling resistance cannot be used, owing to the loss of voltage which it would cause. The parallel-feed circuit is less prone to feed-back than the usual circuits, but in spite of this it is advisable to include a measure of decoupling. The connections of the smoothing circuit in Fig. 3 should, therefore, be noted. The two chokes are in series, and the H.T. tapping for the power stage is taken from the junction between them. A choke of 15H. inductance provides sufficient smoothing for the power stage, while the use of a 50H. choke in series with it for the detector stage completely eliminates hum; in addition, the detector smoothing choke acts as a decoupling component. The inductances quoted above are actual figures with the normal steady anode current flowing through the chokes.

In conclusion, it may be said that the linear grid detector is capable of providing much better quality than the anode detector; the former requires an input voltage of 2.5 to 3.5 volts peak for the best results, while the anode rectifier, for minimum amplitude distortion, needs an input of about 10 volts. It will thus be seen that a more sensitive receiver is possible. The grid detector requires a smaller input, and it is about twice as sensitive as the anode bend when both have the same input voltage. Apart from the rather high anode current which must be used its only disadvantage would appear to be the heavy damping which it imposes on its tuned-grid circuit. Nevertheless, it is the writer's opinion that its use is justified even in powerful long-distance receivers, for the loss of selectivity which it occasions can always be remedied by the inclusion of an extra tuned circuit.

TUNING A WAVE-TRAP.

FOR the elimination of a powerful local station in favour of a more distant transmitter a wave-trap is perhaps the most commonly used aid. It is especially popular because the addition of a wave-trap does not entail any alteration to the receiver itself.

There is one small point connected with the tuning of a wave-trap which is not so generally known as it might be, while if this point is overlooked a perfectly satisfactory wave-trap may, quite unjustly, be voted a failure. In order to attain complete elimination of the local transmitter, it is necessary for the trap to be coupled quite closely to the aerial circuit of the set. This implies that the two do not tune quite independently, so that the tuning of the trap is upset slightly when the receiver is retuned.

If, then, the local station is tuned in at full strength,

and the trap is then tuned so as to cut out the signals completely, the retuning of the set to find another station will usually upset the wave-trap adjustment sufficiently to enable the local station to be heard again. Thus the trap may unjustly be condemned as useless.

The receiver, equipped for preference with telephones rather than a loud speaker, should first be tuned to a wavelength some fifty metres away from the local station, which, in telephones at least, will still be audible with any set to which a wave-trap is likely to be applied. The trap is then tuned, with micrometer accuracy, to eliminate completely the residue of these signals. Adjusted in this way it will be found that the local station does not obtrude until the receiver is tuned almost exactly to it, and the wave-trap will probably be voted a huge success.

A. L. M. S.

Events of the Week

CURRENT
TOPICS

In Brief Review

OLD "SPARKS" UNITE.

Ex-members of the Signals and Wireless Section of the Royal Naval Volunteer Reserve have decided to form a permanent association.

o o o o

RADIO AT PARIS FAIR.

Wireless will occupy a prominent section of the Foire de Paris, which opens on May 17th. Nine saloons will be devoted to electrical devices and radio sets, while a special music pavilion will be set apart for radio-gramophone demonstrations.

o o o o

DEATH OF AMERICAN ANNOUNCER.

The death is reported of William S. Lynch, one of the best known announcers of the American National Broadcasting Company. Mr. Lynch, who was only twenty-three, began his career at the microphone at the age of seventeen.

o o o o

CRYSTAL USERS' PARADISE.

"A land fit for crystal users" is the slogan of the Polish broadcasting authorities, who are determined that no spot in Poland shall be outside the crystal service area of a broadcasting station. New stations are to be erected at Gydnia, near Danzig, and Lemberg.

Another reported project is the construction of a super-transmitter at Warsaw with a crystal range of 250 miles!

o o o o

PUTTING "PEP" INTO INDIAN BROADCASTING.

Indian wireless circles are now eagerly awaiting the names of the members constituting the Advisory Committee which the Government proposes to set up to control the destinies of Indian broadcasting. Pending the appointments the service is being continued on the same lines as before, but it is expected that some startling innovation in the near future will give the service a much-needed impetus towards general popularity.

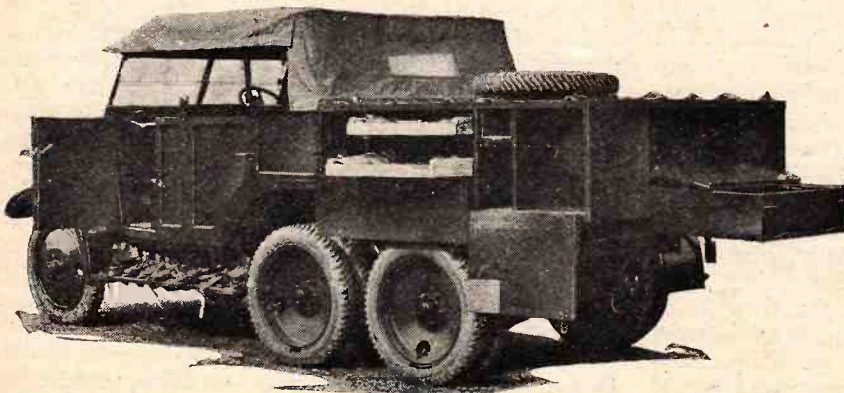

TRANSPORTABLE WIRELESS. One of the new Crossley six-wheel tenders built for the Canadian Government wireless services. The lockers are specially designed for carrying spare valves and other fragile apparatus, besides a transmitter and receiver.

NO WAITING.

"Seven seconds by the customer's watch! That's how fast programmes come in when — Tubes are used," runs the advertisement of a New Jersey manufacturer of "quick-acting" valves.

o o o o

THE BOOT ON THE OTHER FOOT.

French Government subsidies to broadcasting concerns during 1929 amounted to £700, a sum which a Paris journal regards as "indescribably ridiculous." Are French listeners aware that British broadcasting subsidises the State?

o o o o

CHURCH CHIMES BY LOUD SPEAKER.

A moving-coil loud speaker in the church tower is to be the next novelty in Tintagel, Cornwall. The bells of Tintagel have not rung for thirty years, the cost of rehanging having proved prohibitive, but the difficulty is now to be overcome by reproducing church bell gramophone records by means of a pick-up. Tintagel Church already possesses a radio-gramophone.

o o o o

RESEARCH SCHOLARSHIPS IN TECHNOLOGY.

The Manchester Municipal College of Technology offer a limited number of research scholarships in technology, not exceeding £100, tenable during the session 1930-31 at the college. Among the subjects which may be undertaken are mechanical and electrical engineering.

Full particulars are obtainable on written application to the Registrar of the College.

FRENCH TRANSMITTERS IN CONFERENCE.

The Congress of the Réseau des Emetteurs Français is to be held in Paris from May 30th to June 1st. The secretary is M. Larcher, Boite Postale II, Boulogne-Billancourt (Seine).

o o o o

COPYRIGHT IN BROADCAST NEWS.

Broadcast news is not copyright in Germany, according to an important decision of the Leipzig Supreme Court. The ruling was given after an appeal from the Lower Court by the German broadcasting authorities, who claimed that a newspaper proprietor had infringed their copyright in reprinting the broadcast account of the Graf Zeppelin's landing at New Jersey.

o o o o

AN OLD FRIEND?

Recently the Italian Press credited a lady research worker with the invention of a valve in which a broken filament could be replaced without difficulty. The inventor is now stated to be an Italian engineer, presumably of the male sex. His "special lamp" allows the filament to be changed as "easily as a broken boot lace."

We seem to know this worker. Did he not invent a matchbox wireless receiver in 1910 and a pocket transmitter in 1905?

o o o o

A TALE OF A MICROPHONE.

A strange story comes from Hobeleschwert, Silesia. Certain pupils in the high school there, being desirous to overhear the deliberations of their teachers concerning the Easter examinations, installed a microphone in a disused stove in the teachers' conference room, with a wire taken through the chimney to an amplifier. By an unfortunate coincidence the central heating system went wrong at the critical moment and the stove was set going, with disastrous results. The microphone was discovered and the students were expelled.

o o o o

TELEPHONING "DOWN UNDER."

The telephone service to Australia which was opened by the Prime Minister on Wednesday last is available at the following hours (B.S.T.): 7 a.m. to 10.30 a.m. and 4.30 p.m. to 10 p.m. on Monday to Friday, and 7 a.m. to 10.30 a.m. on Saturday. The charge for a call from any place in Great Britain to Melbourne or Sydney is £2 per minute, with a minimum of £6 for three minutes, and calls can be booked at any time. Subscribers ask their local operator for "Australian Service."

It is expected that the service will shortly be available to other parts of Australia.

o o o o

THE EFFECTS OF OSCILLATION.

A certain amount of sympathy seems due to Joseph Dawes, of Ardwick-le-Street, who was charged at the Doncaster Police Court with damaging the

wireless aerial of his neighbour. Dawes admitted having chopped down the aerial pole next door after his neighbour had persistently oscillated for two hours. The case was dismissed on condition that the defendant paid 9s. costs and made good the damage.

o o o o

THE PIRATE WITH A PORTABLE.

The owner of a portable set has been fined at Bristol for not possessing a wireless licence. It is stated that he is Bristol's first "portable pirate."

Addressing the magistrates, Mr. T. Palmer, supervisor of the Bristol Post Office, said: "You will appreciate that it is more difficult to discover these illicit stations, as there is no outside evidence such as an aerial; but the Post Office is perfecting its methods of detection, and these are pretty effective."

o o o o

LOUD SPEAKERS AND "THE OPEN WINDOW SEASON."

Stringent rules against the objectionable use of loud speakers have been passed by the New York Board of Health, writes a correspondent. A new section in the Sanitary Code reads as follows:—

"No person owning, occupying, or having charge of any building or pre-

mises or any part thereof in the city of New York shall cause, suffer, or allow any loud, excessive or unusual noise in the operation or use of any radio, phonograph, or other mechanical or electrical sound-making or reproducing device, instrument, or machine, which loud, excessive or unusual noise shall disturb the comfort, quiet, or repose of persons therein or in the vicinity."

Commenting on this regulation, a Board of Health official declared that it will give relief to thousands of city dwellers, coming into effect as it does shortly before the open-window season. More than 13 per cent. of the complaints received by the Noise Abatement Commission have been against loud speakers in shops and houses.

o o o o

ELECTRICITY SUPPLY AND BATTERY ELIMINATORS.

Readers in districts in which the electricity supply is of recent origin will be interested in a statement made to *The Wireless World* by a representative of the Electricity Commissioners, apropos the use of battery eliminators.

By the terms of their agreement with the Electricity Commissioners, old-established supply companies are bound to

replace or alter customers' existing apparatus when the supply system or voltage is changed, provided that the apparatus was installed prior to the company's notification of a change.

New companies, however, may be exempt from these terms, as it is now presumed that their customers are aware of the possibility of a supply change and will not, therefore, install any apparatus which may have to be altered without first obtaining the consent of the supply company.

o o o o

RUSSIAN CONCERTS FROM PARIS.

The Paris Radio-L.L. station is broadcasting a special series of transmissions on Sunday afternoons at 4.30, organised by the Russian General de Gorken.

o o o o

TRAIN WIRELESS IN CANADA.

"Train-ling" is the term applied by the Canadian National Railways to a new system of wiring which permits broadcast reception to be enjoyed throughout an express train, using a single receiver. Twelve new observation cars are being equipped with the system, and will shortly take their places in the principal express trains used on the trans-Continental routes.

Transactions of the Edinburgh Society.

Few wireless organisations can compete with the Edinburgh and District Radio Society in its method of preserving a record of quarterly activities. The lectures given during the preceding half-session are regularly reprinted in the Edinburgh Journal, embracing the transactions of various scientific organisations holding their meetings at the Societies' House, 16, Royal Terrace. The radio society's transactions appear in Section III of the Journal, the current issue including lectures by Messrs. H. F. Ferguson, S. D. Forrester, Ph.D., A.I.C., Wm. D. Olyphant, B.Sc., and G. N. Fordyce.

o o o o

Television Described.

For an address given recently to the South Croydon and District Radio Society, Mr. F. E. T. Clark chose as the title "I Saw." The talk related to experiments in television reception, and the speaker was able to show members the apparatus with which he had carried out tests. Unfortunately a demonstration was not possible in the absence of a transmission from Brookmans Park.

Hon. Secretary, Mr. E. L. Cumbers, 14, Campden Road, South Croydon.

o o o o

A D.C. Mains Set.

The design of a D.C. all-mains receiver was the subject of a talk given by Mr. N. B. Simmonds at a recent meeting of Slade Radio (Birmingham).

Differences in mains supply systems, smoothing difficulties, and the question of filament supply were dealt with, after which details of the circuit were given. A demonstration followed, and it was found that quite ample volume was available although only detector and pentode were used. A point of interest was that although the set was specially designed for D.C. mains the supply was taken from A.C. This required a special rectifier and smoothing device, which, however, worked quite satisfactorily.

Anyone interested may obtain particulars of the Society from the Hon. Secretary, 110, Hillaries Road, Gravelly Hill, Birmingham.

o o o o

Good Results with Three Valves.

"A Modern A.C. Receiver" was the subject of a lecture-demonstration by Mr. T. R. Tagent at the last meeting of the North Middlesex Radio Society.

The demonstration was very successful, and proved that a three-valve receiver, properly de-

signed and carefully constructed, is capable of giving extraordinarily good results.

Mr. Tagent's set is entirely self-contained, including an eliminator making use of full-wave valve rectification. Two volume controls are incorporated in the set, one predetector and one consisting of a variable resistance across the primary of the L.F. transformer. The tuning circuits were fully described, showing how selectivity of a high order could be obtained without the sacrifice of "side bands."

At the end of the meeting the Secretary announced that arrangements had been made for

NEWS FROM THE CLUBS.

FORTHCOMING EVENTS.

WEDNESDAY, MAY 7th.

Institution of Electrical Engineers (Wireless Section). At 6 p.m. At the Institution, Savoy Place, W.C.2. The following paper will be read and discussed: "A Wireless Broadcasting Transmitting Station for Dual Programme Service," by Messrs. P. P. Eckersley and N. Ashbridge, B.Sc. *North Middlesex Radio Society.* At 8 p.m. At St. Paul's Institute, N.21. Lecture: "Pick-ups and Amplifiers," by Mr. F. Youle, B.Sc. (of the Marconiphone Co., Ltd.). *Muswell Hill and District Radio Society.* At 8 p.m. At Tollington School, Tetherdown, N.10. Sale and exchange of members' transmitting and receiving apparatus.

THURSDAY, MAY 8th.

Slade Radio (Birmingham). At the Parochial Hall, Broomfield, Erdington. Lecture-demonstration: "A Four-valve Receiver with Pick-up," by Mr. R. Heaton.

FRIDAY, MAY 9th.

Radio Experimental Society of Manchester. At 8, Water Street, Manchester. Lecture: "Radio Maths," by Mr. R. M. Kay, B.Sc. (Tech.).

members to visit a "talkie" installation in the near future.

Hon. Secretary, Mr. E. H. Laister, "Windflowers," Church Hill, N.21.

o o o o

Getting Down to Essentials.

There are many radio enthusiasts, who, though keenly interested in their hobby, yet feel that their technical knowledge of the fundamentals of wireless is not quite as great as it might be. It is with the object of assisting this section of the radio public in the Muswell Hill district that Mr. L. Hartley, B.Sc., A.I.C., has prepared some interesting lectures on basic subjects, the first of which, entitled "Some of the Elementary Principles of Electricity," was given at the meeting of the Muswell Hill and District Radio Society, held on April 23rd.

Mr. Hartley first described the Electronic Theory, and detailed some of the experiments of the early scientists, following on with some useful information about wave motion. Inductance, capacity and other essentials of a radio circuit next came under discussion, and the effects of spark and continuous wave transmissions on crystal and valve receivers were explained.

A highly interesting discussion followed, as was to be expected, when the veriest foundations of radio were under investigation.

Hon. Secretary, Mr. C. J. Witt, 39, Coniston Road, London, N.10.

o o o o

A Varied Debate.

A lively half-hour debate took place at a recent meeting of the Bee Radio Society, many members taking part.

The debate was led by Mr. Chas. H. Roddis, A.M.I.E.E., who chose as the subject of discussion "British and Foreign Radio Goods." An account of some radio experiences in France soon involved the speaker in a discussion with members on a variety of topics which included the following: Valve filaments; the filament emission efficiency of 6-volt valves as compared with 2-volt valves; valve prices; electric lamp manufacture and prices at home and abroad; valve progress since the introduction of the first dull emitters; British and foreign steel; the effect of climatic conditions upon certain articles manufactured here and upon the Continent; German motor car engines; pre-war magnetos; Swedish iron; import duties; the patent law; the pentode valve and the lumber trade in British Columbia!

Hon. Secretary, Mr. A. L. Odell, 171, Tranmere Road, S.W.18.

Practical

Hints & Tips

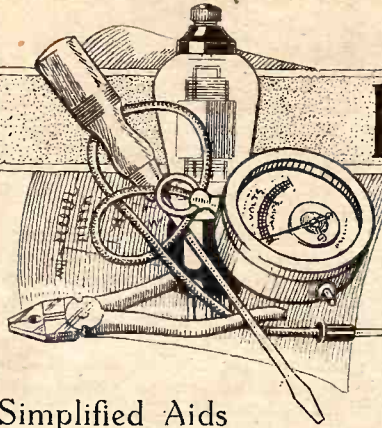
Simplified Aids
to Better Reception.

A USEFUL REMINDER.

The radio art is sadly deficient in easily remembered rules of thumb, and the few that exist are all too apt to fail if implicit reliance is placed on them.

Although lacking in strictly scientific accuracy, the statement that "wavelength is directly proportional to turns" is seldom likely to be widely misleading, and, at least, has the merit of simplicity.

This bald assertion may be elaborated: if it is known that a receiver circuit can be tuned to a certain wavelength with the help of a coil having a given number of turns, the winding necessary for receiving any other wavelength will have turns in direct proportion. It is assumed that coil diameter and other factors will remain unchanged.

When dealing with windings of conventional type, this rule is sufficiently accurate to be useful as a guide in choosing plug-in coils or even when winding inductances.

o o o o

MODIFYING A REACTION CIRCUIT.

Last week, in these notes, some of the advantages of differential reaction were touched upon, but no mention was made of the almost complete immunity from hand-capacity effects that is conferred by this particular system of control.

There is a simple explanation for this state of affairs: it is usual so to arrange the reaction coil with relation to its grid winding that full reaction is obtained without the need for completely meshing the moving vanes with the set of fixed plates that are connected to the reaction winding, and in consequence there is always a considerable capacity between the "live" rotor and the earthed section of the stator. The hand capacity of the operator will invariably be of a much lower value, and consequently its disturbing effect will be negligible.

The "single-coil Reinartz" regenerative detector circuit (Fig. 1

(a)), in which a continuation of the grid inductance acts as a reaction winding, still enjoys a measure of popularity, as applied to sets both with and without H.F. amplification. The simplicity of this arrangement is rather offset by the fact that it is a particularly bad

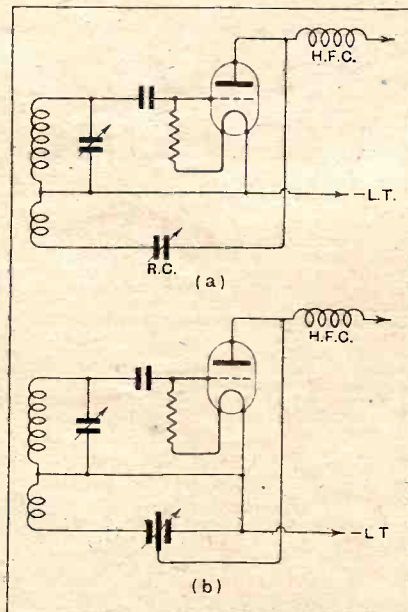

Fig. 1.—A "single-coil Reinartz" detector circuit, showing how differential reaction control may be fitted.

offender in the matter of hand-capacity effects, as both sets of control condenser vanes are "live."

Here the differential reaction condenser—an innovation since these circuits were introduced—comes to our help. One of these components can in almost every case be fitted in place of the original

control without any difficulty by following the connections given in Fig. 1 (b). The existing lead from the detector anode is joined to the condenser rotor, and the reaction coil to one of the stator's; the other stator is earthed.

To avoid the possibility of having to add turns to the reaction coil it is well to choose a differential condenser with a capacity rather larger than that of the component which it is to displace.

o o o o

REDUCING MINIMUM WAVELENGTH.

It seems that a number of frame-aerial sets cannot be properly tuned to the wavelength of the National station (261 metres). These receivers were, presumably, designed in the days when there were no important broadcasting stations operating below 300 metres.

If the frame aerial is of the simple type there is little difficulty in bringing down the lower wavelength limit of reception by taking off one or two turns. But in cases where a centre-tapped frame, probably with reaction on the "Hartley" principle, is employed, the procedure is not quite so straightforward. In this case one's aim should be to retain symmetry about the centre-point tapping, and so an equal number of turns—or an equal fraction of a turn—should be removed from each end of the winding.

A similar difficulty is sometimes encountered when dealing with a portable that is capable of reaching this low wavelength when operating with its built-in frame aerial, but is unable to do so when an outside—or even an inside—open aerial is connected in an attempt to increase signal strength when the set is working at about the limit of its range. As a rule the disturbing effect of added aerial capacity can best be offset by joining a small fixed condenser, of some 0.0001 mfd., or even 0.00005 mfd., between the lead-in wire and the aerial terminal.

Practical Hints and Tips.—

REACTION WITH ANODE-BEND DETECTION.

For reasons that need not be discussed here, it is rather unusual to make provision for reaction between plate and grid circuits of the detector when this valve functions on the anode-bend principle. Still, there are occasions where any aid to sensitivity is to be welcomed, and some advantage may be gained by making this addition to the more conventional designs.

Unfortunately, due to the small amount of power available in the anode circuit of a valve of which the grid is heavily biased negatively, well-marked reaction effects are not always obtainable. In such cases detector bias should be set with an eye to the requirements of regeneration as well as to those of detection, and a compromise should be effected by making the grid slightly less negative than is needed for best rectification.

o o o o

REWINDING "EVERYMAN" TRANSFORMERS.

The Litz wire transformer-secondary windings of "Everyman Four" receivers, and of other sets of the same family, are not particularly cheap, and so there is a natural reluctance to "scrap" them when rebuilding to a more modern circuit specification with a screen-grid high-frequency amplifying valve. If sufficient space can be allotted to these rather large coils there is no need to do so; by stripping off the neutralising coils and rewinding the primaries they can be made to suit the newer valves without very much trouble.

Dealing with the medium-wave couplings first, it may be recalled that primary and neutralising sections are interwound on grooved spacing strips. The original strips will still serve, but instead of allowing double spacing between primary turns they must be wound in adjacent grooves, thus making it possible for twice the original number to be accommodated. No. 40 double-silk covered wire is suitable for this purpose, and a total of from twenty to thirty turns will be needed, depending on valve characteristics, completeness or otherwise of screening, and on the con-

structor's views as to the best compromise between selectivity and amplification. As always, one cannot do better than work on the

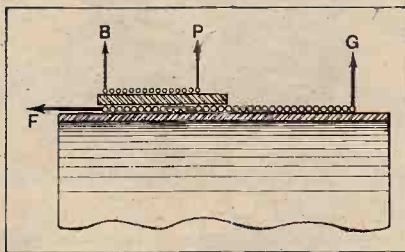

Fig. 2.—Sectional drawing showing connections of an H.F. transformer converted for operation with a screen-grid H.F. valve.

principle of trial and error, starting with a rather larger winding than it is anticipated will be needed.

The long-wave couplings for these receivers were made with superimposed primary and neutralising coils over the earthed end of the secondary. The balancing winding, with its spacing strips, will no longer be required, and the primary must be replaced by a single-layer unspaced winding with roughly 100 turns. Again No. 40

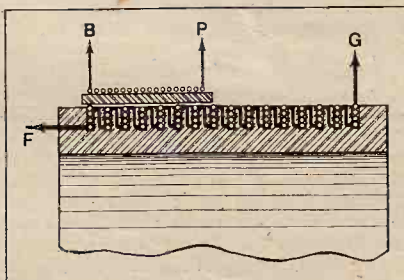

Fig. 3.—Long-wave transformer, with neutralising winding removed and primary rewound.

d.s.c. wire will be suitable, as its diameter is such that the number of turns mentioned will approximately occupy the space available.

Connections of the various ends of the coils are given in Figs. 2 and 3, which show cross-sections through medium- and long-wave transformers respectively. In these diagrams P indicates plate; B, high-tension positive feed; G, grid; F, filament.

There is no basic difference between the input circuits appropriate for neutralised triodes or for S.G. valves, and so there is no real reason why aerial-grid coils of the "Everyman Four" type—or its

variants—should not be used as they stand in conjunction with modified H.F. transformers as described. But it should be emphasised that all these coils are of rather lower resistance than those customarily inserted in screen-grid valve circuits; in order to ensure stability more than usual care must be paid to screening and decoupling. Those who are willing to take the necessary measures will be rewarded by amplification and selectivity well above the ordinary standard, in spite of the fact that their coils are converted. If it is inconvenient to observe these special precautions there remains the alternative—less attractive, but not without practical value—of reducing primary turns well below the optimum number.

o o o o

RELYING ON REACTION.

In choosing or designing a set for operation by a totally unskilled listener, one is often tempted to simplify matters by making reaction do the work that, by reason of distance from the desired transmitters, could better be carried out by an H.F. amplifier. But it is certain that a set depending entirely on reaction for its sensitivity will present greater difficulties to this sort of user than one with controls that are susceptible to fairly accurate calibration.

Every problem of this sort should be considered on its own merits. In "border line" cases, where a detector without any form of H.F. amplification (including regeneration) will give audible, albeit insufficiently strong, signals, it may be taken that reaction will provide the necessary extra intensity, and will be regarded by the user merely as a volume control. Consequently, a reacting detector set should be satisfactory enough in such circumstances.

At first sight, the same type of receiver might also seem to meet the case where a single transmission only is expected, even though its signals are so weak that full reaction is necessary. Unfortunately, it cannot be assumed that, once adjusted, the dials will call for no further attention: under these conditions, a set is extremely sensitive to quite small fluctuations in supply voltages, etc., and needs frequent touches from a moderately skilful hand.

LABORATORY TESTS ON NEW APPARATUS.

A Review of Manufacturers' Recent Products.

SCREENING BOXES.

The demand for the rectangular type of screening box used in the Foreign Listener's Four receivers and other *Wireless World* sets has given rise to increased production of this inexpensive type of collapsible box. Both the Peto Scott Co., Ltd., 77, City Road, London, E.C.1, and Messrs. Burne-Jones and Co., Ltd., Magnum House, 296, Borough High Street, London, S.E.1, are producing boxes built to the dimensions required in these receivers. In each case a wooden base is supplied for holding the box in position and carrying the components. An attractive finish is given to the aluminium in the case of the Peto Scott model by producing an engine-turned effect, while in the Magnum type a good, smooth finish, and one that will not readily tarnish, is obtained by an alkali process. These screening boxes, which are priced at 6s., are substantially built, measure 6½ in. x 6½ in. x 6 in., and have many applications in home-receiver construction.

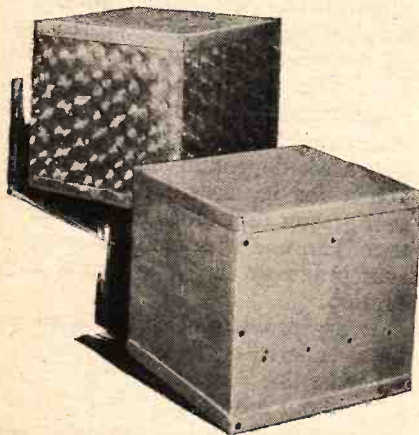

Two noteworthy examples of small screening boxes in aluminium. The Peto Scott sample is polished and engine-turned, while the "Magnum" version is dull with a frosted finish.

"PILOT QUICK ACTION" SWITCH.

This switch is intended for use in battery eliminators and mains-operated sets, its function being to control the mains supply. The action is of the quick-break or "snap" type, a desirable feature if arcing is to be prevented. It is rated to handle 3 amps. at 220 volts.

The body of the switch consists of a neat bakelite moulding which completely encloses the "live" contacts. Two terminal screws protrude from the back. A single-hole fixing bush is provided which is insulated from the "live" contacts. The sample examined was fitted with a round bakelite knob which is rotated clockwise for the "on" position, and anti-clockwise for the "off." A lever-pattern switch of the same rating is available for those preferring this type of action.

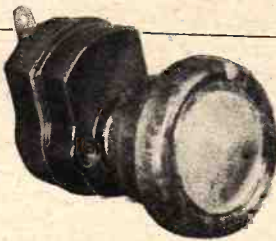
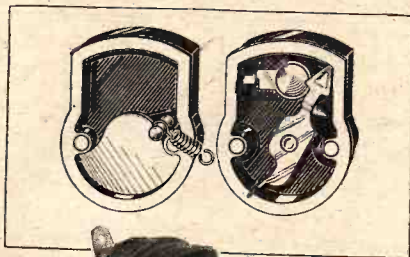

"Pilot" quick-break mains switch with knob control.

The component is of American origin and is handled in this country by Messrs. Thos. A. Rowley, Ltd., 59, Skinner Lane, Dean Street, Birmingham. The price is 2s. 6d.

o o o o

"APTUS" CENTRE FOR LINEN DIAPHRAGMS.

This useful accessory has been developed by Messrs. Moore and Co., 101, 103, Dale Street, Liverpool, to facilitate the construction of the double-cone type linen diaphragm and its attachment to the driving mechanism. The principal feature of the device is the provision of two celluloid washers which can be softened by acetone, or special "dope" supplied by this firm, and fixed to the apices of the two cones. These should be fitted before the cones are drawn together, as their function is to reinforce the centres, and thus enable them to be stretched taut without tearing the material where the holes have been made to accommodate the centre fixing device.

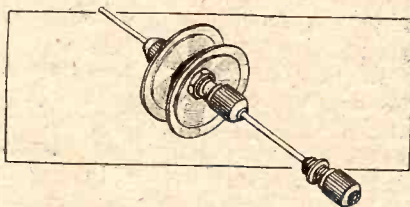

"Aptus" triple-chuck linen diaphragm centre attachment.

A small chuck is fitted either side of the cone washers; this grips an extension spindle, and on one end of this rod is another chuck for attachment to the driving spindle on the loud speaker unit. The device costs 2s. 6d. only, and should prove very useful to those interested in

the construction of the double-cone linen diaphragms.

o o o o

RED DIAMOND WAVE-TRAP SWITCH.

Recently we received from the Jewel Pen Co., Ltd., 21-22, Great Sutton Street, London, E.C.1, a sample of their model R.D.36 switch. This is a single-pole change-over pattern and is recommended by the makers for use in the "Twin Regional Rejector" described in our issue of March 12th last, in place of the model R.D.38 specified. It will be recalled that this switch was a four-spring pattern and that an external link was required connecting two of the leaves together. In the R.D.36 the two metal contact rings on the plunger are electrically connected and brought out to a single terminal. Thus by fitting this model the external cross link is unnecessary.



Red Diamond three-spring change-over switch, type R.D.36, recommended for use in the "Twin Regional Rejector" described recently in this journal.

Incidentally, a small saving in cost ensues, since the R.D.36 is priced at 1s. 6d., whereas the R.D.38 costs 2s.

o o o o

TRADE NOTES.

"Microfu" Fuses.

The Telegraph Condenser Co., Ltd., Wales Farm Road, North Acton, London, W.3, announce that they have acquired the distributing rights for "Microfu" fuses. These are cartridge-type fuses obtainable in various sizes to "blow" at any current between 10 and 1,000 milliamperes.

o o o o

Change of Address.

The Jelectro Laboratories, 179, Edgware Road, London, W.2, announce that they have acquired more commodious premises at 72, Bartholomew Close, London, E.C.1. The telephone number is National 0606. A service station for Jelectro filling and charging has been established at the new address.

o o o o

Branch Establishment.

We are informed that Messrs. Claude Lyons, Ltd., 76, Old Hall Street, Liverpool, have opened a branch office and showrooms at 40, Buckingham Gate, Westminster, London, S.W.1. The telephone number is Victoria 7595.

Broadcast Brevities

By Our Special Correspondent.

When Engineers Pay Visits.—Scottish Broadcasting Gaps.—Fewer Oscillators.

Brave Engineers.

Even a B.B.C. engineer has his human moments, and some of the letters from listeners on the subject of Brookmans Park really are aggravating. It is true that this particular correspondence is diminishing in volume, but there have been several letters of late which have driven the engineers to pay visits to the distressed homes. Sadly enough, they receive more kicks than ha'pence.

○○○○

Novices and "Experts."

The principal discovery they have made is that the utter novice is easier to handle than the man who knows the difference between an amp. and a volt. The old adage, "A little learning, etc.," holds good in wireless as in other matters.

○○○○

Criticising the Scheme.

But novice and "expert" alike are careful to tell the visiting engineer what they think of the Regional Scheme. A few damn it with faint praise, but many consider it an imposition, a device to confuse the listener and involve him in additional expense.

It is the exception to find a listener who looks at the scheme from any viewpoint but his own.

○○○○

Difficulties in Scotland.

My sympathies go out to the Scottish retailers who are complaining of an insufficiency of daytime broadcasting. Five years ago, I believe, it was possible to sell a set if it looked pretty without having too many knobs, but nowadays the prospective purchaser requires a demonstration. Yet on three days a week the Scottish stations are silent from 11 a.m. to 2.40 p.m.

What sort of economy is this that prevents the retailer from wooing new licence-holders during their hours of mid-day leisure?

○○○○

A B.B.C. Retort.

An official at Savoy Hill reminded me that Daventry-National is always available during these periods. Is this likely to satisfy the Scottish salesman? It is almost like suggesting to a London retailer that he should demonstrate his sets on Radio Paris.

○○○○

Sticking to the Right Wavelength.

By the way, Daventry-National, London Regional, Glasgow and Leeds have earned the distinction of being among

the ten best European stations, judged by their ability to maintain their allotted frequency. During a recent test month these stations were never off the track by more than 0.3 kilocycle. London National came in the 0.4 kc. category.

○○○○

Ichabod.

Amateurs have lost the chance to purchase the old 2LO masts in Oxford Street, which have now been bought by a crane contractor for less romantic purposes than wireless. They are about to be dismantled.

○○○○

Wanted: an Explanation.]

Just as a pneumatic drill startles one when it stops, so Savoy Hill is startled by a sudden decline in oscillation. This seems to be out of all proportion to the slight seasonal drop that might be expected just now.

The suggestion that the national con-

science has suddenly awakened is ruled out by the fact that pirates are as numerous as ever.

○○○○

Overcoming "Mike Fright."

Bright ideas in broadcasting technique are not so frequent that the B.B.C. can afford to neglect Philip Ridgway's brain-wave which will be put into effect when his next vaudeville programme goes on the ether on May 17th. Mr. Ridgway's idea is to overcome "mike fright" among his performers by starting off with a chorus and dance five minutes before the microphone is put into circuit.

○○○○

Those Awkward Minutes.

In this way it is hoped to tide over those first few awkward minutes when studio "nerves" are most likely to upset the performer, whether a novice or an old hand.

Dare I suggest that some of our nervous talkers would be put at ease by a preliminary song and dance?

○○○○

Broadcasting the Test Matches.

Probably even the keenest cricket enthusiast would soon tire of a running commentary on the Test Matches, cricket being one of the few games which do not lend themselves to this form of treatment, however spirited the commentator. The B.B.C. will adopt the wiser course of broadcasting an eye-witness account at the conclusion of each day's play.

These descriptions will be given from the ground between 6.30 and 6.40 p.m., the speakers being distinguished cricketers.

○○○○

Archbishop at the Microphone.

Archbishop Lord Davidson's address will be broadcast from the service at Southwark Cathedral on May 25th.

○○○○

"Safety First."

Speeches by Lord Brentford and the Lord Mayor of Liverpool will be relayed from the National Safety First Week banquet at Liverpool on May 20th to the National transmitters.

○○○○

A Broadcast Serial.

A serial story in four instalments is to be broadcast by the author, Mr. Edward Albert, from the Scottish stations, starting on May 24th and continuing on the succeeding Saturday evenings. Mr. Albert's story is called "The American Soldier."

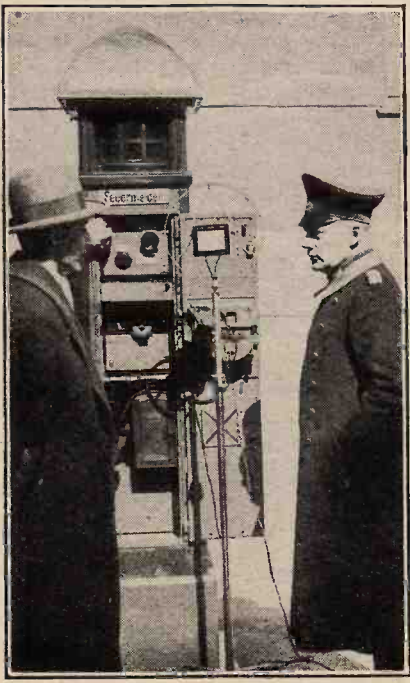

FIRE! An episode during Berlin's "Fire Brigade Week" (April 27th-May 4th), a feature of which was a broadcast running commentary on fire-fighting methods. The microphone is seen before a street alarm box.

WIRELESS THEORY SIMPLIFIED

By S. O. PEARSON,
B.Sc., A.M.I.E.E.

Part XXIX.—Inertia Effects and Time Lag in Tuned Circuits.

(Continued from page 464 of previous issue.)

HAVING given a general outline of the principles of amplitude modulation as used in radio telephony, it is now necessary to consider in closer detail the behaviour of tuned circuits in respect to modulated oscillations. The subject is one which has undergone a considerable amount of controversial discussion quite recently, and in this and succeeding parts an attempt will be made to explain the generally accepted theories as simply as the necessary elimination of mathematical treatment will allow.

The theory of an ordinary tuned circuit has been fully dealt with in previous sections as far as unmodulated waves are concerned. The resonant frequency of a circuit containing inductance and capacity is defined as that frequency for which the inductive and condensive reactances are numerically equal and cancel each other out as far as the current round the closed circuit is concerned. In a series circuit tuned to resonance, the current, *once it has reached a constant amplitude*, is given by dividing the voltage injected into the circuit by the effective series resistance. But in dealing with modulated waves the constancy of amplitude of the high-frequency oscillations no longer exists, and for this reason it will be much more helpful to consider the action of a tuned circuit from a totally different point of view.

Every resonating system, that is to say, every system which has a natural frequency of free vibration, mechanical or electrical, may be looked upon as a combination which has the property of collecting energy and storing it in an oscillating form to a maximum extent when small impulses are applied at one particular frequency.

As an illustration of this principle, let us consider, prior to dealing with the tuned electrical circuit, a simple mechanical system which has a natural frequency of vibration. An ordinary seconds pendulum will serve the purpose admirably. Suppose that a pendulum with a heavy bob takes exactly one second to swing in each direction when set in motion, so that one complete or double swing occurs every two seconds. Now if this pendulum is brought to rest it is common knowledge that it can be set in motion again by applying to it a succession of very small impulses, provided these impulses occur at a

frequency equal to the natural frequency of swing of the pendulum. For instance, if the bob is lightly touched on one side with a feather once every two seconds the pendulum will *gradually* acquire a swing, two seconds being the natural period. A definite amplitude of swing represents a definite amount of stored energy in the oscillating system, and, therefore, when the energy is given in very small pulses during the starting period the accumulation of energy and the increase of amplitude will necessarily be gradual—it is a fundamental law that a given quantity of energy can neither be accumulated nor dissipated instantaneously.

On the other hand, if the small impulses are applied at some other frequency, or at irregular intervals, the pendulum will not acquire a swing—only very slight and irregular movements will occur.

The principles illustrated here with regard to the pendulum all apply equally well to the tuned electrical circuit. The building up of oscillations in such a circuit involves the accumulation of a store of energy which oscillates backwards and forwards between the magnetic field of the coil and the electrostatic field of the condenser, as explained on page 43 of January 8th issue. Thus, when an alternating voltage of constant amplitude at the resonant frequency is suddenly injected into a closed tuned circuit, the resulting current oscillations will not immediately acquire the normal steady amplitude, but will build up gradually in a similar manner to that in which the oscillations of the pendulum build up.

For instance, suppose that the closed tuned circuit LC of Fig. 1 is tuned to the frequency of an alternator A which can be connected to a second coil L, loosely coupled to the tuned circuit, by means of the switch S. Suppose further,

that when the switch S in the alternator circuit is closed the R.M.S. value of the voltage induced into the coil L is E volts. After the switch has been closed for a considerable time the oscillating current in the tuned circuit will have a steady value of $I = \frac{E}{R}$ amperes, where R is the effective resistance, and there is a definite amount of oscillating energy in the circuit, its value being $\frac{1}{2}LI_m^2$ joules, where I_m is the amplitude of the current.

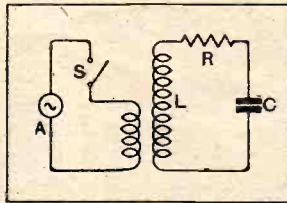

Fig. 1.—Circuit for illustrating the presence of a time lag in a tuned circuit as explained in the text.

Wireless Theory Simplified.—

The Growth of Oscillations.

Now, at the instant the switch is first closed there is no energy in the circuit, and, as explained before, it takes time to accumulate energy. So the current oscillations in the tuned circuit will start building up from zero, immediately the switch is closed, at a rate depending on the rate at which energy is given to the circuit, i.e., on the power supplied. The rate at which the amplitude of the oscillations begins to grow is directly proportional to the voltage applied to the circuit, but the circuit possesses resistance, and, therefore, as the oscillating current builds up, heat losses will occur to an increasing extent proportional to the square of the current. This means that as time elapses an increasing proportion of the power being given to the circuit will be lost in the resistance and, consequently, the rate of growth of the oscillations, which was greatest at the start, begins to fall off to a slower rate, until eventually there will come a time when the average value of the resistance losses becomes equal to the average power being given to the circuit, and the amplitude will cease to rise any farther, the normal steady condition having been reached.

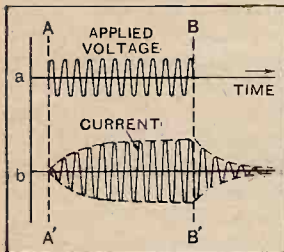

Fig. 2.—When an alternating voltage is suddenly applied to a tuned circuit the resulting current oscillations take time to build up and tend to persist when the voltage is removed again.

The principle involved can be illustrated in a crude way by imagining that we have a tall empty tank with a comparatively small pipe outlet at the bottom. If water is run into the tank from the top at a sufficiently great rate, the level of the water in the tank will begin to rise, in spite of the pressure at the outlet increases in direct proportion, so that

the rate of escape also increases. Hence, as time elapses, the rate of rise will decrease, until eventually the quantity of water escaping becomes equal to that being supplied, and the level of the water in the tank ceases to rise any farther.

Decay of Oscillations.

After the switch S of Fig. 1 has been closed for some time and the oscillations in the tuned circuit have reached a steady value, there is a definite amount of oscillating energy in the circuit, and, therefore, if the switch S is now opened again so that the applied E.M.F. is suddenly cut off, the oscillations in the tuned circuit will not cease instantaneously; the stored energy of the circuit has to be dissipated as heat in the resistance and the rate at which this occurs is proportional to the square of the current. Thus when the supply voltage is switched off the oscillations in the circuit decay at a rate depending on the rate at which the energy is converted into heat, and this is proportional to the resistance of the circuit. Thus the lower the effective resistance of the circuit the longer will the oscillations tend to persist after the voltage has been cut off.

The manner in which the oscillations build up when a constant voltage at the resonant frequency is suddenly applied, and in which they decay again when this voltage is switched off, is indicated by the curves of Fig. 2. The upper curve (a) shows the relation between the voltage induced into the tuned circuit and the time, and the lower curve (b) gives the resulting current in the tuned circuit during the same period. The switch is closed at the instant represented by the line AA', and opened at BB'.

Law of Growth and Decay.

The amplitude of the oscillations builds up and decays according to a very simple law. For instance, when the oscillations are dying out after the supply has been cut off, the ratio of the maximum values of any two consecutive half-waves is the same. Thus, in Fig. 3, which represents the last portion of Fig. 2 (b) drawn to a larger scale, the ratio $\frac{AB}{CD}$, $\frac{CD}{EF}$, $\frac{EF}{GH}$, etc., are all equal.

That is to say, the height of each half-wave is the same fraction or percentage of that of its immediate predecessor, and therefore the dotted curve drawn through the maximum points of the dying oscillation is one which is diminishing at a rate which is at every instant proportional to its height above the zero line. A curve obeying this simple law is called a logarithmic curve—it is the same contour that is used for loud speaker horns. The same law applies to the building up of the oscillation, but in this case the contour curves are reversed.

The logarithm of the ratio of the amplitude of any half-wave to that of the next one following in the same direction for a decaying oscillation is called the *decrement* of the circuit, and its numerical value is given by

$$\delta = \frac{R}{2fL}, \text{ or } \delta = \pi R \sqrt{\frac{C}{L}} \dots \dots \dots (I)$$

where R is the resistance of the circuit, f is the frequency, L the inductance in henrys, and C the capacity in farads. It is the reciprocal of this number which determines how many cycles will have to pass before the amplitude of the oscillation falls to a definite fraction of its initial value, and it is the value of this reciprocal which determines the selectivity of the circuit. In Jan. 1st issue it was shown that the selectivity of a circuit is proportional $\frac{1}{R} \sqrt{\frac{L}{C}}$. The same expression for δ can be derived from the ordinary resonance curve of the circuit.

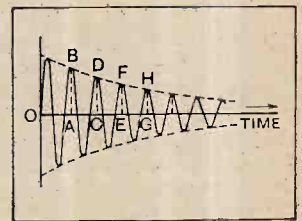

Fig. 3.—Curve illustrating the law of decay of an oscillation. The dotted contour curves are logarithmic.

Time Lag in Tuned Circuits.

The main information gleaned up to the present is that a tuned circuit possesses the property of resisting the establishment of oscillations in it, and that once the oscillations are produced they tend to persist after the source of energy has been cut off. The effect is equivalent to that of inertia in mechanics—a heavy body

Wireless Theory Simplified.—

resists the taking up of motion, but once it is set in motion it tends to continue moving even after the driving force has ceased, and a resisting force is necessary to bring it to rest again.

Not only is there a time lag in building up oscillations from zero in a tuned circuit and in reducing them to zero again, but, for the same reasons given above, a time lag will always be involved whenever an attempt is made to change the amplitude suddenly from one

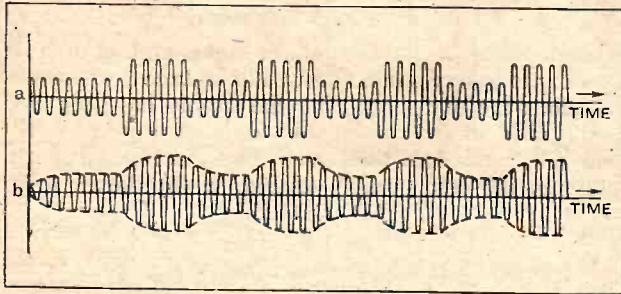

Fig. 4.—A tuned circuit has the property of resisting any change in amplitude of oscillations in it on account of the change of energy involved. Curve (a) applied voltage. Curve (b) resulting current.

value to another. Suppose, for instance, that a steady voltage at the resonant frequency has been applied to a tuned circuit for a sufficient length of time to allow the current to reach a constant amplitude, and then that this voltage is suddenly doubled for a while, then returned to its original value, doubled again, and so on as shown by the upper curve of Fig. 4. The current in the tuned circuit would then vary in the manner indicated by the lower curve, and would not accurately follow the variations of the applied voltage, because every change in amplitude brings a corresponding change in the stored energy in the circuit, and time is required to bring about this change. Reverting to the analogy of the pendulum, if a spring-wound clock is nearly run down and the swing of the pendulum is thus below the normal amplitude, the amplitude will not

build up to the full value again immediately the clock is wound up, but will take a considerable time.

Partial Loss of High Notes.

The rounding off of the contours of the current curve in Fig. 4 depends on the decrement of the circuit—the lower the decrement the more pronounced is the time lag, that is to say, the lower the resistance of the tuned circuit and the higher the ratio of inductance to capacity the more loth will be the current oscillations to follow the variations of applied voltage.

It will be clear also that if the amplitude of the applied voltage is increased and decreased at a very rapid rate, the current oscillations will have less time in which to change; and so, as the frequency of modulation is increased (for this method of varying the amplitude of the applied voltage is really a special form of modulation) the corresponding variations of current amplitude will decrease. The tuned circuit thus has the effect of attenuating or partly damping out the modulation.

The same arguments apply to the case in which the high-frequency voltage induced into the tuned circuit is modulated harmonically, i.e., in such a manner that the amplitude varies according to a simple sine law as explained in the previous instalment. It follows then that the higher the acoustic frequency of modulation, the greater will be the attenuation, and so in a sharply tuned circuit there is an inevitable loss of high notes.

The extent to which the audio-frequency component of the oscillations is weakened can be calculated for various frequencies over the audible range, but this is not at all simple if the calculations are based on the "persistency" or time-lag effects exhibited by a tuned circuit. Fortunately, however, there is very simple means of dealing with the problem from another point of view, namely, by the resolution of a modulated wave into a series of pure sine waves of high frequency, each having constant amplitude and frequency, whose sum gives the modulated wave in question—in other words, the phenomenon of sidebands.

(To be continued.)

Carrington Manufacturing Co., Ltd., Camco Works, Sanderstead Road, South Croydon.—Illustrated folder of Camco Cabinets, with loud speaker compartment for Philips 3- and 4-valve receivers.
o o o o

Igranic Electric Co., Ltd., 149, Queen Victoria Street, London, E.C.—Descriptive folder dealing with the Igranic-Pacent single-phase induction type electric gramophone motor.
o o o o

Loewe Radio Co., Ltd., 4, Fountayne Road, Tottenham, London, N.15.—Illustrated leaflet describing the Loewe moving coil loud speaker and associated equipment.
o o o o

Columbia Graphophone Co., Ltd., 92, Clerkenwell Road, London, E.C.1.—Illustrated folders describing the Columbia range of portable and table model battery- and mains-operated sets, also console cabinet type radio gramophones.

Catalogues Received.

Messrs. J. J. Eastick & Sons, "Eelex House," 118, Bunhill Row, London, E.C.1.—Illustrated folder dealing with "Eelex" terminal and connectors, also general catalogue for 1930.
o o o o

Regent Radio Supply Co., 21, Bartlett's Buildings, Holborn Circus, London, E.C.4.—Descriptive folder of Regentone combined H.T. eliminator and I.T. trickle charger.
o o o o

The Electro-Dynamic Construction Co., Ltd., 733b, Old Kent Road, London, S.E.15.—Price list and specification of D.C. to A.C. rotary transformers for operating A.C. sets from D.C. mains.
o o o o

Electradix Radios, 218, Upper Thames Street, London, E.C.4.—72-page cata-

logue of new and used Government disposal apparatus. o o o o

Lissen, Ltd., Lissenium Works, Worpole Road, Isleworth, Middlesex.—Descriptive folder of the "Lissenola" two-valve transportable set.
o o o o

Maestrophone Radio Gramophone and Wireless Co., Grammar School Lane Works, Halesowen, near Birmingham.—Illustrated brochure of the "Maestrophone" radio gramophone all-electric and battery-operated models.
o o o o

Messrs. Ward & Goldstone, Ltd., Frederick Road (Pendleton), Manchester.—Descriptive leaflet of "Goltone" "No-Mast Plate Aerial."
o o o o

The Decca Gramophone Co., Ltd., 1 and 3, Brixton Road, London, S.W.9.—Illustrated catalogue of "Decca" portable sets, all-electric radio gramophones, and electric gramophones.



THE CRYSTAL RECEIVER for TELEVISION — IS HERE?!

A Recent Development from
Germany.

INCOME TAX, we are told, is much lower in Germany than here. Possibly that is the reason for a certain buoyant lightheartedness, or shall we say optimism, which may be found in some of their wireless periodicals. Such optimism is evidenced, for instance, in an article by Herr Rhein in the popular weekly *Die Sendung*, of 28th March last, under the title:—

“TELEVISION DETECTOR.—A Televisor Without Valves or Moving Parts.”

The start-off is worthy of the title. “So the rumour which for weeks has been circulating in technical circles has come true—the television detector is here!” In picturesque language the writer describes the recent boom in cathode-ray tubes for television purposes, and the accompanying slump in the older apparatus: “In the laboratories the Nipkow disc and mirror wheel stand motionless; the journalist’s epigram, ‘The Nipkow disc has a great . . . past!’ has sped in all directions. . . .”

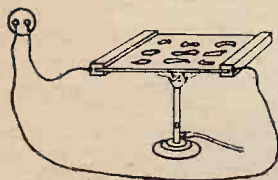

Fig. 1.

And then, just as you are beginning to expect a mere panegyric of electron beams as a mechanism for television, comes the surprise. We have come to the conclusion that the best thing to do is to give it in the author’s own words, translated, only abbreviating in places, and taking care to omit nothing important in so doing. Here goes, then:—

“And then, plumb in the middle of the mad race for success, comes the announcement that Prof. Fiesemöpp, of the Technical College at Karlsruhe, has invented a detector for television. During some electro-chemical researches he noticed that a quartz plate, ground thin and coated with silver-chloride gelatine and connected as in Fig. 1 to the D.C. town supply showed variations of brightness, in spots or streaks, when a red-flamed Bunsen burner was placed beneath it. . . . Further investigation showed that the ‘shadows’ were still more marked if the quartz was heated less highly—in fact, only to 65 degrees—and was strongly illuminated. An Osram ‘Nitra Opal’ lamp was found specially satisfactory, as it gave both the necessary

light and heat. The latter could be accurately adjusted by putting the lamp in a metal box with adjustable slots above and below (Fig. 2). The wealth of contrast decreases very markedly for a slight over- or under-heating—even 3 degrees. . . . It was found that the shadows were produced by the ripple on the town D.C. supply. [It had already been noticed, during a strike, that D.C. from accumulators produced no shadows at all.] When alternating current was applied weak but clear darkenings appeared, which increased—on raising the voltage—to such an extent that the plate appeared entirely black.”

“These experiments remained for a time undeveloped, since there seemed to be no possible practical use for the Fiesemöpp phenomenon.

The professor’s assistant, Dr. E. Dötsch, was the first to carry things farther. He connected the plate in the place of the detector in a simple receiving circuit (Fig. 3). On connecting the apparatus



Fig. 2.—“Simple experimental arrangement of the Fiesemöpp Televisor.”

to a high aerial, and tuning in to the local station, strong shadow effects became visible which were in rhythmic connection with the music given out by a separate receiver close by. Thus it was shown that the quartz plate was receptive to high-frequency oscillations and could convert them into strong light impressions.”

“In general, a technical process may be made to produce a reversed effect (e.g., motor-dynamo). With this in mind, Dr. Dötsch inserted a lantern slide between the quartz plate and the lamp, and connected the quartz plate to a small transmitter in such a way that the waves of this transmitter could be modulated, as by the alternating current from a microphone. The experiment was successful; in a receiver in the same room, the lantern-slide picture appeared clear and distinct.”

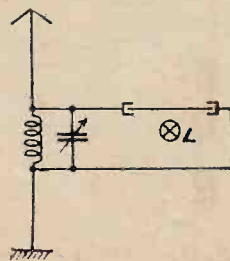

Fig. 3.—“L is the lamp providing warmth and light.”

“Dr. Dötsch called his col-

The Crystal Receiver for Television—is Here?—leagues to see the success of his endeavours. They thought it was a leg-pull, and demanded that the picture should be changed. While Dr. Dötsch was in the act of removing the first lantern slide yet another sensational thing happened: the whole process of removal was seen clearly in the receiver. Thus was the transmission of moving pictures discovered.”

Now comes rather a sudden jump to calm, quiet details. “The size of the picture in the receiver is dependent on the high-frequency voltage available. Either a high aerial, or a corresponding degree of amplification, is needed unless one is content with very small

(4 × 5 cm.) pictures. [Personally, we should be content with these, just as a start-off.] By using an ordinarily high aerial the size of the picture can be extended to 25 × 32 cm.”

“The exceptionally successful results attainable with this system has led the German Post Office to start nightly test transmissions. These are, at present, limited to the transmission of still pictures, and take place on the normal wavelength of the Witzleben transmitter between 1 and 2 a.m.” Between 1 and 2 a.m. April 1st, we presume, since this copy of *Die Sendung* is dated March 28th. We will leave it at that, and wonder how many readers of *Die Sendung* fell for it!

CORRESPONDENCE.

The Editor does not hold himself responsible for the opinions of his correspondents.

Correspondence should be addressed to the Editor, “The Wireless World,” Dorset House, Tudor Street, E.C.4, and must be accompanied by the writer's name and address.

“THE WIRELESS WORLD”—FIRST COPIES.

Sir,—I was interested to read in your paper dated 23rd inst. that Mr. E. G. Wright still has a No. 1 copy of *The Wireless World* dated April, 1913. I have been a subscriber to your very excellent paper from its inception, and have the twenty-five volumes bound and in perfect condition. I also have *The Marconigraph* for the years 1911-12 and part of 1913. This journal, as many of your readers are doubtless aware, preceded *The Wireless World* and was published monthly, price 3d. I might add that during the War my copies of *The Wireless World* were duly despatched to me overseas and I did not lose a single copy.

F. J. HUGHES.

Bath.

[Many readers have written stating that they still have their first copies, many having taken *The Wireless World* consistently from No. 1.—Ed.]

D.C. TO A.C.

Sir,—I was interested in “Enquirer's” letter in your issue of March 12th, and am still more interested in the letter of “Ohm Sweet Ohm” in *The Wireless World* of April 2nd.

“Enquirer” complains that the Edinburgh Corporation refuse to accept liability for putting a D.C. eliminator out of commission, and states: “They base their stand upon the fact that they were not informed when the high-tension eliminator was originally installed.” If “Enquirer” cares to obtain a copy of the general conditions governing the supply of electricity in Edinburgh (he can no doubt obtain a copy from the electricity offices or showrooms), I anticipate he will find a clause to the effect that no apparatus shall be connected to the Corporation's mains until application for same has been made upon the form provided for that purpose by the Corporation, and the apparatus, and wiring in connection therewith, have been examined and passed as satisfactory by the Corporation's inspector. This application form constitutes a legal agreement, and if a previous application form has been signed for lighting or other apparatus, this agreement has been broken by non-compliance with the general conditions of supply.

Having regard to the above circumstances, it would appear that the Edinburgh Corporation are perfectly justified in their refusal to accept liability for the apparatus in question. Apparently, until it was proposed to change over from D.C. to A.C., the Corporation had no knowledge that an eliminator was in use. Is it fair to expect them to accept responsibility for apparatus of whose existence they have no knowledge?

With regard to “Enquirer's” points (1) and (2), I would like to say:—

(1) The Corporation appear to be well within the spirit of the Act relating to change-over schemes, having regard to the above circumstances.

(2) No hurt would occur to legal traders if only radio dealers would inform their customers as to what was expected by their

supply authority. All radio dealers should be acquainted with the rules of their local authority if they desire to give their customers full service. Furthermore, radio dealers would benefit by the change from D.C. to A.C. inasmuch as A.C. lends itself much more readily to adaptation for wireless purposes than does the competing system. I do not think “Enquirer” will find genuine radio dealers complaining.

The Edinburgh Corporation have offered to supply a new A.C. eliminator at less than retail cost, and they would therefore appear to be dealing very leniently, and more than justly, with “Enquirer's” case.

“Ohm Sweet Ohm” remarks: “An uncompromising attitude should be adopted, and admittance to the premises refused until the apparatus is duly replaced.” I would recommend this gentleman to also obtain a copy of the general conditions of supply. These conditions are embodied in the application form (which is an agreement). He will probably find a clause to the effect that the Corporation's officials shall be at liberty to inspect wiring and apparatus on consumers' premises at all reasonable times. If, therefore, admittance is refused, the agreement is violated and becomes void.

Again (quoting from “Ohm Sweet Ohm's” letter), “the increasing use of the mains for wireless reception and accumulator charging is not to be lightly flouted by these officials.” Conversely, it can be argued with equal justification, “the regulations laid down by the city of Edinburgh for the protection of its consumers and its electricity supply cannot be lightly flouted by an individual for his own advantage.” These questions of electricity supply generally, and change of system particularly, must be looked at from a broad point of view, and not through the eyes of radio only.

I would further point out that it is by no means certain mains-driven wireless apparatus is included in the terms of the Electricity Commissioners' orders. The vexed question as to whether a supply authority is responsible for this class of apparatus has still to be thrashed out by a test case, and until this occurs it behoves all users of such apparatus to be careful as to the manner in which they individually interpret the various Electricity Acts and Orders. In changing from D.C. to A.C., responsibility by the supply authority would undoubtedly appear to exist (assuming proper application for apparatus has been made), but would be met by the supply of a mains transformer and rectifier (see *The Wireless World*, November 20th, 1929, pages 577 and 578). On the other hand, it is well to remember that the revenue obtained from D.C. eliminators by a supply authority is negligible, whilst the capital cost of such apparatus is heavy. Therefore, if electricity authorities were compelled to shoulder this capital cost, they would be perfectly justified if they protected themselves by making a special tariff for the supply of current to eliminators, etc., and no one desires to see such a state of affairs in existence.

Hornsey, N.8.

A. E. BULLOCK.

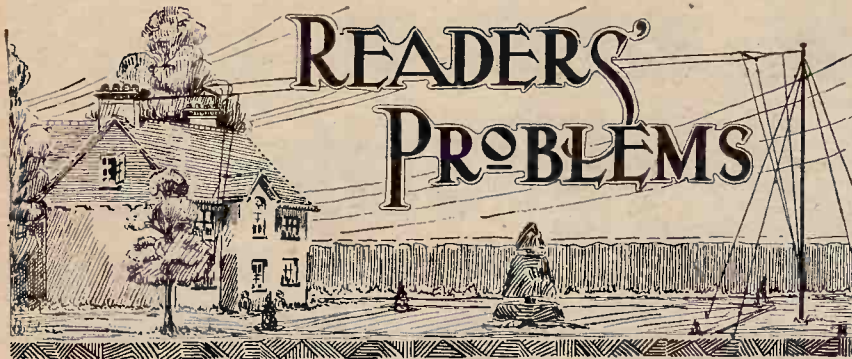

"The Wireless World" Supplies a Free Service of Technical Information.

The Service is subject to the rules of the Department, which are printed below; these must be strictly enforced, in the interest of readers themselves. A selection of queries of general interest is dealt with below, in some cases at greater length than would be possible in a letter.

A G.B. Eliminator.

I believe that it is possible to employ a disused 3-electrode valve of almost any type as a rectifier in an eliminator for providing grid biasing potentials from A.C. mains. If this is correct, will you please give me a diagram of connections? If possible, I should like to make use of a tapped potentiometer of 100,000 ohms which I already have, and of a disused L.F. transformer secondary as a smoothing choke.

S. S. A.

There is no reason why a three-electrode valve, with its anode and grid connected together, should not be used as a rectifier for this purpose. As the current required is extremely small, it is not essential that the valve should have full emission, and so it may be possible to use an obsolete valve that has already done duty in your receiver.

Conventional connections of a grid bias eliminator are given in Fig. 1. Your existing 100,000-ohm resistance will serve quite well as a potential divider, and the transformer winding will probably be satisfactory as a choke.

RULES.

- (1.) A query must be accompanied by a COUPON removed from the advertisement pages of the CURRENT ISSUE.
- (2.) Only one question (which must deal with a single specific point) can be answered. Letters must be concisely worded and headed "Information Department."
- (3.) Queries must be written on one side of the paper and diagrams drawn on a separate sheet. A self-addressed stamped envelope must be enclosed for postal reply.
- (4.) Designs or circuit diagrams for complete receivers or eliminators cannot ordinarily be given; under present-day conditions justice cannot be done to questions of this kind in the course of a letter.
- (5.) Practical wiring plans cannot be supplied or considered.
- (6.) Designs for components such as L.F. chokes, power transformers, complex coil assemblies, etc., cannot be supplied.
- (7.) Queries arising from the construction or operation of receivers must be confined to constructional sets described in "The Wireless World"; to standard manufactured receivers; or to "Kit" sets that have been reviewed.

With regard to the power transformer, it will be clear that its low-voltage winding must supply a pressure suitable for the filament of the valve. It will be all to the good if this winding has a centre-point tapping from which the positive connection may be taken. The other secondary winding should provide some 50 volts or more, depending on the maximum bias required for your set.

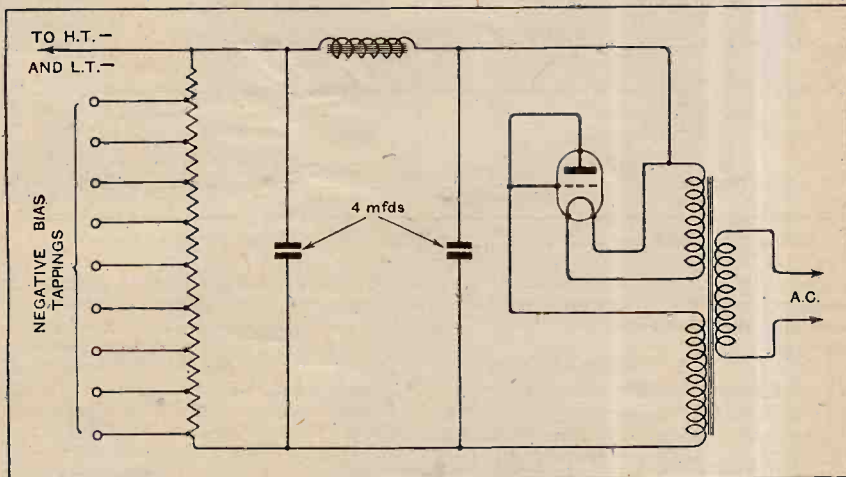

Fig. 1.—A simple grid bias eliminator: an obsolete three-electrode valve may be used as a rectifier.

It is probable that you will find it necessary to decouple the grid circuits of your set, and we would refer you to our reply to R. J. M., given elsewhere.

Meter Indicates Modulation.

It is noticed that the needle of the milliammeter which is connected in series with my anode-bend detector does not remain perfectly steady. Slight fluctuations, coinciding with heavy modulation, seem to take place. Does this indicate that the detector is being overloaded?

H. C. P.

It is quite normal that fluctuations in anode current, due to modulation of the

transmitter, should be indicated by a milliammeter connected in the anode circuit of the bottom bend detector. We think you are confusing the action of this meter with that to be expected of an indicating instrument in the anode circuit of an output valve, which should remain steady, as it is dealing with alternating currents, and not with intermittent uni-directional pulsations.

o o o o

A.C. Filament Heating.

I am thinking of supplying the filament of my output valve with raw A.C. in the manner suggested in your issue of April 9th, but, to avoid the need for obtaining an extra transformer, I propose to join the filament—which is rated at 4 volts—across the rectifier filament winding of the transformer in my eliminator. This secondary winding delivers the correct voltage.

Is there any objection to this plan?

E. B.

This is quite impossible. If you examine a circuit diagram, you will see that the rectifier filament (and consequently the filament heating winding of the power transformer) is positive to the extent of the full H.T. pressure with respect to the output valve filament. Connections such as you propose would introduce a short-circuit across the H.T. supply. It is essential that the output valve filament should be heated from a separate transformer, or from a separate secondary.

Standard Periodicity Mains.

Our supply mains are shortly to be changed from 25 cycles to the standard frequency of 50 cycles. Will you please tell me if my existing eliminator power transformer will be suitable for use under the new conditions, and if the D.C. voltage output is likely to be changed appreciably?

J. H. W.

The extent of change will, strictly speaking, depend on the basis on which your power transformer is designed, but we expect that the alteration in output will be quite negligible, and that the existing eliminator, with its transformer, will still yield satisfactory results.

Decoupled Grid Circuits.

I am building a grid bias eliminator for my receiver, and, before fitting it, should like to decouple all the grid circuits so as to avoid risk of instability brought about by the addition of the eliminator.

The set is a conventional combination of S.G. high-frequency amplifier, anode bend detector, and two L.F. stages (resistance- and transformer-coupled). It is proposed to retain battery bias for the H.F. valve.

Will you please give me the diagram of connections? R. J. M.

The positions of the necessary decoupling resistances and condensers are shown in Fig. 2. It may be pointed out that there is a good deal of latitude in the

secondary. We presume that you have removed the base of the detector valve as recommended; if you have not done so, this is certain to be responsible for a serious restriction of tuning range. Care should be taken to see that the high-potential leads in the detector-grid circuit are kept well clear of earthed objects, such as the metalwork, and that they are as short as possible; the hole in the metal base through which the detector-grid lead is passed to the valve should be large enough to afford a reasonable clearance.

If attention to these points fails to have the desired result in extending the lower limit of the tuning range, you will find it necessary to remove one or two turns from the secondary (and a similar number from the primary) of the transformer.

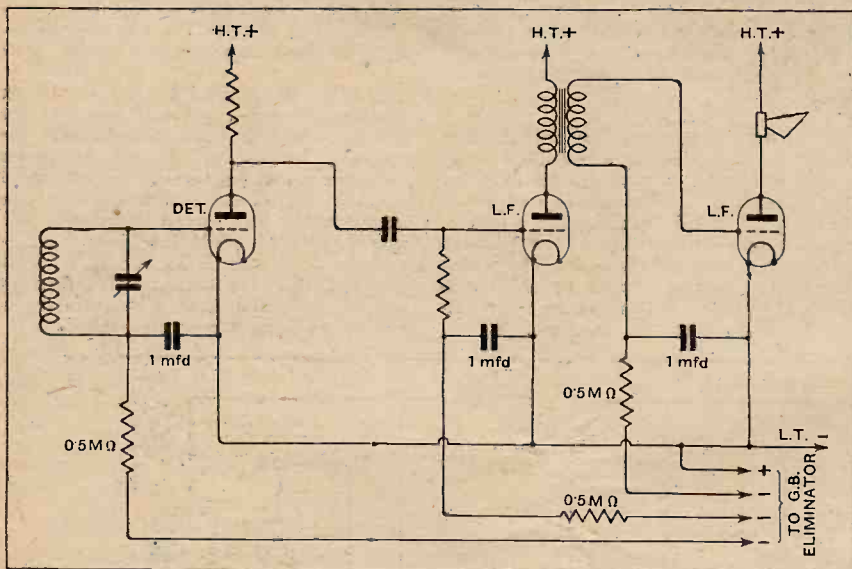

Fig. 2.—Avoiding undesirable interstage couplings: filters for grid circuits.

values of these components, but those suggested are satisfactory in practice. The decoupling resistances may be of the grid-leak type.

o o o o

Excessive Stray Capacity.

My "Record III" receiver is now working satisfactorily, but seems to be incapable of receiving wavelengths as low as that of the "National" transmitter (261 metres). In fact, the lower limit of its tuning range is about 270 metres. Will you please suggest how this may be put right?

I should make it clear that the trouble is in the H.F. transformer circuit, of which the tuning condenser is at zero when the other two dials show readings of 20 or 30 degrees when in resonance. C. F. B.

Assuming that your H.F. transformer is wound in the manner specified, and that the tuning condenser has a minimum capacity no higher than that of the component used in the original receiver as described, it must be concluded that this trouble is due to stray capacities across the detector grid circuit, and consequently across the H.F. transformer

Instability with a Frame Aerial.

My simple 1-v-1 receiver, with an S.G. high-frequency valve and tuned anode coupling, worked quite satisfactorily with an outside aerial of normal dimensions. Now I have moved into a flat, and am wondering whether it would not be possible to convert it for operation with a frame aerial. Will you please give me advice on this subject, and say how the conversion may be made? F. P. M.

Theoretically, this alteration is simple enough. All one has to do in dealing with any receiver (except where reaction is applied to the input circuit) is to join the frame aerial across the grid circuit of the first valve in place of whatever winding may be in that position.

In practice, some difficulty is often encountered in getting the set into a state of satisfactory operation when it is modified in this way. Unless the anode circuit components of the H.F. valve are completely screened, there is quite likely to be sufficient magnetic coupling to provoke instability, even though the frame aerial may be mounted at a considerable distance from the receiver. Again, if the

set is of a type in which normal aerial damping contributes towards stability, the removal of this load may bring about uncontrollable self-oscillation.

Perhaps we should add that a 1-v-1 set, unless of the most ambitious type, is not suitable for long-distance reception with a frame aerial, but, at the address shown on your letter, the set you describe should provide amply loud signals from the local station if stability can be attained.

o o o o

Wavetrap Tuning Capacity.

I have made the wavetrap described in your issue of March 9th, but have so far been unsuccessful in getting it to work. An air dielectric variable condenser of 0.0005 mfd. has been substituted for the compression-type condenser specified. Do you think that this is the cause of the trouble?

F. P. T.

The inductance value of the coil used in this wavetrap is quite low, and, consequently, a tuning condenser with a large maximum capacity—actually in the order of 0.001 mfd.—is required. We expect that your present circuit cannot be tuned to the wavelength of the interfering station.

o o o o

Extreme Efficiency.

In designing a "2-H.F." mains-driven set, in which extreme efficiency is aimed at, would there be any advantage in providing separate series potentiometers for controlling the voltage applied to each screening grid? D. W.

There might be some slight advantage in doing as you suggest, but in practice it is very seldom possible usefully to employ the full magnification attainable from two H.F. stages, and we think that the extra complication would not be justified by results.

FOREIGN BROADCAST GUIDE.

OSLO

(Norway).

Geographical Position: 49° 54' N. 10° 48' E
Approximate air line from London: 712 miles.

Wavelength: 493 m. Frequency: 608 kc.
Power: 60 kW.

Time: Central European (one hour in advance of G.M.T.).

Man announcer. Call: *Hallo! Oslo her.*

Standard Daily Transmissions.

B.S.T. 10.50 Time signal and church service (Sun.); 11.00 news (ex. Sun.); 13.00 to 14.00 records; 16.30 or 17.00 concert; 17.50 Time signal and church service (Sun.); 19.15 weather and news, followed by talks, etc.; 19.30 (Fri.) foreign language lesson; 20.00 time signal and main programme; 21.30 weather and news, followed by concert or dance music; 23.00 to 00.30 (Sun.) dance music. Occasionally relays foreign stations.

Closing down words: *Godnat, Goodnat.*

Look at these Wonderful Characteristics!

The New

MARCONI

Filament Volts	2.0
Filament Current	0.2 amp.
Anode Volts	150 max.
Amplification Factor *	6.5
Impedance *	2,300 ohms.
Normal Slope *	2.8 m.a. volt.

*At Anode Volts 100 Grid Volt 0.

Price
15/-



FIRST AND FOREMOST
IN RADIO

No other Valve can shew such figures! Verb sap!

THE MARCONIPHONE COMPANY, LIMITED, 210, Tottenham Court Road, London, W.C. 1.

MISCELLANEOUS ADVERTISEMENTS.

NOTICES.

THE CHARGE FOR ADVERTISEMENTS in these columns is :
12 words or less, 2/- and 2d. for every additional word.

Each paragraph is charged separately and name and address must be counted.

SERIES DISCOUNTS are allowed to Trade Advertisers as follows on orders for consecutive insertions, provided a contract is placed in advance, and in the absence of fresh instructions the entire "copy" is repeated from the previous issue : 13 consecutive insertions 5% ; 26 consecutive, 10% ; 52 consecutive, 15%.

ADVERTISEMENTS for these columns are accepted up to **FIRST POST on THURSDAY MORNING** (previous to date of issue) at the Head Offices of "The Wireless World," Dorset House, Tudor Street, London, E.C.4, or on **WEDNESDAY MORNING** at the Branch Offices, 19, Hertford Street, Coventry ; Guildhall Buildings, Navigation Street, Birmingham ; 260, Deansgate, Manchester ; 101, St. Vincent Street, Glasgow, C.2.

Advertisements that arrive too late for a particular issue will automatically be inserted in the following issue unless accompanied by instructions to the contrary. All advertisements in this section must be strictly prepaid.

The proprietors retain the right to refuse or withdraw advertisements at their discretion.

Postal Orders and Cheques sent in payment for advertisements should be made payable to **LIFFE & SONS Ltd.**, and crossed **Notes being untraceable if lost in transit should not be sent as remittances.**

All letters relating to advertisements should quote the number which is printed at the end of each advertisement, and the date of the issue in which it appeared.

The proprietors are not responsible for clerical or printers' errors, although every care is taken to avoid mistakes.

NUMBERED ADDRESSES.

For the convenience of private advertisers, letters may be addressed to numbers at "The Wireless World" Office. When this is desired, the sum of 6d. to defray the cost of registration and to cover postage on replies must be added to the advertisement charge, which must include the words Box 000, c/o "The Wireless World." Only the number will appear in the advertisement. All replies should be addressed No. 000, c/o "The Wireless World," Dorset House, Tudor Street, London, E.C.4. Readers who reply to Box No. advertisements are warned against sending remittance through the post except in registered envelopes ; in all such cases the use of the Deposit System is recommended, and the envelope should be clearly marked "Deposit Department."

DEPOSIT SYSTEM.

Readers who hesitate to send money to unknown persons may deal in perfect safety by availing themselves of our Deposit System. If the money be deposited with "The Wireless World," both parties are advised of its receipt.

The time allowed for decision is three days, counting from receipt of goods, after which period, if buyer decides not to retain goods, they must be returned to sender. If a sale is effected, buyer instructs us to remit amount to depositor, but if not, seller instructs us to return amount to depositor. Carriage is paid by the buyer, but in the event of no sale, and subject to there being no different arrangement between buyer and seller, each pays carriage one way. The seller takes the risk of loss or damage in transit, for which we take no responsibility. For all transactions up to £10, a deposit fee of 1/- is charged ; on transactions over £10 and under £50, the fee is 2/6 ; over £50, 5/-. All deposit matters are dealt with at Dorset House, Tudor Street, London, E.C.4, and cheques and money orders should be made payable to Liffe & Sons Limited.

SPECIAL NOTE.—Readers who reply to advertisements and receive no answer to their enquiries are requested to regard the silence as an indication that the goods advertised have already been disposed of. Advertisers often receive so many enquiries that it is quite impossible to reply to each one by post.

"WIRELESS WORLD" INFORMATION COUPON

This Coupon must accompany any Question sent in before

MAY 14th, 1930

For Particulars of Free Service, see Rules on page 495.

Mention of "The Wireless World," when writing to advertisers, will ensure prompt attention.

B & J

**ALL WIRELESS
WORLD COILS,
DIALS & CABINETS**

Short Wave Coils, etc.

B & J. Wireless Co.

2, 3, & 4, Athelstane Mews, Stroud Green Rd., N.4.
Archway 1695.

*The simplest,
neatest aid
to selectivity*

Connect the Belling-Lee "Spadenser" to your aerial lead. In every case it will greatly increase the selectivity and in most cases it will entirely eliminate the unwanted station. This new idea combines a series condenser with a Belling-Lee clip-on Spade Terminal. On occasions when the extra selectivity is not required the "Spadenser" is reversed. Write to us for Belling-Lee Handbook "Radio Connections."

only 2/6

BELLING-LEE
FOR EVERY RADIO CONNECTION.

Advertisement of Belling & Lee Ltd.,
Queensway Works, Ponders End, Middlesex.

□ □ □ buy radio with economy—
buy by part exchange.

□ □ □ send where thousands of
your fellow-readers send—
where radio was sold—eleven
years ago.

appleby's

CHAPEL STREET, MARYLEBONE,
LONDON, N.W.1.

Telephone: Paddington 8828 (3 lines).

**MAHOGANY
RADIO
GRAMOPHONE
CABINET.**

Hand French polished, satin finish

Will take gramophone, any set
up to 22" x 10" x 16", and loud-
speaker and battery compart-
ment 18" high, 22" wide and
16" deep.

Deliver free England and Wales.
Scotland 2/6 extra.
Orals 7/6 extra, returnable.

**F. DIGBY, 9, The Oval,
Hackney Rd., London, E.2.**

Phone :
Bishopsgate 6456

RECEIVERS FOR SALE.

SCOTT SESSIONS and Co., Great Britain's Radio Doctors.—Read advertisement under Miscellaneous. [0264]

HIRE a McMichael Portable Set, by day or week, from Alexander Black, Wireless Doctor and Consultant, 55, Ebury St., S.W.1. Sloane 1655. [0328]

BURNDEPT 5-valve Ethogrand, with valves and coils, £7/10; Marconi V2, 30/-; ditto, with amplifier, 50/-; carriage extra.—James Scott and Co., Radio Engineers, Dunfermline. [0333]

McMICHAEL Super Screened Four Portable; cost 35 guineas, price £18, as new.—Saul, 77, Headroomgate Rd., St. Anne's, Blackpool. [9252]

PHILIPS 2511 All Electric 4-valve Receiver, 240v.; cost £37/10, price £26; Philips 2013 moving coil loud speaker, cost 14 guineas, price £10; all as new.—Saul, 8, Ansdell Rd., S. Ansdell, Blackpool. [9252]

PORTABLES, unique bargains, purchased surplus contract stock, well known manufacture, 1930 models; 5-valve cabinet type portable receivers, compact size, collapsible handle, Mullard or equivalent Ring valves, best British components, drum drive condensers, power H.T. charged unspillable accumulator, really exceptional performance and fully guaranteed; oak £8/7/6, walnut £8/12/6, complete; half usual price; crate, packing, and carriage 5/- extra; limited number available; remittance with order.—Powers and Son, Radio Department, 168, Aston Rd., Birmingham. [9257]

NATIONAL 5-valve Portable, 4 months old, new H.T.; £8 or near offer. [9277]

McMICHAEL Super Range 4-valve Portable, used for demonstration only, unscratched, new H.T.; £17/10, or near offer.—Gregory, Cliff St., Cheddar. [9277]

PHILIPS 5-valve, 200v. 50 cycle, all-main, nearly new; £16.—P., 8, Hurlingham Rd., S.W.6. [9271]

5-VALVE S.G. A.C. main, any voltage receiver, new, complete; £14.—43, Catesby St., Old Kent Rd., London, S.E.17. [9266]

1930 Everyman Four Receiver, as per Wireless World specification, just built for customer who cannot now take it; accept £18/10, including valves (2 4, or 6 volt); cabinet make finish.—Box 5810, c/o The Wireless World. [9265]

REFLEX Neutrodyne Two, including Ideal transformer, valves; £3.—Guest, 1a, Thornton Hill, Wimbledon. [9263]

McMICHAEL Super Range Portable Four, hardly used; £18/10, bargain.—Box 5879, c/o The Wireless World. [9288]

A FEW Sample Atwater Kent Wireless Sets for Disposal, special opportunity to secure one of these superb radio sets.—Enquire sole concessionaires, Fredk. J. Gordon and Co. Ltd., 92, Charlotte St., W.1. Tel. : Museum 3811. [9282]

PAM-16 Power Amplifier, 200-240 volts A.C. 50 cycles, complete with 4 valves, cable and switch, cost £35/18/6, practically new, £27; Grassman 240v. moving coil loud-speaker chassis, £6/10, cost £8/15; Woodruff pick-up, £1/10.—P. K. Hoyle, Slaithwaite, Yorks. [9281]

CELESTION Combined Set and Loud-speaker, 4 2-volt Mullard valves, new 18 A.H. Exide accumulator, Phillips 105 volt high tension supply unit, with Regeitone battery charger and Foster transformer. 240, 105 volts if required; cost over £40, offers.—Dora, Eastcote Point, Pinner. [9276]

5-VALVE S.G. Push-pull Ferranti Parts, receiver, double mahogany case; £8.—Side door, 43, Belsize Av., Hampstead. [9290]

MAGIC Three, including valves, coils and cabinet, perfect; £3; buzzer warmerer, 10/.—Pinnington, 175, Coteford St., Tooting, S.W.17. [9292]

WHY Run? from shop to shop; send us a postcard, we will send you goods per return; complete set of parts, 5-valve set, 30/-, with Anglo-American system of wiring.—Anglo-American Radio Co., 46, Church Rd., Acton, W.3. [9309]

BERCLIF D.C.2 All Mains Receiver, 200 to 250 volts D.C.; price £14/10; with valves and royalties, suitable for M.C. speaker; particulars free; trade inquiries specially invited.—Simmonds Bros., Shireland Rd., Smethwick. [8734]

YOUR Old Receiver or Components Taken in Part Exchange for New; write to us before purchasing elsewhere, and obtain expert advice from wireless engineer of 25 years' professional wireless experience; send a list of components or the components themselves, and we will quote you by return post; thousands of satisfied clients.—Scientific Development Co., 57, Guildhall St., Preston. [9026]

MARCONI 23a 2-valve Sets, complete with valves, speaker, batteries, etc.; list price £12/13/3 £7/2/6, carriage paid.—Miller and Son, Garfield St., Kettering. [9306]

FERRANTI S.G.3, new, splendid reception, speaker, etc., all in solid oak cabinet (buying mains set); offers.—Daniel, 14, Sunny Hill, Hendon. [9352]

Receivers for Sale.—Contd.

PHILIPS Portable, quite as new; £20.—Lownds, The Cottage, Old Lenton, Nottingham. [9350]

LANGHAM 5-valve Portable, at half price, brand new unused 18 guinea set for 9 guineas.—Premier Supply Stores, 165, Fleet St., E.C.4. [9349]

PORTABLE Power Amplifier and Gramophonic Repeater, with 400v. anode converter (12v. input), L.S. 6a. output, ideal for outdoors, dances, etc.; £14.—18, Lothair Rd., N.4. [9344]

McMICHAEL Screened Grid Super Range Portable 4, as new; 18 guineas, or offer.—Box 5894, c/o The Wireless World. [9341]

COSSOR Melody Maker, including valves, also Pentode, 120 C.A.V., H.T. (new), 2 v. Exide accumulators; what offers?—E. A. B., 134, Putney Bridge Rd., S.W.15. [9357]

LEWCOS 3-valve Screened Grid Chassis; cost £7/7, bargain, £4/4; perfect.—71, Pershore Rd. South, King's Norton, Birmingham. [9334]

NEW Unused Aonic 5-valve 16 Guinea Portable; £8/10, carriage paid.—Watson, c/o "Abbotsford," Hinckley. [9327]

ELSTREE Six (Burne-Jones), full of valuable parts and valves, complete, in Camco cabinet; 5 guineas, carriage and packing free.—Radio Corner, Hinckley, Leics. [9328]

LOTUS'S 1930 Screen Grid Pentode Three, in fine oak cabinet containing batteries, Brown's cone speaker, Hegra pick-up, complete manufacturer's product, not home assembled, magnificent receiver, just cost, £18, money wanted, accept £10/10 lot; also month old Avometer (13 instruments in one), only £5; other components; please state needs; receiver heard by appointment.—Clark, 78, Lavender Sweep, Clapham Junction, S.W.11. [9324]

GECOPHONE 2-valve Set, as new; 35/.—250, Elgin Av., Maida Vale. [9319]

G.E.C. Screened Grid Portable; cost £24/3; nearly new, perfect; £16.—"Lynton," Southmead Av., Millsborough Rd., Redditch. [9316]

OSRAM Cossor, Mullard, or any set constructed and delivered for the cost of components only by radio engineer commencing own business.—Address first instance Box 5881, c/o The Wireless World. [9281]

EDISWAN/B.T.H. All-mains Receiver, 3v., latest model, D.C. 200-250v., new last month; cost £21, magnificent bargain £16/10 complete; view week-end.—English, 7, Stamford Av., Brighton. [9313]

ACCUMULATOR HIRE.

DON'T Buy Accumulators or Dry Batteries, join our C.A.V. low- and high-tension accumulator hire service, the largest and best in London; better and cheaper reception with no trouble; regular deliveries within 12 miles of Charing Cross; no deposit, payment on each delivery or by quarterly subscription; over 10,000 satisfied users; explanatory folder post free; phone or write to-day.—Radio Service (London), Ltd., 105, Torriono Av., N.W.5. Phone: North 0623-4-5. [8751]

BATTERIES.

WET H.T. Replacements.—Sacs (capped or uncapped), highest grade, No. 1, 10d. per doz.; No. 2, 1/9 per doz.—See below.

ZINCS—Best quality (wired), No. 1, 8d. per doz.; No. 2, 9d. per doz.; orders valued 5/- carriage paid, otherwise 6d. for postage.—British Battery Co., Clarendon Rd., Watford, Herts. [0258]

H.T. Accumulators, Exide 5,500 m.a. hours, 800 volts, in very good condition; £25, or will separate as required.—Dominion Gramophone Records, Ltd., 55-7, Great Marlborough St., W.1. [9355]

RADIOLENE, tools, can rolling machine L.68h., 17/6; can former, 5/- and punches; L.35 horse-hair sieve L.59, 3/-.—G. Alderson, DorrIDGE, Birmingham. [9314]

CHARGERS AND ELIMINATORS.

CHEBROS—Chebros for all types of transformers and chokes, high grade instruments at a very moderate price; enquiries invited.—Chester Bros., 244, Dalston Lane, London, E.8. [5290]

TANTALUM and Lioniun for A.C. Rectifiers; for inexpensive chargers; blue prints for H.T. and L.T., 1/- each; Lioniun electrodes, 2-3 and 5-8 amps.—Blackwell's Metallurgical Works, Ltd., Garston, Liverpool. [8298]

DYNIC A.C. H.T. Eliminator, £3; Regentone, £3; Philips L.T. charger, £2/10; Ferranti trickle chargers, £1/10; carriage extra.—James Scott and Co., Radio Engineers, Dunfermline. [0335]

ZAMPA H.T. Eliminator Kit Comprising, rectifying unit (incorporating transformer, condensers, Westinghouse H.T.3), necessary condensers, choke, terminals, baseboard, etc., output 120 volts at 20 m.a., complete; 45/-; 7 days' approval against cash; other Zampa kits and transformers on request.—Mic Wireless Co., Market St., Wellingborough. [9300]

B31

Advertisements for "The Wireless World" are only accepted from firms we believe to be thoroughly reliable.

SPECIALLY DESIGNED
for the
MULLARD "MASTER TWO."

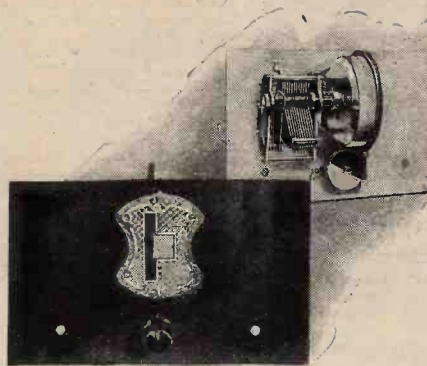

THE LOTUS
PANEL ASSEMBLY

Specified for the "Master Two," the Lotus Panel Assembly consists of a combined single drum dial and condenser and a separate reaction condenser, all mounted on a handsome black finished aluminium panel, with silver oxidised escutcheon plate.

Cash Price 21/-

Insist upon the Lotus Panel Assembly, as it is only in this way that you can obtain the perfection of results that the Mullard "Master Two" is designed to give.

LOTUS
PANEL ASSEMBLY

Garnett, Whiteley & Co. Ltd.,
Lotus Works, Mill Lane,
Liverpool.

Causton

Chargers and Eliminators.—Contd.

PHILIPSON'S Safety High Tension Supply Units for A.C. and D.C. Mains, 200-250 volts 40-60 cycles, also 230 volts 25 cycles.

10/- Down and Small Monthly Payments Secures the Finest H.T. Supply Available.

PHILIPSON'S Safety H.T. Units are Guaranteed for 12 Months Against All Defects.

ALL Models Sold on 7 Days' Approval to Ensure Complete Satisfaction.

PHILIPSON'S Safety H.T. Units are the Cheapest to Install and the Cheapest to Run; £1/17/6 to £6.

WRITE for Our Booklet "Radio Power," which gives illustrations and full particulars.

PHILIPSON'S Safety Loud Speaker Output Filters for All Receivers, power valve, or Pentode; a remarkable output filter at a very low price; 16/6.

PHILIPSON and Co., Ltd., Radio Engineers, Astley Bridge, Bolton. Phone: 2038 Bolton. [0318]

SAVAGE'S Specialise in Wireless Power from the Mains, reliable apparatus at reasonable prices.

SAVAGE'S—Transformer laminations and Bakelite bobbins; intending home constructors should write for list.

SAVAGE'S—Reliable smoothing condensers, 1,500 volt D.C. test, 1 mfd., 2/-; 2 mfd., 3/-; 4 mfd., 5/3; 500 volt D.C. test, 1 mfd., 1/6; 2 mfd., 2/3; 4 mfd., 3/9.

SAVAGE'S—Super smoothing and output chokes, many types available; write for list.

SAVAGE'S—Mains transformer for Westinghouse H.T.4 unit, with additional winding, 4 volts centre tapped 3 amps, 23/-; transformers for other Westinghouse units available.

SAVAGE'S—Mains equipment for new Foreign Listeners Four, transformer N.F.L.4, 33/-; smoothing choke, C32G, 20/-; output choke C320, 20/-.

SAVAGE'S—Mains transformer B.T.4, 500-0-500 volts, 120 m. amps., 7½ volts 3 amps., 6 volts 3 amps., 4 volts 2 amps., 4 volts 1 amp., 4 volts 1 amp., all centre tapped, specially developed for automatic bias; 57/6.

SAVAGE'S—Mains transformers and power chokes are carefully and individually constructed from first class materials, with an exceptionally generous margin of safety.

SAVAGE'S, 146, Bishopsgate, London, E.C.2. Phone: Bishopsgate 6998. [9165]

SURPLUS Bargains by Post.—New originally, 21/- eliminator chokes, 40 henry, 10/6; L.F. output chokes, 30 henry, 10/6; 5,000 ohm wire wound resistances, 1/-; post free on approval; cash with order.—Oliver, 325, Kennington Rd., London, S.E. [9325]

EDISWAN Low-tension Smoothing Units, containing 2 T.C.C. electrolytic condensers, 2 chokes, volt-meter, rheostat, etc., for A.C. or D.C., 32/6, carriage paid; B.T.H. A.C. eliminators, 5 m.a. output, complete with R.H.1 valve, 42/6, carriage paid.—Miller and Son, Garfield St., Kettering. [9307]

TRICKLE Chargers, A.C. mains, for 4- and 6-volt accumulators, output 0.5 amp., no upkeep; 16/6, carriage paid.—Benoit, 4, Manor Gardens, Gunnersbury Lane, London, W.3. [9326]

RADIELLE Model G.P. (200-250 A.C.) output 200 volt 55 ma., and 2 variable tappings; cost £9/17/6, sell £3/10; brand new, sent c.o.d.—Priestley, 74, Aberdeen Rd., Highbury, London, N.5. [9331]

CABINETS.

DIGBY'S Cabinets.—Table models in solid oak and mahogany; from 11/6 to 71/-.

DIGBY'S Cabinets, fitted with Radion or Resiston ebonite if required.

DIGBY'S Cabinets.—Pedestal model, with separate battery components; from 56/- to £12.

DIGBY'S Cabinets Made to Customers' Own Designs.

DIGBY'S Cabinets.—Write for new 16-page art catalogue.—F. Digby, 9, The Oval, Hackney Rd., E.2. Phone: Bishopsgate 6458. [0128]

KAY'S Cabinets, the greatest range of pedestal cabinets in the kingdom; original creative designs at prices 50% lower than elsewhere; quotations for specials by return; delivery at short notice guaranteed.

RADIOGRAM Cabinets.—A variety of really practical and exclusive models from 60/-; illustrated lists free.

H. KAY, Wireless Cabinet Manufacturer, Mount Pleasant Rd., London, N.17. Phone: Walthamstow 1626. [8963]

A LIMITED Number of Magnificent Radio-gramophone Cabinets, brand new, panel size 18in. x 7in., oak 26, mahogany 27; larger size, with double doors, panel 21in. x 8in., oak £11, mahogany £12/10; portable cabinets (suitcase type), 30/-; transportable (oak or mahogany), £2; cabinets with oval panel opening, suit 2- or 3-valve set, 17/6; carriage extra.—James Scott and Co., Radio Engineers, Dunfermline. [0334]

The Brilliant "GRASSMANN" Moving Coil Loudspeaker



6 volt, 100 volt D.C., 240 volt D.C.
£4 - 17 - 6
 240 volt A.C. NO HUM model
£8 - 5 - 0

YOUR DEALER WILL DEMONSTRATE

Ask your Dealer to let you hear a Grassmann Moving Coil. You will immediately agree with Mr. J. H. Reyner's remarks in the March issue of Wireless Magazine.

THE FINEST AND LIGHTEST MOVING COIL MADE!

The best dealers stock "Peter Grassmann" products, but should you have any difficulty send us your dealer's name and address and we will arrange a demonstration for you, so that you may hear the natural reproduction of Radio—made possible only by the introduction of the Peter Grassmann Moving Coil Loudspeaker!

"Peter Grassmann" Moving Coil Speakers, Individual Dynamic Units and Chassis, also Electrical Pick-up complete with Tone Arm and Volume Control, are obtainable from all good dealers.

ROTOR ELECTRIC Ltd.
 2/3, Upper Rathbone Place, London, W.1.

OVERSEAS READERS WE SPECIALISE IN OVERSEAS BUSINESS.

PARTS, SPEAKERS, ELIMINATORS OR COMPLETE SETS

Write and tell us exactly what you require and we will buy it for you. It is our business to select suitable apparatus and thus ensure satisfaction to the user. Payment may be made either through "The Wireless World" deposit system, see page 10 or direct to us.

THE OVERSEAS TRADING CO.
 144, St. Vincent Street, Glasgow.
 Scotland.
 Telegrams "Tenacity," Glasgow.

The Autocar EVERY FRIDAY, FOURPENCE

COILS, TRANSFORMERS, ETC.

TRANSFORMERS and Chokes for Battery Elimina-tors.—Chester Bros., 244, Dalston Lane, London, E.8. [8652]

JAMES 1930 Binowave Coils, types A.B.C.; 12/- each.—27, Miles Hill Av., Leeds. [9275]

FERRANTI Output Transformer, 25 to 1 ratio, guaranteed sound; 12/6.—15, Listing Mills, Gomersal, near Leeds. [9305]

BEROLIF Coils, the standard of excellence, for all "Wireless World" receivers; latest lists post free; trade supplied, all quantities.—Stimmonds Bros., Shireland Rd., Smethwick. [8735]

FOREIGN Listeners' Four.—Coils, 30/- set, boxes 18/- set; mains transformers, 29/-; chokes, 18/-; all parts; send for list.

KILO-MAG Coils, 33/-; Record III, 35/-; 1930 Everyman, 42/6; kit coils, 37/6; all "W.W." components; metal cabinets from 25/-.

STOTT, Townhead Radio-Works, Duke St., Rochdale. [9325]

ONE Power Transformer. P240 volts, 50 cycles. S6.5/0/6.5v., 10 amps., new; £2/10.—Dominion Gramophone Records, Ltd., 55-7, Great Marlborough St., W.1. [9356]

DYNAMOS, ETC.

ONE Newton motor generator, comprising 240-volt 50 cycles motor and starter, direct coupled to D.C. generator, volts 16/330/8, amps. 4.5/1.5/4.5, almost new; £48.—Dominion Gramophone Records, Ltd., 55-7, Great Marlborough St., W.1. [9354]

GRAMOPHONES, PICK-UPS, ETC.

H.M.V. Machine and Loewe Pick-up, complete outfit, perfect order; 30/- only.—108, Milton Rd., W.7. [9261]

ONE Induction Disc Gramophone Motor, 110 volts, 60 cycles, new, complete; £5.—Dominion Gramophone Records, Ltd., 55-7, Great Marlborough St., W.1. [9358]

PHILIPS Pick-up, latest type, Watmel arm to fit; £2.—Mew, 14, Home Park Rd., S.W.19. [9318]

PICTURE RECEIVER APPARATUS.

TELEVISION—Scanning discs, Neon tubes, experimental models made.—John Salter, Member Television Society, Featherstone Buildings, Holborn, W.C. [9154]

TELEVISION—Free advice by J. Lipowsky, A.M.I.B.E., Fellow of the Television Society; demonstrations daily between 11 a.m. and 11.30 a.m. Scanning discs, Neon tubes, phonic wheels and coils, motors, resistances; complete televisions on terms or cash.—Bishop Stores, 309, Roman Rd., E.3. East 6079. [9262]

LOUD-SPEAKERS.

BAKER'S SELHURST RADIO 36-page Booklet, "Sound Advice is Yours for the Asking"; write now for new edition; see displayed advertisement on page 14. [0231]

VIBRO-SKIN Special Leather for Fixing the Diaphragm of the Moving Coil Loud Speaker, price 2/- per piece 1 1/4 in. square, 1/6 per piece 9 in. square; post free; cash with order.—The Alder Leather Co., 3, Southwark St., S.E.1. Tel.: Hop 4448. [0330]

R.K. Moving Coil, £3; 2 old M.C. speakers, £1 each; new moving coil speakers, 220v. A.C., £3; carriage extra.—James Scott and Co., Radio Engineers, Dunfermline. [0336]

LINEN Speakers, fit the Perfecta chuck extension for 100% results; 1/3; post free.—Douglas Briggs, Radio Engineer, Newport, Mon. [9124]

PERARDUA Moving Coil Reproducers.—These superlative instruments may be obtained for 15/- down, balance by 5 equal monthly payments; cash prices, 230-volt D.C., £3/3; 6-volt, £3.—R. Verers, 4, York Rd., Maidenhead. [9169]

SILK Gauze, finest quality, gold finish; 1/3 sq. ft.—Douglas Briggs, Radio Engineer, Newport, Mon. [9123]

LIQUIDATOR'S Clearance.—250 speakers; 6/- each, carriage forward, or e.o.d., black crystalline finish, 2 1/2 in. high, 1 1/4 in. flare, weight 7 1/2 lb., splendid condition and tone; special prices for quantities.—Westall, Kenilworth Rd., St. Aunes-on-Sea, Lancs. [9274]

AMPLION Lion Power Chassis (£8 model), perfect condition, 4ft. baffle, £5; Burndept pick-up, 12/6.—Gordon, 74, Delancey St., Regent's Park, N.W.1. [9298]

MOVING Coil Magnet Pots, ready machined; 4/6, ex stock, genuine bargain; 7 days' approval against cash.—Mic Wireless Co., Market St., Wellingborough. [9301]

MARCONIPHONE Moving Coil Speaker Unit, 6 volts, new; £4.—Copolow Bridge Post Office, Portsmouth. [9304]

ULTRA Air Chrome Speaker (14x14); cost 52/-, sell 25/- unused.—Lloyd, Cheadle, Staffs. [9292]

"ALL MAINS"

Suit any electric supply, A.C. or D.C.

NO AERIAL EARTH H.T. BATTERY L.T. ACCUMULATOR TROUBLE

5 valve receiver, with self-contained aerial, loud speaker, long and short wavelengths, one dial tuning, will receive principal British and foreign stations. D.C. model £18.16s., complete A.C. " £17.17s. "



Illustrated Catalogue post free, or call.

I.D.S. 4, GOLDEN SQ., (Piccadilly Circus), LONDON, W.1. Phone: Gerrard 2437.

A STAMPED ENVELOPE

will bring you our great

MAY BARGAIN LIST

Electrical Gear
 Radio Apparatus
 Measuring Instruments

Many bargains at Sacrifice prices.

ELECTRADIX RADIOS

218, Upper Thames Street, E.C.4.
 City 0191. Electradix, Cent, London.

NEW MAGNAVOX 1929 MOVING COIL SPEAKERS

for **£3-3-0** each

Original list price **£8-0-0**

Messrs. WILBURN & CO., 23 Bride Lane, Ludgate Circus, E.C.4, have to offer by arrangement a limited number of the above instruments (without input transformer). These speakers are new and in the manufacturer's sealed cases. Field winding for 6 volts .65 amps.

8 a.m. to 6.30 p.m. Phone: Central 6004. 1.30 p.m. Saturdays.

EXACT TUNERS

250 to 2,000 metres.

No further coils are required, tuning is as simple as A.B.C., see "Wireless World," January 25th. We can strongly recommend these tuners. Send postcard for particulars and Circuits FREE to

THE EXACT MANUFACTURING CO.
 Croft Works, Priory Place, COVENTRY.

Mention of "The Wireless World," when writing to advertisers, will ensure prompt attention.

Loud-Speakers.—Contd.

EPOCH Moving Coil Speakers are Masterpieces, designed and produced by master engineers.

EPOCH Moving Coil Speakers are the Standard by which other Speakers are Compared.

EPOCH Moving Coil Speakers are in Use in Many Editorial Offices.

EPOCH Moving Coil Speakers are in Use in Several Famous Laboratories.

EPOCH Moving Coil Speakers are in Use in Many Broadcasting Stations.

EPOCH Moving Coil Speakers are in Use by Most Prominent Musicians.

EPOCH Moving Coil Speakers Bring Unbounded Joy to Thousands upon Thousands of Homes.

EPOCH Moving Coil Speakers, the only speakers that give clear, uncoloured reproduction.

EPOCH Moving Coil Speakers do Render Speech Perfectly and Music Correctly.

EPOCH Moving Coil Speakers Provide the Perfect Illusion of the Artist's Presence.

EPOCH Moving Coil Speakers Represent the Finest Intrinsic Value Ever Offered.

EPOCH Moving Coil Speakers are Guaranteed for a Year, but last for ever.

EPOCH Moving Coil Speakers Bring the Grand Concert out of the Most Modest Set.

EPOCH—You can hear a hundred moving coil speakers, but Epoch is different.

EPOCH—If you own the best set, only by Epoch can you confirm it.

EPOCH—Away with the tin can and cracked banjo reproduction, and install an Epoch.

EPOCH—Away with the drumminess, droniness and huskiness of the average moving coil speakers.

EPOCH—The clearest, sharpest, cleanest reproduction—a marvel of accuracy and beauty.

EPOCH Moving Coil Speaker Models from £2/10 to £30.

EPOCH Moving Coil Speakers.—Models for every requirement and taste.

EPOCH Permanent Magnet Moving Coil Speakers.—Nine models from £3/15.

EPOCH Permanent Magnet Moving Coil Speakers Require no Mains or Batteries.

EPOCH Permanent Magnet Speakers are more Sensitive than most Energised Moving Coil Speakers.

EPOCH Energised Models are the Finest ever put on the Market.

EPOCH Super Cinema Speaker has Created the Biggest Sensation for Many Years.

EPOCH Super Cinema Model is many times as Sensitive as the so-called Supers.

EPOCH Super Cinema Speakers give Enormous Volume from a 1-watt Amplifier.

EPOCH Super Cinema Speakers are used on many 100-watt Amplifiers and never "rattle."

EPOCH Super Cinema Model is Standard on several Talkie Equipments.

EPOCH Super Cinema Model is already in use in over 200 Cinemas.

EPOCH Super Cinema are the only Moving Coil Speakers used in Large Theatres, unaided.

EPOCH Super Cinema Speakers provide alone the Upper as well as the Lower Register.

EPOCH—Other Moving Coil Speakers require the help of exponential horns to provide depth.

EPOCH—A list of many prominent cinemas using the Speakers supplied on request.

EPOCH Speakers are not Made of Tin or Aluminium Stampings, but are sound, solid, engineering jobs.

EPOCH Heartily Invite Comparison, on all counts, with any make, regardless of price or claims.

EPOCH—Don't accept our quality claims without verification, but don't accept any other maker's either.

EPOCH—Order one of 7 days' approval, and test with a switch-over; the only real test.

EPOCH Moving Coil Speakers may be heard in our Demonstration Room Daily.

EPOCH—Our demonstration room is in the heart of London.

EPOCH—Its accessibility has been studied for the convenience of callers.

EPOCH—If you cannot call, write for booklet W.S.3, and approval terms.

EPOCH RADIO MANUFACTURING Co., Ltd.—Farringdon Av. (near Ludgate and Holborn Circuses). Phone: Central 1971. [8983]

1925-1930 STILL BEST ON TEST



Baker's Super Power Moving Coil Speaker

IDEAL for the home as well as the Cinema

Messrs. THOMSON & BROWN BROS., Ltd., Dundee, write:

"Our clients, Messrs. Lang & Sons, Radio Engineers, Whitehall St., Dundee, inform us that the two Super Power Moving Coil Speakers they installed in La Scala Picture House, Cupar, Fife, are being used without the aid of any exponential Horns—and the quality of reproduction from the highest to the lowest notes is really wonderful."

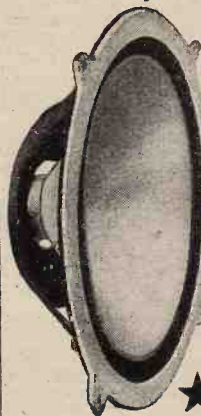

BAKER'S LINEN DIAPHRAGMS

for Moving Coil Speakers are becoming increasingly popular.

WRITE FOR OUR FREE 36-PAGE BOOKLET, "SOUND ADVICE," NOW.

★ DEMONSTRATIONS AT CROYDON DAILY.

BAKER'S 'Selhurst'

RADIO
Pioneer Manufacturers of Moving Coil Loud Speakers

Offices: 89, Selhurst Road, S. Norwood, S.E.23
Works and Demonstration Room: 42, Cherry Orchard Road, E. Croydon
★ Telephone: Croydon 1618

TRANSMITTERS.

CHEBROS. Chebros. Chebros transformers and chokes of all descriptions, special transformers for transmitting and modulation; chokes a speciality; enquiries invited.—Chester Bros., 244, Dalston Lane, London, E.8. [5240]

VALVES.

AMPLIFIER Valve.—If you require power you cannot do better than one of these:—

FILAMENT Volts 6, plate volts 400 (maximum), grid bias 84 volts (approx.), impedance 800 ohms, amplification factor 3.8, mutual conductance 4.35 m.a./volts; price £5/10; see article "The Wireless World," 24th July, 1929, then send to North London Valve Co., Ltd., 22½, Cazenove Rd., Stoke Newington, London, N.16. [9142]

GUARANTEED Perfect Order, 5 P.M.254s. 10/-; P.M.4, 7/-; P.M.3, 7/-; 3 Marconi D.E.L.410, 6/-; D.E.P., 9/-.—Stewart Dellefure, Grantown-on-Spey. [9311]

FIVE Mullard D.O.60 Valves, new, each £3; 5 Cunningham 350 volts, 45 Watt power, fl. 7.5v., H.T. up to 450v., each £1/10.—Dominion Gramophone Records, Ltd., 55-7, Great Marlborough St., W.1. [9357]

L.S.6A. B.12, 15/- each; P.M.14, 12/6; P.M.6, P.M.5, D.E.5B., 5/- each; A.F.3 transformer, 12/-.—46, St. Stephens Rd., Bow, E.3. [9337]

COMPONENTS, ETC., FOR SALE.

BELLING-LEE Panel Fittings are designed to give an expert finish to any home-constructed set; catalogue post free.—Belling and Lee, Ltd., Queensway Works, Ponders End, Middlesex. [0018]

WESTON Model 301, milliameters, ammeters, and voltmeters, 21/- each; hot wire ammeters, 0-1 amps., 4/-; 0-0.5 amp., 3/-; instrument repairs and alterations; send for list.—The Victoria Electrical Co., 47, High St., Battersea, S.W.11. Established 1910. [8626]

COMPONENTS Lent on Hire.—Details from Alexander Black, Wireless Doctor, 55, Ebury St., S.W.1. Sloane 1655. [0329]

IDEAL for Experimenters.—Dismantled components, condensers, valve holders, L.F. transformers, rheostats, etc.; 5/- per parcel; send to-day; carriage paid.—Hart Radio Supplies, East High St., Falkirk. [9260]

FERRANTI A.F.3 (two), 16/- each; British General, 5-1, 9/6.—87, Trafalgar Rd., Greenwich. [9272]

ELECTONE Automatic Time Switch Enables You to set your radio programme in advance, and ensures getting all the items you want, 24 hour clock; price 21/-.—Fredk. J. Gordon and Co., Ltd., 92, Charlotte St., W.1. [9283]

FERRANTI A.F.5, 20/-; O.P.M.1, 15/-; Varley R.C.C., 7/6, all guaranteed; Mazda H.L.210, new, 7/6.—Pratt, Exton, Topsham, Devon. [9285]

EXPERIMENTER'S Surplus for Sale.—Practically unused, transformers, Marconi all-power, model C, 220-30 volts, 20/-; R.I. straight line multi super, 17/-; Hyperma, 15/-; Marconi Ideal, 2.7-1, 15/-; ditto, 4-1, 15/-; chokes, R.I. dual astatic, 5/-; R.I. 28/14 henry, 15/-; Ferranti B3, 10/-; Mullard R.C. unit, 10/-; Cosmos with holder, 6/-; speaker units, Blue Spot 66K, 17/-; R.C., 6/-; Lissen super horn, 9/-; 2 Lissen 0.0005 log., variables, 4/- each; Cydon reaction 0.0003, 4/6; Cydon 0.0005 dual log., 10/-; 1've differential, 0.0003, 3/-.—Box 5882, c/o The Wireless World. [9295]

2-VALVE Amplifier, suitable for gramophone cabinet, containing Ferranti A.F.5 and Philips transformer, anti-motor boating device, with panel on which volume control, input and output jacks are mounted, no cabinet, L.F. and super power valves, bargain, £3/10; also Harlie pick-up and arm, 20/-; latest Marconi pick-up and arm, 40/-; ultra air-chrome speaker chassis, 35/-; Celestion speaker chassis, 35/-; 2 C.A.V. 30 amp. accumulators, 20/- new; Lissen 2-volt pentode, 7/6; Sifam moving coil milliammeter, 10/-; all above as new and genuine bargains.—A. S. Potter, 9, Bridge Rd., Uxbridge. [9286]

FERRANTI L.T. Charger, 30/-; Exide 6 volt 120 amp. accumulator, 20/-; valves, S.O.625, P.M.6D, D.E.L.610, L.S.5, D.E.5B, D.E.5, all 5/- each; D.E.5As, 7/6; S.G.610, 10/-; Matched L.S.5As, 12/6 each; all as new.—Harroway, 11, Bridge St., Stockport. [9287]

VARLEY, Ferranti, Blue Spot, B.T.H. parts, Amplion Lion oak speaker; half list; stamp list.—Side door, 43, Belsize Av., Hampstead. [9291]

FERRANTI A.F.5, 17/6; Ormond unit and chassis, 14/-; B.T.H. C2 loud-speaker, 25/-; Mullard P.M.24 valve, 15/-.—Crouchler, 13, Hawkesley Mill Lane, Northfield, Birmingham. [9302]

ONE Amplion Volume Control, cost 35/-, accept 20/-; 1 ditto Marconiphone, 5/-; Ideal transformer, 12/-; 1 Ferranti O.P.M.2C, 20/-; ditto A.F.5C, 24/- (both as new).—Stewart Dellefure, Grantown-on-Spey. [9312]



Why not-

Good valves are expensive—the exception is FOTOS. Everyone is marvelling at the price. They are cheaper and better than most good valves.

fotos

CONCERT VALVES

THE HEART OF EVERY SET

Trade Mark.

56
GENERAL PURPOSE AND POWER
7/6 SUPER POWER.

ask your dealer

or write for Descriptive Booklet B24.

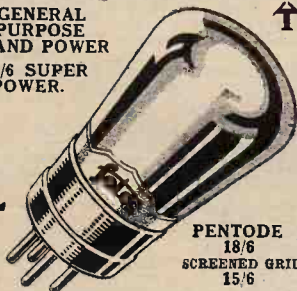

PENTODE
18/6
SCREENED GRID
15/6

CONCERTON RADIO & ELECTRICAL CO., LTD.,
256/7, Bank Chambers, 329, High Holborn, W.C.
Telephone: Holborn 8667

Aluminium Cabinets and Screening Boxes.

All sizes to order.

Standard screening boxes 6" x 6" x 6" 5/- each, including baseboards.

YATES SUTTON LTD., Sheet Metal Workers, York Street, Leicester.

MAKE A GRAMOPHONE AT



quarters shop prices. Or buy Cabinets, for Wireless. Order Set as shown—British spring motor. Velvet turn, table, swan arm, metal soundbox, amplifier, needle cups, for £1 17 8 h.p., and build your own Cabinet. Portable Gramophones from 19/6, postage 1/6. Motors from 8/6. Lists free. 64-pp. Catalogue, Drawing and How to Make Gramophones, 3d.

REGENT FITTINGS CO. (W.O.),
120, Old Street, London, E.C.1.

Components, Etc., For Sale.—Contd.

OSRAM Music Magnet, with valves, little used, perfect, £5/10; A.F.5, 18/-; Ormoid cone unit, with chassis, 15/6; Blue Spot 66K, with minor chassis, 22/-; I.M. cone speaker, 5-guinea model, 45/-; Bull-phone cone unit, 6/-; Philips 2-valve gramophone amplifier, 14/-; Lewcos triple coil unit, 35/-; pair Weston meters, in case, leads, plugs, d/r voltmeter 7.5/150, milli-ammeter 0/50, 35/-; Titian coil, Wearite, 8/6; Wearite leading coil, 4/-; Colvern dual, 8/6; Wearite Talisman, 4/-; set 4 Lissen S.G. coils, high and low, panel and baseboard given, 14/-; Harlie wave trap, 7/-; Watnuel tuner, 7/-; Igranic dual impedance L.F. unit, 10/-; L.S.6A, 17/6; P.M.24, 15/6; S4V, 15/-; A.C./S.G., 15/-; A.C./P, 10/6; A.C./H.L., 9/-; D.O./20, 17/6; all used few hours only, worth price asked; Philips 328 and 451 rectifier valves, retailers bankrupt stock, 7/-; G. A. Ryall, 182, Kennington Rd., London. [9273]

RADIO HOUSE, HUDDERSFIELD, issues the Reliability Wireless Guide, which will be sent post free upon request by Messrs. J. H. Taylor and Co., 15, Macaulay St., Huddersfield. [7823]

PART Exchange.—See our advertisement under Receivers for Sale.—Scientific Development Co., 57, Guildhall St., Preston. [0228]

RECORD Three Metal Cabinet, coils, decapped valve and switches, £3/10 lot, or exchange for A.C. moving coil speaker.—Briggs, 35, Heathall Av., Bradford, York. [9332]

IGRANIC Pick-up, 8/-; panel milliammeter, 5/-; Talisman coil, 4/6; Wates (3 in 1), 5/-; output transformer, 5/-—19b, Kingwood Rd., Fulham, S.W.6. [9321]

HYPERMU Transformer, 12/- P.M.254, 8/-; perfect.—Dougharty, 5, Becmead Av., Streatham, S.W.16. [9320]

TRANSFORMER, primary 200v., secondary 2,000v., centre tap and 10v., £2; 1 mid. oil condenser, 10/-; Weston galvanometer, £2.—Burnet, 16, Bunnerdale Rd., Sheffield. [9317]

DUAL Waveband High Frequency Chokes, excellent quality, money back guarantee; 2/9 each, post free.—Shaw, 526, New Chester Rd., Rock Ferry, Cheshire. [9336]

DUAL Coils, 250 to 2,000 metres, with switch, 9/-; H.F. chokes, 2/9 each.—Jordan, Chestnut Rd., Glenfield, Leicester. [9339]

A3 Westinghouse Rectifier, 16/-; A4 ditto, 30/-; electrolytic condenser, 10/-; Brown crystal amplifier, 25/-; Marconiphone A.C.5 all power unit, £8; two 10 mfd. condensers, £1; D.C. voltammeter, 5 ranges, 55/-; A.C. ditto, £3/5; Ediswan L.T. smoothing unit, 27/6; 6-volt M.C. speaker magnet, 10/-; old Weston 2-valve amplifier, £1; Lissen pick-up, 5/6.—Box 5895, c/o The Wireless World. [9342]

REGENTONE Portable A.C. Unit, £2/5; Woodroffe pick-up, £2; Gambrell Novotone, £2/10; all as new.—Box 5896, c/o The Wireless World. [9343]

ONE Set Orgola Coils, 12/6; 1 Radroix T.P.S.2 300-volt 50 ma., for U5 valve, 17/6; J.B. 0.0005 condenser, 2/6; Polar 0.0001, 2/6; Peto Soot 0.0001, 2/6; Varley power resistance, 40,000 ohms, in holder, 4/-; 3 P.M.5X, 5/- each; 1 P.M.6, 5/-; 2 P.625, 10/- each; 1 Lissen, 0.0002, 3/6; Varley resistance, 50,000, 2/6; 1 Burndept pick-up, 10/6; Limit tone arm, 10/6; 1 Centralab volume control, 500,000, 7/6; 1 Mullard R.C.C. unit, 5/-; 2 split primary, 250 to 550, 1/6 each; 2 neutralising condensers, 1/- each.—Box 0934, c/o The Wireless World. [9348]

ORMOND Cone Unit, as new, 8/-; valves, B.S.A. P612, Mullard P.M.5X, Marconi R5V, 3/- each.—Borwick, 618, Welbeck Rd., Newcastle-on-Tyne. [9351]

TWO R.K. Senior Loud-speakers, 6-volt field, unused, £5 each; 1 Igranic public address microphone, no front but in perfect order, £5/10; 1 pair field telephones, magneto ringings, new, £2/10.—Dominion Gramophone Records, Ltd., 55-7, Great Marlborough St., W.1. [9353]

BURNDIPT Needle Armature Pick-up, 30/-; P.M.24A., 15/-; P.M.S.4V., 12/6; D.E.P.410, 6/6; P.M.6, 6/-; all as new.—Box 5892, c/o The Wireless World. [9310]

PHILIPS Eliminator, 230 volt type 3009, £4/3; 4-volt transformer, 19/-; V unit and cone, 28/-; Permercore, 18/-; Lotus relay H.T. and L.T., 15/6; all as new.—G. Alderson, Dorridge, Birmingham. [9315]

MISCELLANEOUS.

ALEXANDER BLACK,

THE Original Wireless Doctor, will call (London and Home Counties) and cure your set.

CONSULTATIONS by Appointment Without Obligation, sets installed, maintained, and brought up to date, gramophone pick-ups, eliminators, and Webson moving coil speakers demonstrated; purity reproduction specialists.

55 Ebury St., Victoria, S.W.1: Sloane 1655. [0277]

“BAUGATZ” FIXED CONDENSERS.



As specified in “The Wireless World,” Feb. 12th, for “New Foreign Listener’s Four.”
1,500 volt D.C. tested.

1 μf. . . 2/- 2 μf. . . 3/- 4 μf. . . 5/3.

For your Set or Eliminator no better condensers are made than “BAUGATZ.” They cost no more than any good quality 500-volt ones, so why not have this extra margin of safety.

NEW!

700-volt D.C. tested NON-INDUCTIVE
Condensers in Bakelite Case.

1 μf. . . 2/- 2 μf. . . 3/- 4 μf. . . 4/3.

Delivery from Stock.

A. M. E. SHERWOOD,

66, Hatton Garden, London, E.C.1.

Phone: Holborn 1280.

EPOCH MOVING COIL SPEAKERS

The Greatest Success in Wireless to-day.

While other manufacturers have slowed or closed down completely for the season, Epoch is still working 16 hours per day to cope with the avalanche of orders.



There is a sound reason for this phenomenal success!

Further increase in production now enables deliveries to be made within 7 days of order.

Call for a demonstration or send for Booklet W.S.3.

Epoch Radio Manufacturing Co. Ltd.,
Farringdon Avenue, E.C.4.

Mention of “The Wireless World,” when writing to advertisers, will ensure prompt attention.

Miscellaneous.—Contd.

CALIBRATE Your Set With the C.D.E.S. Calibration Chart; 8d., post free.—C.D.E.S., 98, Cherry Orchard Rd., Croydon. [8612]

SCOTT SESSIONS and Co., Great Britain's Radio doctors, officially approved as wireless repairers by Radio Society of Great Britain and Wireless League; old sets of every type repaired, rebuilt, modernised; send set for immediate quotation.

SCOTT SESSIONS and Co.—New sets constructed with your or our components, guaranteed finest workmanship; we specialise in "The Wireless World" circuits; remember, we have satisfied customers throughout the British Isles and in three Continents; if you so desire, we will design and construct high grade apparatus to suit your special circumstances for quality, range and selectivity.—Tel.: Tudor 5326. Muswell Hill, London, N.10. [0262]

EASY Payments.—We supply, by easy payments, components, accessories, and sets, any make; 10% down, balance spread over 11 months.—Send list of requirements to London Radio Supply Co., 11, Oat Lane, London, E.C.2. [0337]

UNIFORM (wireless operator's), almost new, perfect condition; jacket, cap and trousers; cost £10/10, sell £4; size on application.—F. Glide, Busling, Isle Brewers, Taunton. [9269]

ENGINEERS.—Novice or expert; £300, £400, £500 per year or more is within your grasp. In our handbook "Engineering Opportunities," Prof. A. M. Low explains where the good posts abound. This handbook has shown the way to better things to over 20,000 of your fellows. It contains details of A.M.I.Mech.E., A.M.I.E.E., A.M.I.C.E., A.M.I.A.E., A.M.I.Struct.E., A.M.I.E.E., C. and G., G.P.O., etc., Exams., outlines home study courses in all branches of electrical, mechanical, motor and wireless engineering, and shows the unique advantages of our appointments department. Why stay in the Hammer and File Brigade? Send for our free handbook at once, stating branch, post or exam. which interests you.—British Institute of Engineering Technology, 87, Shakespeare House, 29-31, Oxford St., London, W.1. [9280]

PANELS Engraved, 1/2, per letter; terms to trade.—G. Griffith, 12, February St., C. on M., Manchester. [9346]

600 Copies Various Wireless Papers and Gramophone Radio Kit Going Cheap; lists.—Pepper, Wake Green Rd., Birmingham. [9345]

PATENT AGENTS.

PATENTS and Trade Marks, British and foreign.—Gee and Co. (H. T. P. Gee, Member R.S.G.B. and A.M.I.R.E.), 51-52, Chancery Lane, London, W.C.2. Phone: Holborn 1525. [0001]

REPAIRS.

SCOTT SESSIONS and Co., Great Britain's radio doctors; read advertisement under Miscellaneous column. [0263]

GUARANTEED Repairs by Experts.—Loud-speakers, headphones, cone units, pick-ups, any type, re-wound, remagnetised, and adjusted, post free 4/-; transformers, from 4/-.—Howell, 91, Morley Hill, Enfield, Middlesex. [7882]

REPAIRS Returned Post Free, and to ensure satisfaction send remittance after approval of same.—Leeds Wireless Repair Service.

LOUD-SPEAKERS, headphones, re-wound to any resistance and remagnetised, 3/-; transformers re-wound, 4/-; Blue Spots, Triotrons and 4-pole units, 4/6; work guaranteed.—Leeds Wireless Repair Service, 5, Boston Place, Green Rd., Leeds. [9329]

WANTED.

WANTED, all types of electrical and wireless apparatus; purchased for cash; large quantities only.—Thompsons, 1, South St., Greenwich, S.E.10. Tel.: 1259 Greenwich. [0331]

H.T.1 and **G.B.I.** Rectifiers and Ferranti 2mid. Condensers.—Moon, Linden Av., Darlington. [9259]

RADIOGRAM Cabinet, S.G. coils, D.S. motor, pick-up arm.—Box 5886, c/o The Wireless World. [9296]

WANTED, H.T. eliminator for D.C. 200-250 volts mains.—Simpson, Fairrigg, Arnsby, Carnforth. [9335]

WANTED, 6-1 Ideal transformer, Ferranti horn speaker.—14, Goldsmith Rd., Acton, W.3. [9338]

EXCHANGE.

3A Kodak, in case, originally cost £8, for pick-up and Garrard motor, complete.—Graysmark, 38, Bengal Rd., Ilford. [9276]

Exchange.—Contd.

COMPONENTS Taken in Part Payment, brand new supplied guaranteed; any reasonable suggestion accepted; cash payment not always essential; state lowest price acceptable for your goods, and particulars of new required.—Ryall's Radio, 182, Kennington Rd., London. [9261]

EXCHANGE 3-valve Efescaphone, in grand roll front mahogany cabinet, for permanent magnet or ultra loud-speaker, good order, no valves or batteries.—Lyndhurst, Walrod Av., Wembley. [9299]

WE Will Accept Your Surplus Apparatus (making you a high allowance) in Part Payment for any New Apparatus; your enquiry will be dealt with promptly.—Postock and Stonnill, 1, Westbourne Terrace, S.E.23. [9303]

PART Exchange as it Should Be, perfected after months of enquiry as to way and means, the only perfect system, best offers only made, no junk accepted.—The Leading Part Exchange Specialists, the Northfield Radio Stores, 157, Northfield Av., Ealing, W.13. [9322]

GECOPHONE Superhet Kit, exchange Bowyer-Loewe or wireless parts; send list.—Way, 57, High St., Mountain Ash [9330]

FINANCIAL PARTNERSHIPS.

WIRELESS Component Manufacturing Firm, established over three years, and supplying the trade under a registered trade mark, requires capital for development, would entertain partnership, factory in London district.—Box 5893, c/o The Wireless World. [9340]

SITUATIONS VACANT.

WANTED, demonstrators for portable sets.—Box 5787, c/o The Wireless World. [9222]

AMATEUR Constructors Wanted as Agents in A.C. Districts for Eliminator Kits, etc.—Details from Fel-Ectric Radio, 56, Garden St., Sheffield. [925F]

WIRELESS Services.—The Premier Telegraph College in the British Isles (established 34 years) gives a sound training to all students, with assured positions on qualification. Fees are not disguised under expensive board-residence scheme. 4 students out of a total of 47 obtained qualifying wireless certificates at first attempt in the last seven Government examinations.—Apply for prospectus, Dept W, The London Telegraph Training College, Ltd, Morse House, Earl's Court, S.W.5. [926]

SITUATIONS WANTED.

JAD, age 19, seeks good situation; full all round knowledge and practice of pianos, player-pianos, gramophones and radio.—Box 5809, c/o The Wireless World. [9267]

MAN with Six Years' Experience in Wireless and Sound Reproduction, holding 1st class P.M.G. certificate, experienced in set and amplifier design, keen and energetic worker, requires progressive post with wireless or talkie firm; has real testimonials and references; young and go-ahead.—Box 5818, c/o The Wireless World. [9270]

YOUNG Man Wishes to Join Firm of Wholesale Wireless Factors, own car and connection; moderate salary and commission.—Box 5887, c/o The Wireless World. [9297]

EX Naval Operator (30), 14 years' experience good theoretical and technical knowledge, Grade 1 certificate City and Guilds Radio Communication desires progressive appointment with radio, gramophone, or talking picture firm.—Box 5904, c/o The Wireless World. [9347]

BOOKS, INSTRUCTION, ETC.

STEP by Step Wireless; a complete course of the theory of electricity in relation to the practical design of wireless apparatus, eliminators, circuits, etc., with extracts from a designer's notebook, giving up-to-date practical application; issued weekly, send 1/- p.o. for first 4 weeks.—Clifford Pressland, A.M.I.E.E.Eng., Dept. W.W., Hampton-on-Thames. [0195]

FREE: Inventor's Guide on Patents.—T. A. A., 253 (W), Gray's Inn Rd., London, W.C.1. [6373]

CASH Offers.—"Wireless World" from December, 1921, to date.—Herd, Egremond, Cumberland. [9292]

TELEVISION.—The complete authorised book on television (Baird Experimental) transmission and receiving, is now ready; order "Television Today and Tomorrow" (Moseley and Barton Chaplin), 7/6 net.—Pitman's, Parker St., Kingsway, W.C.2. [9308]

NEW PUBLIC ADDRESS and Broadcasting MICROPHONES

The Ideal Instruments for addressing an Audience through Loudspeaker (via Valve Amplifier or L.F. Stages of Wireless Set), and for relaying Speech and Musical Entertainment to any distance. Powerful Loudspeaker Reproduction with perfect Purity.

Hand Type, highly distance-sensitive, yet guaranteed entirely free from distortion or microphonic noises, absolutely silent background; far superior to ordinary Microphone Transmitters; for use with Valve Amplifier or Valve Set (through leads of Gramophone Pick-up if desired) at Open-air Meetings, in Cinema, Theatre, or Concert Hall. Operates from 2 Volt tapping of L.T. Accumulator, through Microphone Transformer. Current consumption one-tenth Ampere. Provided with detachable Sound Collector, handle, hook for suspension, and a 9ft. silk connecting cord as illustration. **16/6**

Pedestal Type Highly Sensitive Microphones as above described, provided with detachable sound collector and a 9ft. silk connecting cord, but fixed by rubber-cord suspension in nickel-plated frame on pedestal 11in. high; for mounting on Speaker's Platform, in Pulpit, on top of Camera Stand, or for suspension from ceiling, as illustration. **25/-**

The above Microphones are rendered Directional by attaching the Sound Collector.

Microphone Transformer, special design to obtain best possible results from sensitive Microphones when connected to high-resistance phones, Loud Speaker, Valve Set, or Valve Amplifier; best Transformer made for clear speech with volume, modulation speech and music transmission, Public Address Microphones, etc. Primary and Secondary terminals fitted; full directions for use of Microphone and diagrams of connections free. Goals by return post. **6/-**

FREDK. ADOLPH, Actual Maker, 27, Fitzroy Street, London, W.1. PHONE: Museum 8329

POPULAR TRANSFORMER

The Brownie POPULAR Transformer is every bit as good as it looks. Its purity of amplification gives vivid clarity throughout the full musical range, while its sturdy British construction ensures that it will give this quality of reproduction not just now and then, but always. It costs only 9/6, and does the work of transformers at double its price.

BROWNIE WIRELESS CO. (G.B.) LTD. Nelson Street Works, London, N.W.1

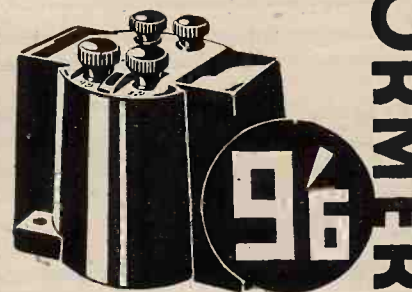

BROWNIE WIRELESS

INDEX TO ADVERTISEMENTS.

Adolph, Fredk.	PAGE 15
Appleby, E. Hetherington	10
B. & J. Wireless Co.	10
Baker's "Selhurst" Radio	13
Belling & Lee, Ltd.	10
Benjamin Electric, Ltd.	15
Brownie Wireless Co. (G.B.), Ltd.	15
Burne-Jones & Co., Ltd. (Magham)	4
Carlington Manuf. Co., Ltd.	5
Celestion, Ltd.	5
Cole, E. K., Ltd.	Cover i.
Concerton Radio & Electrical Co., Ltd.	14
Digby, F.	10
Edison Swan Electric Co., Ltd.	6 & 7
Electradix Radios	12
Epoch Radio Manf. Co., Ltd.	14
Ever Ready Co. (G.B.), Ltd.	Cover iv.
Exact Manf. Co.	12
Exide	4
Fonteyn & Co.	16
Gambrell Radio, Ltd.	

Garnett, Whiteley & Co., Ltd.	PAGE 11
General Electric Co., Ltd.	1
Hayward, F. C., & Co.	4
Holzman, E.	Cover i.
Hughes, F. A., & Co., Ltd.	Cover i.
Ideas Development Syndicate, Ltd.	12
Jackson Bros.	8
Lever, Eric J. (Trix), Ltd.	8
London Electric Wire Co. & Smiths, Ltd.	Cover iii.
Marconiphone Co., Ltd.	9
McMichael, L., Ltd.	8
M-L Magneto Synd., Ltd.	8
Mullard Wireless Service Co., Ltd.	Cover i.
Overseas Trading Co.	12
Partridge & Mee, Ltd.	Cover iii.
Paroush, E.	16
Perseus Manf. Co.	Cover ii.
Pertrix, Ltd.	8
Phillips Lamps, Ltd.	4
Potter, H. B., & Co., Ltd.	4

Premier Supply Stores	PAGE 16
Radiogramophone Development Co.	16
Regent Fittings Co.	14
Regent Radio Supply Co.	5
Rigby & Woolfenden	16
Rotor Electric, Ltd.	12
Rowley Bros., Ltd.	16
Scientific Supply Stores	14
Sherwood, A. M. E.	5 & 6
Telegraph Condenser Co., Ltd.	16
Thomas, Bertram	16
Transformer Repair Co.	16
Turnock's Mouldings	3
Vandervell, C. A., & Co., Ltd.	12
Varley (Oliver Pell Control, Ltd.)	3
Westinghouse Brake & Saxby Signal Co., Ltd.	12
Wilburn & Co.	16
Wilkins & Wright, Ltd.	16
Wingrove & Rogers, Ltd.	Cover iii.
Wright & Weaire, Ltd.	14
Yates Sutton, Ltd.	14

Half price!
CROSSLEY
5-Valve PORTABLES
 Original Price £15.15.0
£7.15.0 Makers' Guarantee
 12 months.
 All components of
 best quality. Un-
 spillable accumulator.
 National Loud-
 speaker. Tungstram
 Valves.
 A first-class set giving
 first-class results.
PREMIER SUPPLY STORES,
 165, Fleet Street, London, E.C.4

BONA FIDE TRADERS' GUIDE.
 Send for our comprehensive Illustrated List.
QUICK SERVICE. QUICK SERVICE.
THE QUALITY HOUSE.
PERSEUS MFG. CO., LTD. (Dept. W.W.),
BRANSTONE RD., BURTON-ON-TRENT.

BECAUSE
 of their precision in design and
 construction, you secure with
 Polar a high degree of
 efficiency combined with
 lasting service.
 Write for Free Catalogue.
WINGROVE & ROGERS LTD.
 188-9, Strand, London, W.C.2.



POLAR

Electrically sealed
METAL CABINETS
 Complete with Base for 1930 Everyman
 Four, New Kilomag Four, and W.W.
 Record III. Jacobean Finish.
TERMS: CASH WITH ORDER Price 57/6.
RIGBY & WOOLFENDEN, SHEET METAL
 WORKERS,
 MILNROW RD., ROCHDALE.

"TILTRACK"
 Registered Trade Mark
 Patent-STEEL STORES-System
 For the Wireless Experimenter, Factory,
 Factor and Retailer,
 Full Particulars from Sole Manufacturer and Patentees:-
BERTRAM THOMAS, Worsley Street, Hulme,
 MANCHESTER.

POWER CHOKES guaranteed
 twelve months
 substantially built, for smoothing circuits
 in eliminators dealing with currents
 100 to 300 milliamperes,
 inductance 30 henries,
 post free.
8/6
REPAIRS
 to any make
 of L.F. Transformer,
 Loudspeaker or Headphones.
 All repairs dispatched within
48 HOURS - TWELVE MONTHS' GUARANTEE
 with each repair. 4/- Post Free. Terms to Trade
TRANSFORMER REPAIR CO.
 Dept. W.,
 214, High Street, Colliers Wood, London, S.W.19.

From a recent
 advertiser's
 letter:
**"I must say your
 paper is a good ad-
 vertising agency."**
C. R. PEARCE,
 St. Germans,
 Cornwall.
 W.W.46

C.F. Radio Controller
 finds faults in your set
 Write for Illustrated Leaflet to
FONTEYN & CO. LTD.
 2 to 6, Blandford Mews, Baker St., W.1

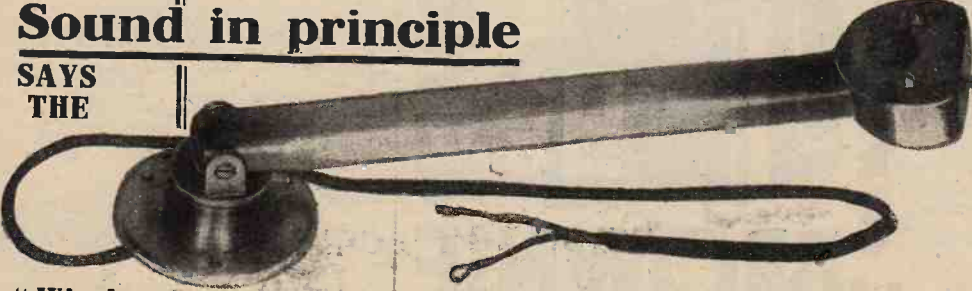
Sound in principle
SAYS THE

"Wireless World."
THE R.G.D. PICK-UP
 is free from resonance.
 No tracking wear. Highly
 finished Pick-up in
 Bronze, Oxidised Silver.
 Specially constructed for
 the Coil-driven Speaker.
 Price
£2:10:0
 Post free.
THE RADIOGRAMOPHONE DEVELOPMENT CO.,
 ST. PETER'S PLACE, BROAD STREET, BIRMINGHAM.

Mention of "The Wireless World," when writing to advertisers, will ensure prompt attention.

REJECT INTERFERENCE !

**Local Stations Eliminated.
Distant Transmissions Separated
with the Lewcos Rejector Wavetrap.**

This component, the latest development of the Lewcos laboratories, can either be inserted in series with the aerial lead-in wire and employed as an ordinary Rejector Wavetrap, or where unscreened radiating coils such as standard six-pin or "Q" Coils are employed it may be used as an absorption wavetrap. When used in

the latter manner no connections are necessary.

Where extreme conditions necessitate it, a Rejector Wavetrap can be used in conjunction with an absorption wavetrap and may be used with either crystal or valve set.

For further details write for leaflet R.60.

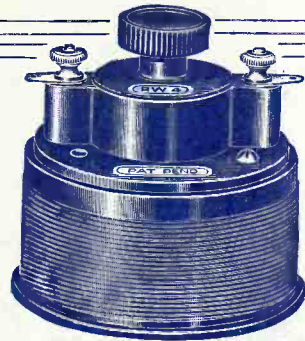

Rejector Wavetrap.
RW. 4, 235-425 metres.
Price 7/6 each.
Absorption Wavetrap.
AW. 5, 235-550 metres.
AW. 20, 1000-2000 metres.
Price 6/- each.

LEWCOS

REGD.

**THE LONDON ELECTRIC WIRE
COMPANY AND SMITHS LTD.,**
Church Road, Leyton, London, E.10.

Trade Counter:
7, Playhouse Yd., Golden Lane, E.C.1.

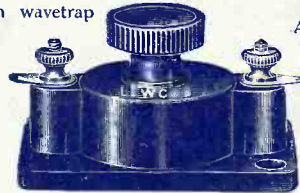

LEWCODENSER.

Type "O" — capacity '00015 to '001 mfd.
2/6 each.

Type "W" — capacity '00002 to '0002 mfd.
2/6 each.



*Haven't they got
what you want?*

PARMEKO

can make it

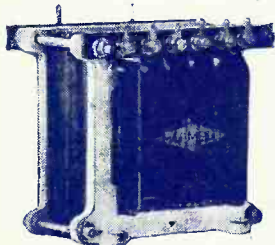

Write for Price List of
Wireless Mains Apparatus.

The manufacturers of PARMEKO apparatus recognise that occasionally the serious amateur needs a component which he cannot get from stock. If this is your case, send particulars of your requirements and we will quote by return. There are PARMEKO Chokes and Transformers for all circuits published in the technical press. The high quality of PARMEKO products is evident to all who use them.

PARTRIDGE & MEE Ltd.,

26, DOVER STREET,
LEICESTER

74, New Oxford Street,
LONDON, W.C.1

GUARANTEED

WEARITE

COMPONENTS

**MAINS TRANSFORMERS AND L.F. CHOKES
FOR ALL PURPOSES.**

Send us your enquiries.

Type	Output.		Use.	Price.
T.1	4 v	5 a	For Heaters of A.C. Valves For H.T. & L.F.	25/-
T.2	4 v	5 a		
	5.5 v	2 a	For A.C. Valves Also U.5 Type Rectifier	37/6
	250 v	80 m/a		
T.3	135 v	£0 m/a	For Westinghouse Rectifiers Styles H.T.3 & H.T.4	27/6
T.4	135 v	50 m/a	As T.3 with addition of wind- ings for A.C. Valve Heater	32/6
	4 v	5 a		
T.5	230 v	50 m/a	For Westinghouse Rectifier Style H.T.1, also A.C. Valve Heater Winding	32/6
	4 v	5 a		
CONSTANT INDUCTANCE L.F. CHOKES.				
	Inductance (Henries)	Resistance (Ohms)	Current-carrying capacity.	
H.T.2	20	350	75 m/a	21/-
H.T.3	40	850	50 m/a	21/-
H.T.5	20	400	30	12/6
H.T.6	60	2500	15	15/-

Write for free illustrated lists:

WRIGHT & WEIRE LTD.,
740, HIGH ROAD, LONDON, N.17. Phone: Tottenham 3847/8.

Advertisements for "The Wireless World" are only accepted from firms we believe to be thoroughly reliable.



**I'm the most Powerful—
most Silent—
Challenge me if you will**

For 6 m.a. discharge:
 "WINNER" Series, 60 volts - 7/-
 "POPULAR" Series, 60 volts - 9/6
 For 10-16 m.a. discharge:
 "POPULAR" POWER Series,
 60 volts, 13/6
 For 20-30 m.a. discharge:
 HIGH POWER SIXTY, 60 volts, 15/6

I'm



Send for List of Standard Sizes suitable for every set.
THE EVER READY CO. (G.B.) LTD., Hercules Place, Holloway, N.7.

Printed for the Publishers, ILIFFE & SONS LTD., Dorset House, Tudor Street, London, E.C.4, by The Cornwall Press Ltd., Paris Garden, Stamford Street, London, S.E.1.

Colonial and Foreign Agents:
 UNITED STATES—The International News Co., 351, Varick Street, New York. FRANCE—W. H. Smith & Son, 248, Rue Rivoli, Paris; Hachette et Cie, Rue Réaumur, Paris.
 BELGIUM—W. H. Smith & Son, 78, Marche aux Herbes, Brussels. INDIA—A. B. Wheeler & Co., Bombay, Allahabad and Calcutta. SOUTH AFRICA—Central News Agency, Ltd.
 AUSTRALIA—Gordon & Gotch, Ltd., Melbourne (Victoria), Sydney (N.S.W.), Brisbane (Queensland), Adelaide (S.A.), Perth (W.A.), and Launceston (Tasmania).
 CANADA—The American News Co., Ltd., Toronto, Winnipeg, Vancouver, Montreal, Ottawa, St. John, Halifax, Hamilton; Gordon & Gotch, Ltd., Toronto; Imperial News Co., Toronto, Montreal, Winnipeg, Vancouver, Victoria. NEW ZEALAND—Gordon & Gotch, Ltd., Wellington, Auckland, Christchurch and Dunedin.

BUILDING THE POWER PENTODE-TWO.

The Wireless World

AND RADIO REVIEW

The Paper for Every Wireless Amateur

Wednesday, May 14th, 1930.

4^D

BurTON

SELF-LOCATING

VALVE
HOLDER

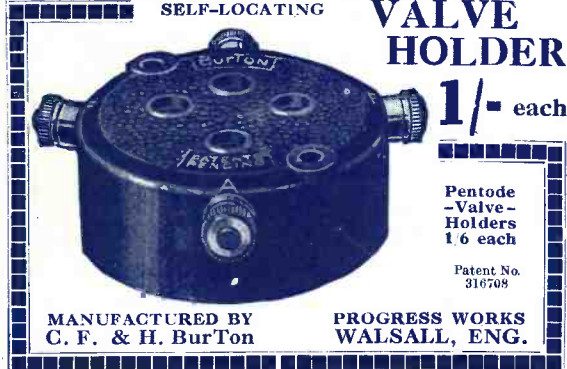

1/- each

Pentode
-Valve-
Holders
1'6 each

Patent No.
316705

MANUFACTURED BY
C. F. & H. BurTON

PROGRESS WORKS
WALSALL, ENG.



TELSEN
L.F. TRANSFORMERS

Radio's Choice

Have acquired a world-wide reputation for Quality and Value. Built by Specialists in Transformer construction they have set a Quality of Performance above reproach. Your Set will work better with a Telsen Transformer Try one now!

Radiogram 15-0
Ratio 3-1 & 5-1
Radiogram 7-1
Ratio Price 17/6.

TELSEN ELECTRIC
CO. LTD., Miller St.,
Birmingham.

VIVIDLY NATURAL RADIO WITH THIS SUPREME SPEAKER

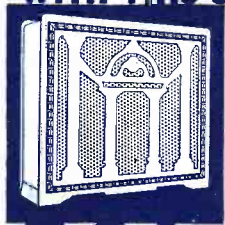

If your set is old or new, large or small, the Ultra Air Chrome Speaker will give you radio with atmosphere, character, temperament and vitality. Vividly natural, playing, singing or talking, with perfect acoustic balance over the full compass of orchestra and voice. From all dealers.

50%
OFF

ULTRA
AIR CHROME SPEAKER

WITH THE DOUBLE LINEN DIAPHRAGM

ULTRA ELECTRIC LIMITED, 661, HARROW ROAD, LONDON, N.W.13

McMICHAEL PORTABLE RECEIVER

22 GNS.

Point No. 5.

CONTROL.

The seven technical conditions fulfilled by this Receiver have been harnessed to Controls which make tuning and control delightfully easy and certain.

Hear it at any high-class radio store or our London showrooms.

L. McMICHAEL LTD.,
Wexham Road, Slough, Bucks.
179, Strand, London, W.C.2.



PHILIPS

BATTERY ELIMINATORS (H.T. UNITS)

Get the *best* out of your receiver—volume, tone quality, distance—by using a Philips Battery Eliminator and thus taking your H.T. current from the electric mains. Also it's *cheaper* than having to pay for new batteries every now and then. One of the three types of Philips Battery Eliminators meets your needs. Types 3009 and 3002 work off A.C. Mains, Type 3009 giving grid bias as well as H.T. For D.C. Mains there is Type 3005.

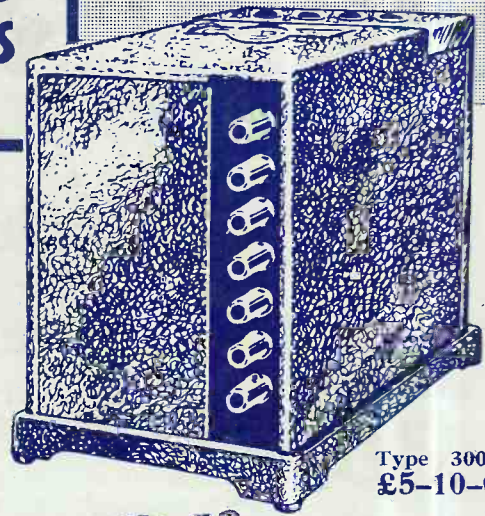

Type 3002
£5-10-0

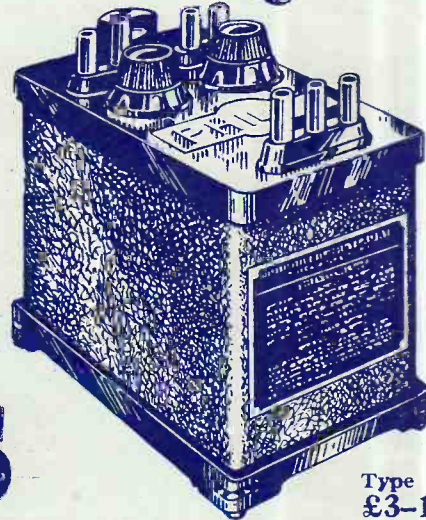

Type 3005
£3-17-6

PHILIPS

ALL-ELECTRIC RADIO

Made by the manufacturers of the famous Philips all-electric radio receivers and Argenta electric lamps, commercial and industrial fittings, and neon signs.

For 10/- down you can have any of these on Philips' Easy Payment System.

Type 3009
£5-15-0

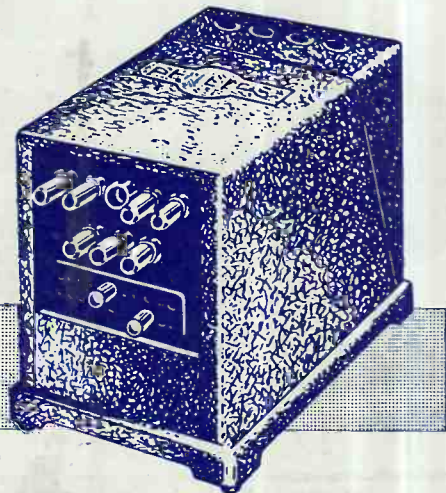

PHILIPS LAMPS LTD., PHILIPS HOUSE, 145, CHARING CROSS ROAD, LONDON, W.C.2.

Mention of "The Wireless World," when writing to advertisers, will ensure prompt attention.



The New

2-Volt SUPER POWER VALVE

built like a 6volt 'Super'.

OSRAM P.2

The latest addition to the Famous range of OSRAM Super Power Valves

Note these Characteristics:

- Filament Volts.....2.0 max.
- Filament Current.....**0.2 amps.**
- Anode Volts.....150 max.
- Amp. Factor.....**6.5**
- Impedance **2,300 ohms.**
- Mutual Conductance.....2.8

SUPER POWER

Osram Valves

MADE IN ENGLAND

Sold by all Wireless Dealers

FOR ECONOMICAL WIRELESS



LOW filament current means economy in L.T. consumption.

LOW Impedance and an Amplification factor of 6.5 means a large undistorted output without loss of range.

Specially suitable for portable sets where the volume and tone of a super power valve is required with a minimum supply of H.T. current.

Advert. of the General Electric Co., Ltd., Magnet House, Kingsway, London, W.C.2.

A Advertisements for "The Wireless World" are only accepted from firms we believe to be thoroughly reliable.

IGRANIC COMPONENTS

KNOWN FOR QUALITY and PRECISION

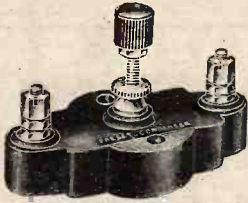

IGRANIC PRE-SET CONDENSERS
Price from 2/-

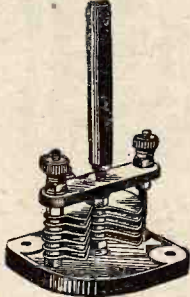

IGRANIC
Baseboard Type MICRO CONDENSER
Price 4/-

IGRANIC RADIO DEVICES

are not manufactured by a mushroom firm down some back alley, but are manufactured by a firm having 30 years' experience in the manufacture of electric devices, with a Works occupying approximately six acres of ground, equipped with the latest up-to-date plant. Behind every Radio Component stands a reputation that has to be maintained.

Write to Dept. U313 for literature showing the whole range of Igranic Components.

**Use IGRANIC COMPONENTS
and be more than satisfied.**



Works BEDFORD

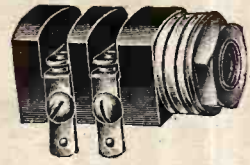

IGRANIC
MIDGET JACKS. Ideal for Portables.
Price from 1/4



IGRANIC
"J" Type L.F. TRANSFORMERS
Price 17/6

RADIO DATA CHARTS

A SERIES OF ABACS

providing most of the essential Data required in Receiver Design.

By R. T. BEATTY, M.A., B.E., D.Sc.

Reprinted from "The Wireless World."

"Radio Data Charts" provide designers of wireless apparatus with a ready and convenient means of solving problems without having recourse to complicated formulæ and mathematics.

By the use of the charts it is possible to tackle all the more familiar problems in radio receiver design; such as, for example, finding the relationship between inductance capacity and frequency, and working out the design of high frequency transformers. All keen amateurs will appreciate this helpful book.

Price 4/6 net. By post 4/10.

(39 CHARTS and more than 50 Diagrams.)

From all leading booksellers or direct from the Publishers.

Published from the Offices of "THE WIRELESS WORLD."

ILIFFE & SONS LTD., Dorset House, Tudor St., London, E.C.4.

Mention of "The Wireless World," when writing to advertisers, will ensure prompt attention.

MULLARD SPECIFY VARLEY

for the New "Radio for the Million."



Specified in most popular circuits, Varley are again in "Radio for the Million!" These are the Varley components required for the Orgola High Power H.T. supply unit:

STANDARD L.F. CHOKE
Price

£1 : 0 : 0

DUAL L.F. CHOKE
Price

£1 : 1 : 0

POWER POTENTIOMETERS
50,000 ohms. 10,000 ohms.
Price Price

10'6 10'-

Make sure you get these Mullard-recommended components for your Orgola H.T. Supply Unit.

Send for the sections of this Varley Catalogue in which you are interested.

SECTION A. 2- and 3- valve All-Electric Receivers, Radio-Gramophones, Gramophone Pick-up and Auto-arm.

SECTION B & C. H.F. Choke, Regional Coils, Bi-duplex Resistances, Rheostats, Potentiometer, R.C. Couplers and Anti-Mobos.

SECTION D. Nicore Transformers, Output, Push-Pull Input and Output Transformers, Push-Pull, L.F. and Constant Inductance Chokes.

SECTION E. Power Transformers, Standard, Dual and L.T. L.F. Chokes, Constant Inductance Chokes and Power Potentiometers.



Advertisement of Oliver Pell Control, Ltd., Kingsway House, 105, Kingsway, London, W.C.2. Telephone: Holborn 5303.

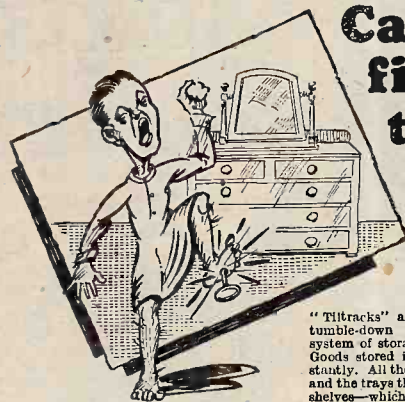

Can You find things Easily?

Joking apart—as a Wireless Experimenter or as a Business Man you cannot afford to waste time, temper and money in aimless searching for components you need.

"Tiltracks" are a big advance on dark and tumble-down wooden shelves—or any other system of storage.

Goods stored in "Tiltracks" can be found instantly. All the trays have adjustable partitions, and the trays themselves can be lifted from the shelves—which is a big help at stocktaking time.

Please write for Lists.

THERE ARE MANY STYLES OF "TILTRACKS."

THE "BENCHRACK" (Tiltrack Principle)

A real help for storing small parts such as Terminals, Nuts, Washers, Insulators, etc. Made to stand on the work bench, it enables all small parts needed for the job in progress to be stored where they are immediately to hand. All the trays are tilted so that the parts stored can be seen at a glance, and the front faces of the trays are rounded so that the smallest parts can be swept up the slope with the fingers of one hand. Each tray is provided with patent hinging partitions which can be moved quickly to make larger or smaller compartments. Being so accessible these racks greatly facilitate stocktaking and being all steel there is no danger of fire. The Experimenter will do his jobs much quicker and with greater pleasure, and the Factory will save many pounds per year by installing this Benchrack.

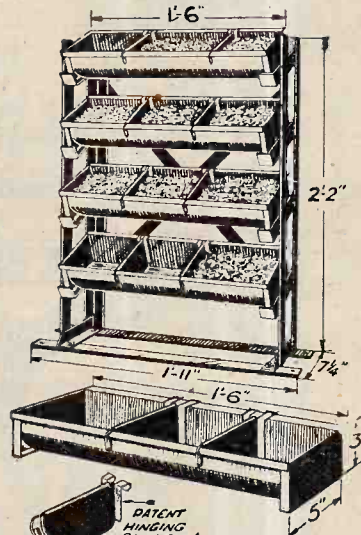

30' - F.O.R.



"TILTRACK JUNIOR"

This all-steel rack is designed to hang against a wall or other convenient position, and is a most excellent rack for storing small parts. It is supplied complete with white canvas protective cover to keep out the dust. All the trays are tilted and have movable partitions.

30' - POST FREE.

THERE ARE MANY MORE STYLES OF "TILTRACKS." PLEASE SEND FOR LISTS.

Particulars from Manufacturer & Patentee — **BERTRAM THOMAS,** Worsley Street, Hulme, MANCHESTER. London Office & Showroom — 28, Victoria Street, S.W.1.

Weston sets the world's standard



Model 528, Pocket Size A.C. Tester

A small and reliable instrument essential to maintain accuracy and efficiency in Voltage control. The sensitivity is remarkably high, 6 m.a. for 600 volts with self-contained resistance. The Scale is very legible and the damping excellent. This instrument is capable of continuous service at full load.

Prices from **£3. 10. 0 to £4. 15. 0**

WESTON
ELECTRICAL INSTRUMENT CO., LTD.

15, Great Saffron Hill, London, E.C.1

Write for your copy of "Radio Control," which explains simply the electrical operation of a radio set. Sent free on receipt of a postcard addressed to:—

Utility

GUARANTEED SWITCHES

Give your set a fair chance of showing what it can do by including "Utility" Switches. If you buy a complete kit or an assembled set, insist that the components are "Utility." New Illustrated List includes this small anti-capacity Switch—write for a free copy.

WILKINS & WRIGHT LTD.,
UTILITY WORKS, HOLYHEAD ROAD, BIRMINGHAM.

Prices of the Switch illustrated:

1 pole change over	4/6
2 " " "	5/-
3 " " "	6/-
4 " " "	7/6
5 " " "	9/6
6 " " "	9/6

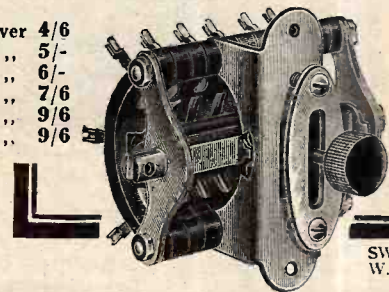

SWITCH W. 190.

MAKERS of MAINS SETS!...

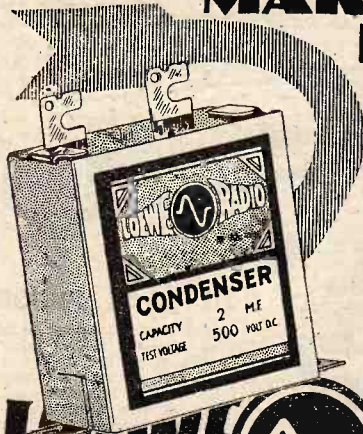

Wireless amateurs and others who are making mains sets and Eliminators will want these new LOEWE RADIO Paper Condensers. Sturdily constructed, they can be relied upon to maintain a consistently high performance. Write for full details. Also supplied with screw terminals and soldering tags.

LOEWE RADIO

Retail Price From

1/2
EACH

Paper IN METAL CASES CONDENSERS

Made in a complete range of values. For example:
 .1 m.f. tested to 500 v. D.C. 1/2 each. } Retail Prices
 " " 700 v. D.C. 1/3 each. }
 " " 1000 v. D.C. 1/4 each. }
 " " 1500 v. D.C. 2/1 each. }

Complete range and prices on request.
SPECIAL NETT PRICES TO MANUFACTURERS.

THE LOEWE RADIO COMPANY, LIMITED.
4, Fountayne Road, Tottenham, N.15. Phone: Tottenham 3911/2.

HERE IS THE RADIO - GRAMOPHONE CABINET YOU ARE LOOKING FOR.

INSTALL A "LANGMORE"

and have your Gramophone, Wireless Set, Loud-speaker and Batteries all in one Cabinet. These Cabinets are 3 ft. 2 ins. high x 21 ins. wide x 15 ins. deep overall, and are very strongly constructed of selected Oak and Plywood.

THE TOP SECTION. Size 4 1/2 ins. high x 18 ins. wide x 13 1/2 ins. deep, gives ample accommodation for Gramophone and Pick-up.

THE CENTRE SECTION. Size 10 ins. high x 18 ins. wide x 14 ins. deep, is for the Wireless Set, to take a panel either 18 ins. x 7 ins. or 18 ins. x 8 ins.

THE BOTTOM SECTION. Size 15 ins. high x 18 ins. wide x 13 1/2 ins. deep, gives accommodation for Loud-speaker and Batteries.

The whole of the back is enclosed by double doors, so that all parts are easily accessible. ALL are fitted with Hinged Top, Heavy Baseboard, etc.

BEAUTIFULLY FINISHED JACOBEOAN OAK.



Price 49/6 Each.

Packed FREE and sent Carriage Paid to any address in Gt. Britain. Trade Enquiries Invited.

THE MISCELLANEOUS TRADING Co., Ltd.,
13 & 17, NEW OXFORD ST., LONDON, W.C.1

Phone: HOLBORN 4894.

Smooth Flowing POWER



Like a deep, smoothly flowing stream the volume control on your radio if it is a **CENTRALAB** delivers a constant, uninterrupted flow of power that results in the purest, finest tone.

Write for the Centralab circuit booklet. It's free.

The world's most famous radio sets are Centralab equipped. Is yours?

Centralab

THE ROTHERMEL CORPORATION LTD.
24 Maddox Street, London, W.1.
Phone: MAYFAIR 0578/9.

BULLPHONE A.C. and D.C. ELIMINATORS

For volume and background silence.

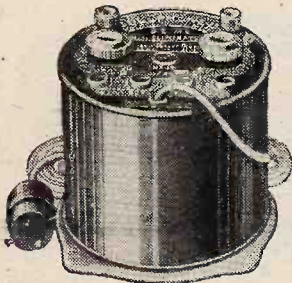

D.C. Model 1.

Total Output 25 m.a.
120 volts.

Price 27/6

D.C. Model 2.

25 m.a. 120 volts.

With two variable tappings 0-130 volts. One Power fixed tapping 120-130 volts.

Price 37/6

A.C. Models for all voltages between 110 and 250 volts, 40 to 100 cycles.

Prices from £3 19 0 to £10 10 0

Send for our Free Lists and Circuits—

BULLPHONE LTD. (Dept. W.W.)

38, HOLYWELL LANE, LONDON, E.C.2



AN AMAZING! NEW VALVE!

COLLOIDAL CATHODES
*for Durability! Sensitivity!
Volume! Long Life!*

The cathode of the new Vatec valve is plated with colloidal deposits for durability, sensitivity, volume and an extra long life. A filament of colloidal structure is a vast improvement on the now common "coated" filament, and the colossal emission of which it is capable means incredibly better tone and selectivity.

Ask your dealer to show you these amazing new valves. You will be really astonished at their outstanding performance.

**H.F. and
G.P.
6/-
SUPER
POWER 7/6**

VATEC

**THE NEW
STYLE VALVES**

ABBEY RADIO,
47, Victoria Street, London, S.W.1.
Telephone: VICTORIA 3914.

Listen and SEE

Sound and action at last perfectly reproduced together—that is what the Baird "Televisor" Home Reception Set has made possible.

Not just an interesting experiment nor the laborious building up of "still" pictures, but the portrayal in your home of what you would see if you were actually in the studio.

Daily broadcasts of both sound and vision from the National and Regional stations at Brookmans Park have been a feature since March 31st.

The Baird Television Company has given great thought and care in producing a Kit of Parts bearing the BAIRD brand. This will interest the Home Constructor and Experimenter, and will open up a new wonder to tax his ingenuity. Ample "Service" is arranged for.

Prices for the complete Receiver and "Televisor," "Televisor" only, and Kit of Baird branded parts will be sent on application to—

THE BAIRD TELEVISION
DEVELOPMENT COMPANY, LTD.,
133, Long Acre, London, W.C.2.

"TELEVISOR"
(Regd. Trade Mark)

HOME TELEVISION

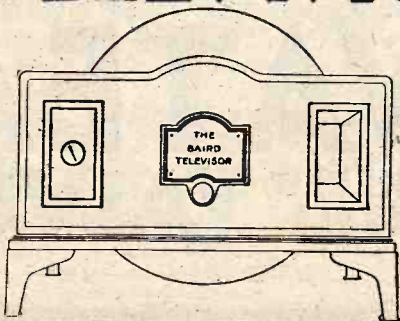

a phrase
that
heralds
the
birth
of a
great
radio
epoch

HOME

Mention of "The Wireless World," when writing to advertisers, will ensure prompt attention.



It's firmly clamped

Unvarying capacity is positively assured with a Dubilier Mica Condenser. Take, for instance, the Type 610 Condenser illustrated—before the "element" is sealed into the moulded case it is tightly clamped, so that absolute constancy of capacity is ensured. This is just one example of the way in which Dubilier safeguard the efficiency of their Condensers—Condensers which have gained a world-wide reputation for absolute reliability

DUBILIER MICA CONDENSERS

Type 610 (Horizontal) and Type 620 (Vertical). Test Voltage, 500 A.C.

·0005 to ·0009	2/6
·001 to ·006	3/-
·007 to ·009	3/6

Type B775. Tested at 500V. D.C.

Specially suitable for use in resistance-capacity coupled amplifiers, also where a condenser is required to withstand potentials of several hundred volts.

·01, 4/- ; ·1, 8/6 ; ·5, 37/6.

Intermediate capacities at proportionate prices.

If unobtainable from your dealer, write direct to us giving his name and address. Dubilier Condenser Co. (1925) Ltd., Ducon Works, Victoria Road, N. Acton, London, W.3.

Ask your dealer for the Dubilier Booklet—
"A Bit about a Battery"—it's free.

The Wireless World

AND
RADIO REVIEW
(18th Year of Publication)

No. 559.

WEDNESDAY, MAY 14TH, 1930.

VOL. XXVI. No. 20.

Editor: HUGH S. POCOCK.
Assistant Editor: F. H. HAYNES.
Editorial Offices: 116-117, FLEET STREET, LONDON, E.C.4
Editorial Telephone: City 9472 (5 lines).
Advertising and Publishing Offices:
DORSET HOUSE, TUDOR STREET, LONDON, E.C.4.
Telephone: City 2847 (13 lines). Telegrams: "Ethaworld, Fleet, London."
COVENTRY: Hertford Street.
Telegrams: "Cyclist, Coventry." Telephone: 6210 Coventry.
BIRMINGHAM: Guildhall Buildings, Navigation Street.
Telegrams: "Autopress, Birmingham." Telephone: 2970 and 2971 Midland.
MANCHESTER: 260, Deansgate.
Telegrams: "Iliffe, Manchester." Telephone: 8970 City (4 lines).
GLASGOW: 101, St. Vincent Street, C.2.
Telegrams: "Iliffe, Glasgow." Telephone: Central 4857.
PUBLISHED WEEKLY.
Subscription Rates: Home, £1 1s. 8d.; Canada, £1 1s. 8d.;
other countries abroad, £1 3s. 10d. per annum.
Entered as Second Class Matter at New York, N.Y.
As many of the circuits and apparatus described in these pages are covered by patents, readers are advised, before making use of them, to satisfy themselves that they would not be infringing patents.

CONTENTS OF THIS ISSUE.

	PAGE
EDITORIAL VIEWS	497
BUILDING THE POWER PENTODE-TWO. BY W. I. G. PAGE	498
THE FADING AND DISTORTION OF DISTANT SIGNALS. BY A. DINSDALE	504
PRACTICAL HINTS AND TIPS	507
CURRENT TOPICS	509
MY HOUSEHOLD SET. BY H. FLEETWOOD WALKER	511
LABORATORY TESTS ON NEW APPARATUS	513
TWO-WAY TELEVISION	514
WIRELESS THEORY SIMPLIFIED. PART XXX. BY S. O. PEARSON	516
BROADCAST BREVITIES	519
CORRESPONDENCE	520
READERS' PROBLEMS	521

RADIO SERVICING.

THERE are some people whose wireless sets are continually going wrong, and it is not always the fault of the set, because a certain type of user is quite obviously disappointed if he cannot find fault with his set in some detail or another. But these individuals are the exception, and there is a vast number of users of wireless sets who genuinely suffer from minor faults which occur from time to time, and if they are not technical enough themselves to put these matters right they are entirely dependent on—whom? It is just the uncertainty of the answer to this question which prompts us to write these notes.

We recently heard of a case which will serve to illustrate our point; a receiver, although of a somewhat old pattern, had been giving good service for several years, but one day the owner found that it would not function and called in the assistance of the local radio shop. He was told that a new accumulator was needed, and this was connected up for him, and then, as the set still failed to function, the expert said that the valves were worn

out and required replacing. The owner of the set knew just enough to believe that it was unlikely that valves which, a few days before, had been functioning happily, should suddenly become worn out, and so he told the expert that for the time being he did not propose to replace them. When we were asked to look at the set on his behalf, we found that what had happened was that the expert had put a four-volt accumulator on to two-volt valves, which was an adequate explanation of why the valves were worn out.

Training the Service Man.

Is the present treatment which the non-technical user is getting at the hands of his local dealer or expert fair to him, or fair to the manufacturer? We are quite prepared to admit that there are many retailers who give excellent service, but we believe that they are in the minority, and that a very great deal of harm is being done to-day, as has always been done, as the result of inadequate or inexpert servicing. Either the proper servicing of radio requires greater skill and experience than those engaged in the work have been able to acquire, or else the remuneration for the work of servicing is inadequate to attract the right class of man. Whatever the causes, there can be no denying the seriousness of the effects which are produced, and it seems likely that receivers which are not being adequately serviced will wane in popularity, however efficient they may be in performance.

The increasing complexity of receivers tends to complicate the problem, especially as the tendency to-day is towards mains operation and increasing the compactness of construction. The manufacturer, we know, aims all the time at being able to send out receivers so robust and so carefully tested that no servicing is needed, but even under ideal circumstances no manufacturer can guard against every eventuality.

Some of the bigger set manufacturers have already realised the importance of the servicing side, and are training their own service men expressly for that purpose, but those set makers who are in a smaller way of business are probably not in a position to follow this example. The question then arises whether the problem of servicing and the training—either by attendance at some suitable centre or by a correspondence course—of those who undertake the work is not a responsibility which, if not actually undertaken by the Radio Manufacturers' Association, should at least be organised and fostered by that body in the interests not only of the public but of its members as well, and thereby confer benefit all round.



BUILDING THE Power Pentode-Two

By W. I. G. PAGE, B.Sc.

Constructional Details—More about the High-voltage Pentode.

IN last week's issue consideration was given to the linear properties of the power grid detector and to the filter-fed L.F. transformer which could be connected to give a rising or falling characteristic at will. Before describing the construction of the receiver, some further notes will be given on the high-voltage pentode with special reference to the heating of the filament with raw A.C. The power output of the P.M.24A, as used in the receiver, when the load is correct and when the full grid swing is impressed, is calculated from Fig. 5 by multiplying AB by BC and dividing by 8.

The figures are $42 \text{ mA.} \times 285 \text{ volts} = 8 = 1,500$ milliwatts approximately. This represents a volume from the loud speaker in excess of that required for ordinary domestic purposes, but by means of the volume controls the desirable condition of using only a portion of the characteristic of the output valve may be realised. On the other hand, if sufficient volume for a small hall is required, the full grid swing may be applied.

The moving-coil loud speaker with its comparatively level frequency-impedance characteristic can give a brilliant performance, both as regards quality and volume, when used after a pentode, and there may be found on the market many such instruments with special speech coils. Whilst they are not so likely to need correcting devices, it is as well to experiment with the various step-downappings (A, B and C, Fig. 1), and to try the effect of the tone control. If the response curve is especially level, the value of C_{10} may be changed to 0.005 mfd. or 0.001 mfd. It is as well to remember that when the speaker load is removed the pentode is working into the high impedance of the output choke, and voltages well over 1,000 may be developed (see Fig. 5). The writer has seen a continuous spark discharge take place between anode and filament connections after disconnecting the speaker. The moral is obvious—never break the loud speaker circuit until the H.T. supply

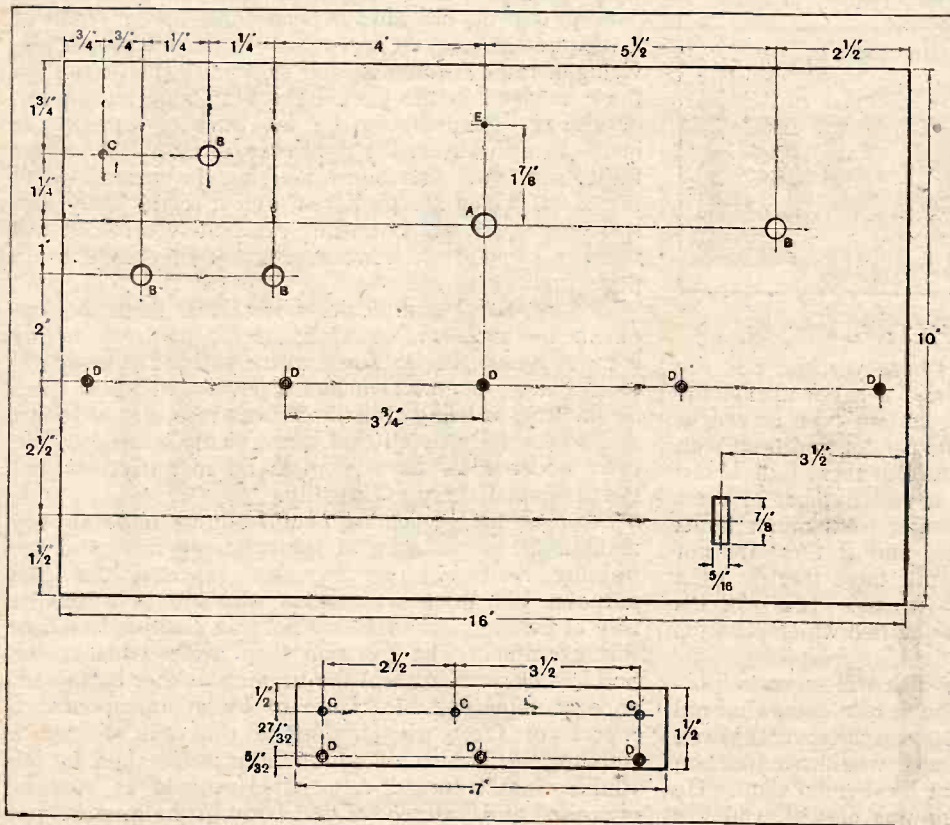

Dimensions and drilling data of the panel and terminal strip. A, $\frac{7}{16}$ " dia., B, $\frac{3}{8}$ " dia., C, $\frac{3}{8}$ " dia. D, $\frac{1}{8}$ " dia. countersunk for No. 4 wood screws, E, $\frac{3}{8}$ " dia.

The moving-coil loud speaker with its comparatively level frequency-impedance characteristic can give a brilliant performance, both as regards quality and volume, when used after a pentode, and there may be found on the market many such instruments with special speech coils. Whilst they are not so likely to need correcting devices, it is as well to experiment with the various step-downappings (A, B and C, Fig. 1), and to try the effect of the tone control. If the response curve is especially level, the value of C_{10} may be changed to 0.005 mfd. or 0.001 mfd. It is as well to remember that when the speaker load is removed the pentode is working into the high impedance of the output choke, and voltages well over 1,000 may be developed (see Fig. 5). The writer has seen a continuous spark discharge take place between anode and filament connections after disconnecting the speaker. The moral is obvious—never break the loud speaker circuit until the H.T. supply

Building the Power Pentode-Two.—

has been switched off, or, better still, until the mains switch has been opened.

The grid bias for the last valve is derived from the voltage dropped across the 1,000-ohm resistance R_6 . Each milliampere of combined screen and anode current causes one volt bias, and, as the total H.T. current for the last valve is about 20 to 22 mA., it follows that the bias from R_6 has the same value in volts. When a filament is directly heated with raw A.C., the bias in excess of that required when the valve is battery-heated is calculated¹ by dividing the filament volts by $\sqrt{2}$. The 22-volts negative potential is sufficient to include this. An insignificant increment is given to the bias by the 50-ohm potentiometer R_7 , which is in the H.T. return path; its effective resistance, from the point of view of bias, is 12.5 ohms, as the two 25-ohm limbs are in parallel. Due to the comparatively thin filament of the P.M.24A, there is a slight residual hum, especially with loud speakers having a good 50-cycle response, but it is of such small magnitude as to be inaudible when an unmodulated carrier is received. The new P.M.24B pentode should be quite free from hum, as its directly heated filament consumes 1.0 amp. at 4 volts. Its use in the receiver would demand a slightly larger mains transformer in order to deliver the greater anode and screen voltage, and this, in turn, would necessitate a rather deeper eliminator box. The bias resistance R_6 would also require alteration in value.

The anode and screen return leads are taken to the local earth point Z, and it is particularly important that C_8 should be made 4 mfd. The potentiometer R_7 has been made as low in value as is compatible with current consumption, for the reason that its two limbs when in parallel form a common path for input and output pulsations. As its resistance is 50 ohms, the current passed at 4.0 volts is 0.08 amp., so that the separate heater winding for the last valve must provide for this in addition to the filament current of 0.275 amp., making a total of about 0.36 amp.

Making the Eliminator.

To obtain immunity from back-coupling in an all-mains receiver with automatic bias, it is usual to decouple not only the anode but the grid circuit as well. The latter does not seem to be possible when an L.F. transformer is auto-coupled, as a high resistance would be included in series in the transformer primary circuit. A sufficient measure of decoupling results from the presence of C_7 together with the low value of R_7 . The reader may find that the removal of C_7 decreases the residual hum. This is undoubtedly due to lower amplification, for if the screen voltage were allowed to vary proportionately to the anode voltage and were not held down, then the pentode would behave like a triode and give reduced sensitivity. To retain the high

¹ See "Grid Bias Values," *The Wireless World*, Dec. 18th, 1929.

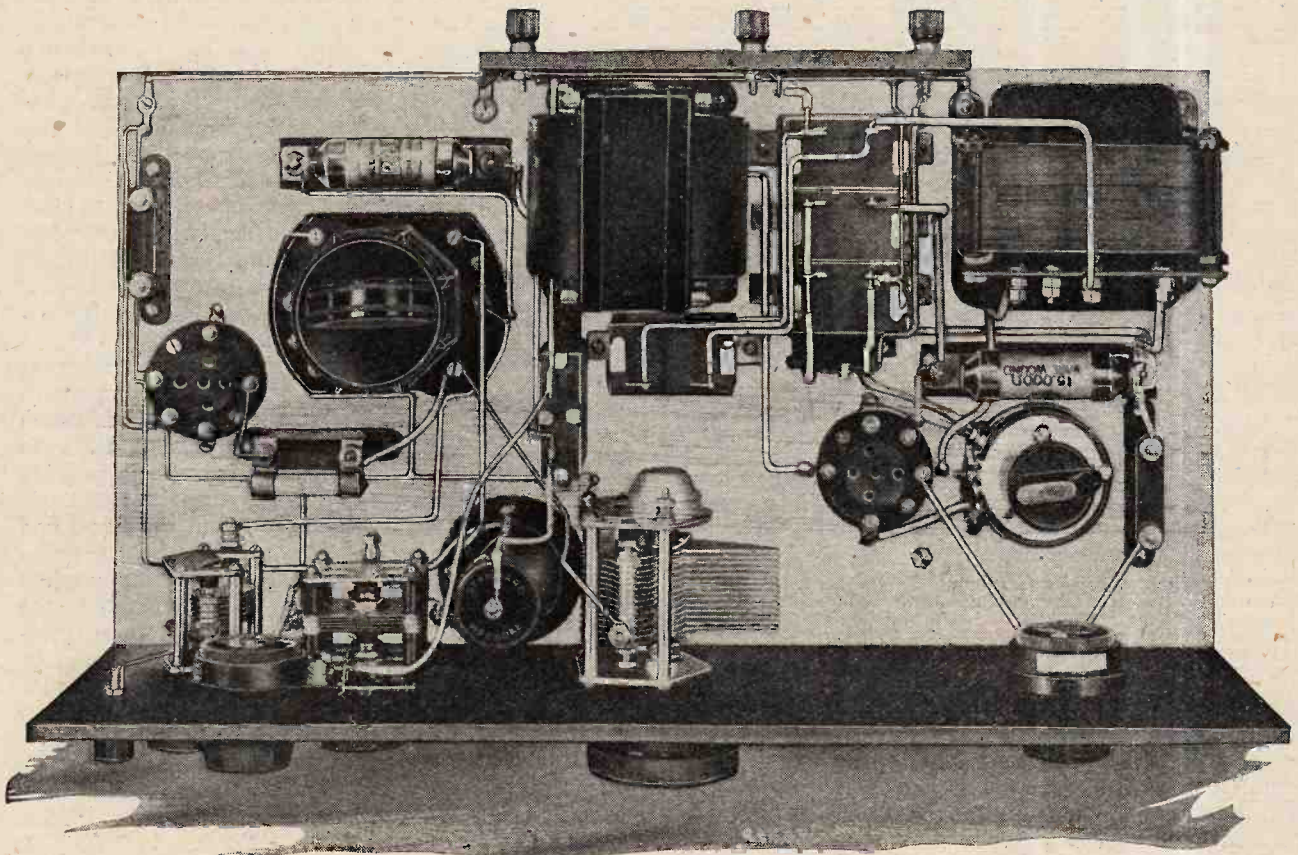

Plan view of the receiver. The variable resistance on the right of the panel is the adjustable element of the tone control.

Building the Power Pentode-Two.—

efficiency of the pentode, C_7 should not be removed. To maintain symmetry in the valve the "earthed" grid is joined internally to the centre of the filament.

The eliminator follows orthodox lines. The A.C. mains are connected *via* a two-pole, single-throw switch S to the mains-transformer primary, which is tapped for the various supply voltages. To avoid any chance of instability in a set in which the stage magnification is exceptionally high, separate feed arrangements have

regulation curves of the U.5 rectifying valve² shows that with an input of 285v. + 285v., there is an unsmoothed output of about 330v. across a 4-mfd. condenser when the load is 30 mA. This means that when 20 volts are dropped by the automatic grid bias, 310 volts are available at the input of the eliminator.

The first item when constructing the receiver is the attachment of the eliminator components to the plywood sub-baseboard and the completion of their wiring. As it is not convenient to use the sides of the eliminator

box to support any of the components, the two-pole mains switch is held in position by a piece of 16-gauge aluminium bent to form a right-angled bracket. To prevent the bulb of the rectifying valve from touching the baseboard, the vertical-mounting valve holder is raised half an inch by a piece of wood. As the mains transformer must be mounted on its side, it is bolted to a short length of angle bracket which, in turn, is screwed to the baseboard.

The complete eliminator on its baseboard is next put into the metal containing-box, and the whole bolted by means of four 4B.A. screws to the main baseboard. The heads of two of these screws can be seen in the plan view of the receiver; one of them is close to the pentode valve holder, the other forms one of the main earthing points, and is close to the earth terminal.

The next procedure is to attach the components to the main baseboard and panel, and then to secure the panel in position by means of the two angle brackets and the five wood screws visible on the panel front. When the terminal strip has been fixed, the wiring can then be completed.

It is important that a small space should be left between the back of the panel and the eliminator box to allow the easy removal of the metal cover. Careful inspection of the wiring diagram will show that all metal frames and cases are earthed.

For simplicity of control one-dial tuning has been arranged, and, whilst the aperiodic aerial rotor scheme

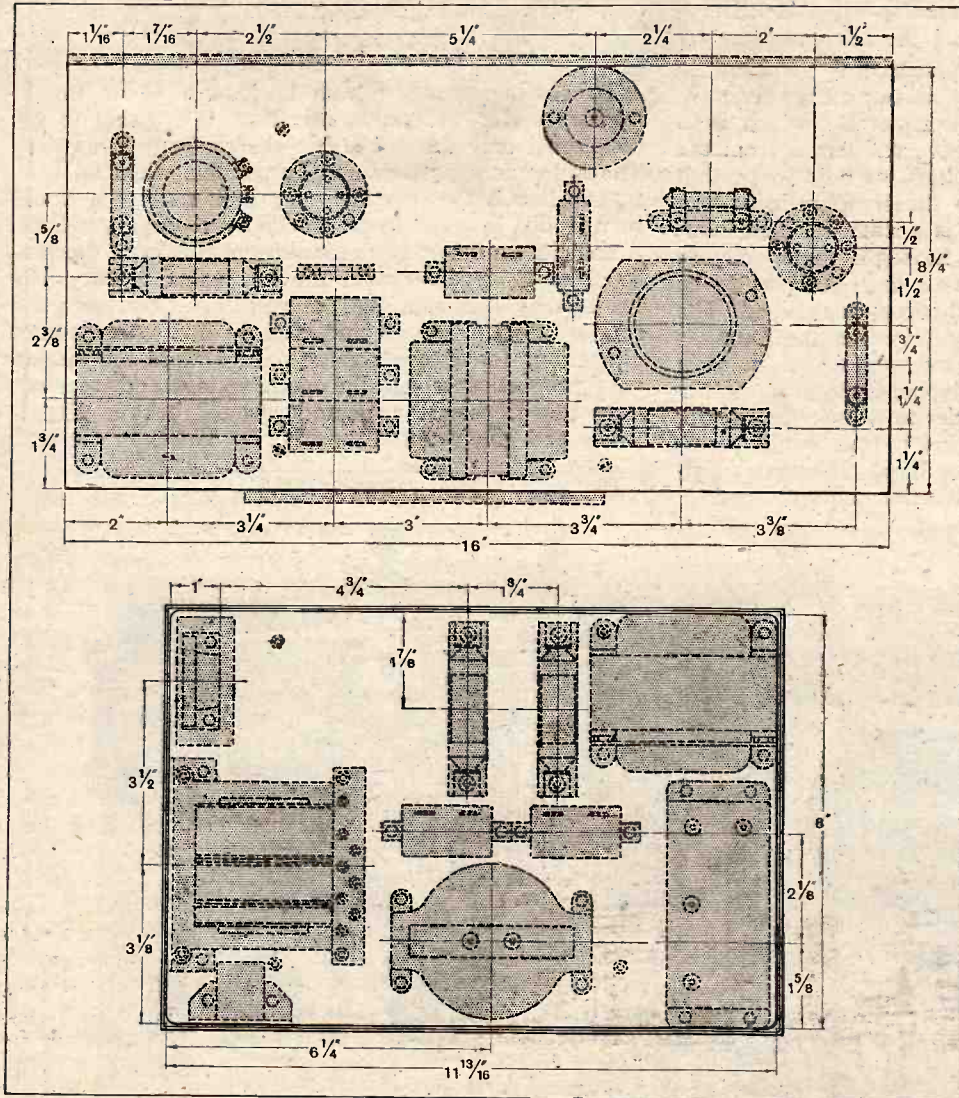

The disposition of the components on the main baseboard and (below) on the sub-baseboard in the eliminator box.

been made for both anode and heater of each valve. The values of the smoothing chokes L_5 and L_6 and anode decoupling resistances R_8 and R_9 are given in Fig. 1. The smoothing condensers C_{13} , C_{14} and C_{15} take the form of a tapped condenser block with common earth terminal; this makes for compactness. It is particularly important to use condensers tested to the voltages specified in the list of parts so as to avoid breakdown due to surge pressures. An examination of the voltage

² See "Mains Rectifiers," *The Wireless World*, Feb. 19th, 1930.

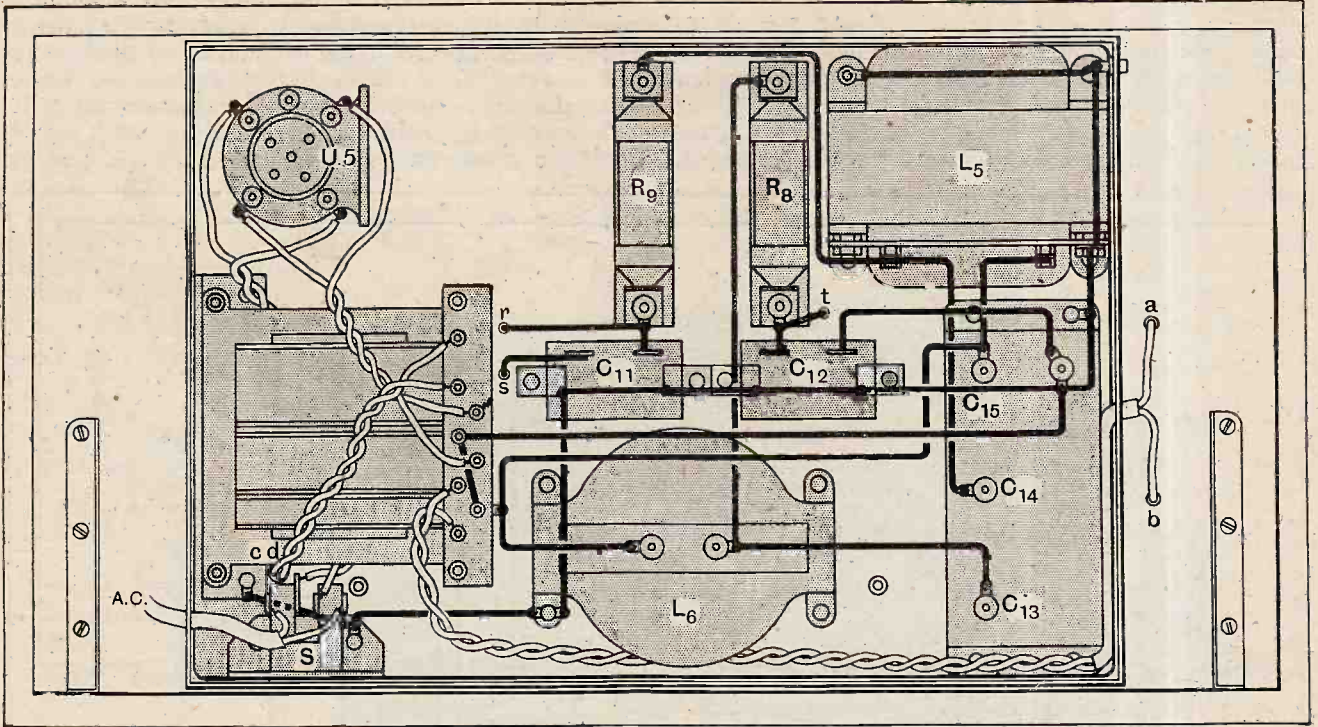

Wiring connections for the components secured on the under-baseboard, where the eliminator is housed.

as used on the medium broadcast band gives adequate selectivity, it is found that this simple arrangement without a second resonant circuit allows medium-wave stations to appear at the lower end of the condenserial reading when working on the long waveband. Especially is this noticeable near London. The set as described covers only the medium waveband, but for

those living near 5XX there is a dual-range Colvern coil, type R.M.2S, available with wave-change switch in the base. No alteration whatsoever to the wiring is necessary when this coil is connected. Details of the medium-wave coil are as follows: The secondary has 52 turns of No. 30 D.S.C. wire wound 48 turns per inch. The reaction winding, spaced about $\frac{1}{4}$ in. from the low-potential end of the secondary, contains 17 turns of No. 34 D.S.C., whilst the aperiodic aerial rotors, which are interchangeable, can be obtained with 20, 30, 60, or 100 turns of No. 30 D.S.C. wire. The coil is sent out with a 60-turn rotor as standard; this gives a fair compromise between selectivity and sensitivity, but where the demands for selectivity are more exacting a smaller rotor should be obtained.

In the series of articles entitled "Wireless Theory Simplified," it was shown that, given fixed secondary and aerial constants, there is only one aperiodic aerial winding and coupling condition that will give maximum signal strength for any one wavelength. Any

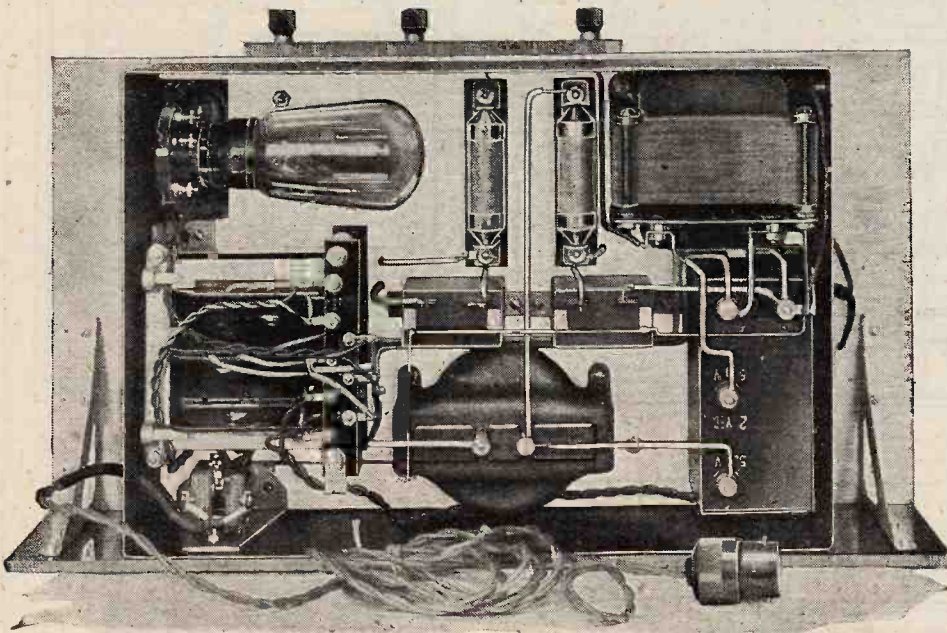

View of under-baseboard layout. The complete eliminator with metal cover removed.

Building the Power Pentode—Two.—

of the four rotors of different inductance referred to can be used and swung round a horizontal axis or moved bodily in a vertical plane from the top to a position near the bottom of the secondary coil former, giving an infinite variety of couplings. By this means satisfactory selectivity and sensitivity are obtained for aerials

of different lengths and for localities up to about fifty miles from the more powerful broadcasting stations. The most perfect rectification is given by the power grid detector when the input is large and, therefore, when the set is receiving a nearby transmission. At a distance of, say, fifty miles, where the input is not impressed wholly on the linear part of the grid current

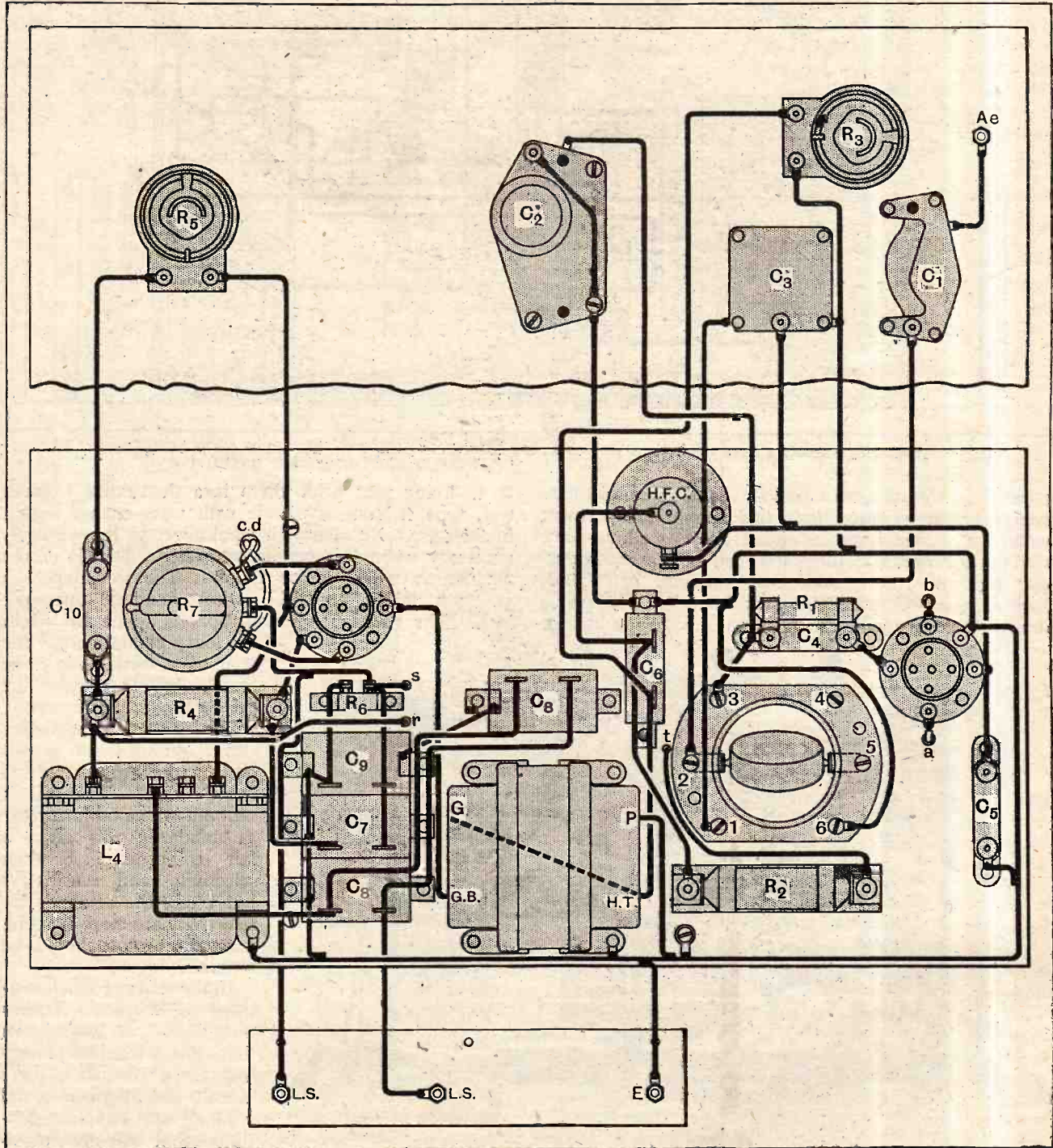

The wiring diagram of the components mounted on the panel and main baseboard. Note that the 4-mfd. capacity for C₃ is provided by two 2-mfd. condensers in parallel.

Building the Power Pentode-Two.—

curve, the rectified output is more free from distortion than that from an ordinary leaky-grid detector, although, perhaps, not entirely beyond reproach.

To make the four small control knobs on the panel uniform, it is necessary to increase the diameter of the spindle of the Volcon series aerial condenser to $\frac{1}{4}$ in. by wrapping a few turns of 20-gauge wire around it or by obtaining a split bush from the makers. Those possessing a milliammeter of suitable range should interpose it at X to see that the anode current is about 8 mA. when no signal is being received. The optimum drop with a strong signal is about 1.5 mA., bringing the reading down to 6.5 mA. The current at Y should be about 20-22 mA.

Having completed the construction of the receiver it now remains to give hints on operation. The two valves and the mains rectifier should be inserted into their holders; the correct connection to the primary of the mains transformer to suit the supply voltage having already been made. Insert a 60-turn rotor in a horizontal position into the second or third holes of the metal contact strips inside the aerial coil. Turn the reaction, volume, and tone controls anti-clockwise as far as they will go, and see that the series aerial condenser is at the position of full capacity. Connect the earth lead and the loud speaker, but not the aerial. Switch on; after some 20 seconds, when the A.C./H.L. has warmed up, there will probably be a loud hum. Slowly turn the potentiometer until this becomes a minimum, connect the aerial, and tune in to resonance a powerful transmission. Turn the volume control clockwise until the desired loud speaker strength is obtained, and, if necessary, increase the selectivity

by judicious use of the series aerial condenser together with a change in the angle and vertical position (or both) of the aerial rotor. To lower the tone, turn the control on the extreme right of the panel clockwise. It will be found that both the reaction and volume controls slightly alter the pitch; this can be corrected to a large extent by the tone control. The speaker should be connected through C_8 , in turn, to A, B and C, to find out which tapping gives the best bass response.

The A.C. consumption of this receiver, which is about

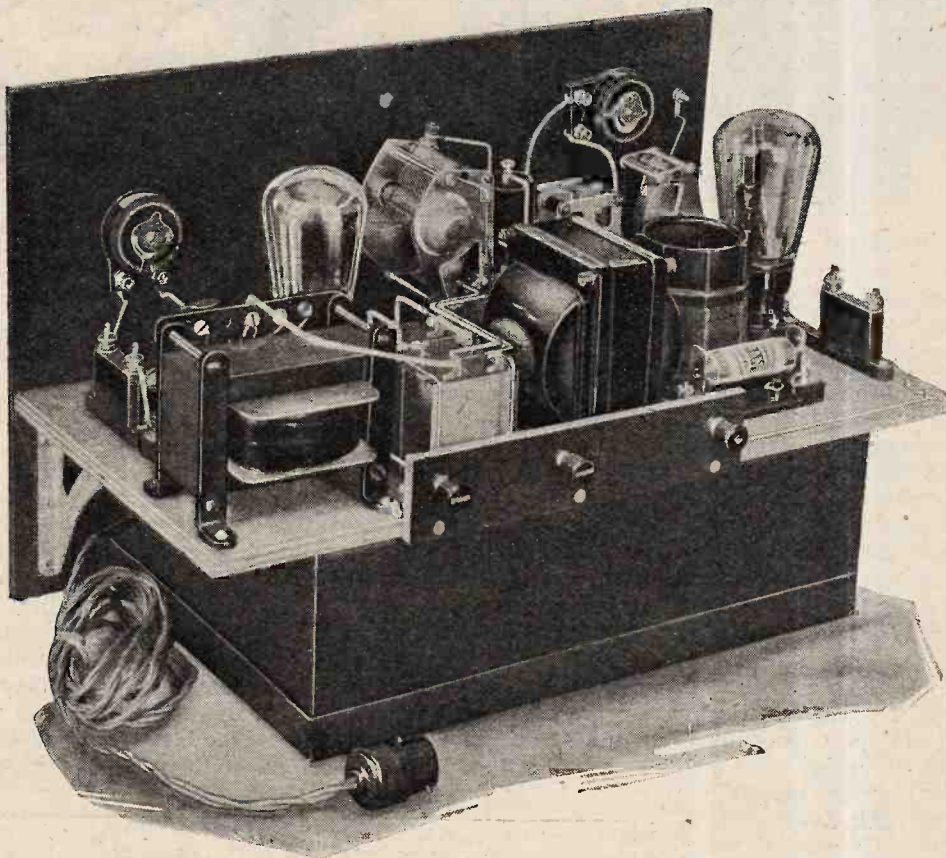

Rear view. The tapped pentode output choke can be seen in the foreground.

30 watts, can be claimed as modest. If the set is used for three hours each evening in a district where a lighting unit costs 4d., the total weekly running cost will be about 2½d.

This receiver is available for inspection at the Editorial Offices, 116/117, Fleet Street, London, E.C.4.

BOOK REVIEW.

National Physical Laboratory, Collected Researches, Vol. XXI, 1929. Pp. IV+449. His Majesty's Stationery Office, Adastral House, Kingsway, London. £1 2s. 6d.

The volume contains twenty-two papers, all but one of which have already been published elsewhere, the exception being the paper by Dye and Hartshorn on a Primary Standard of Mutual Inductance for presentation to the Imperial Government of Japan. This replaces the one described by Dr. Dye in Vol. XVIII of the Collected Researches, which was destroyed in the earthquake of 1923. It is of the Campbell type, and is very similar to the N.P.L. 1907 standard. Its construction and cal-

culation is described in the paper, together with the experimental tests which showed that the units realised by the two standards differ by a few parts in a million.

Of the reprinted papers three are by Dye, six by Hartshorn, three by Wilton, one by the two last named jointly, five by Smith-Rose and Barfield, two by Hollingworth, and one by Webb. They are all on electrical subjects, and twelve of them on radio telegraphy. It is hardly necessary to say that they are all of a very high standard of excellence. To anyone interested in accurate electrical measurements it will be a great convenience to have these otherwise scattered papers bound up in a single volume.

G. W. O. H.

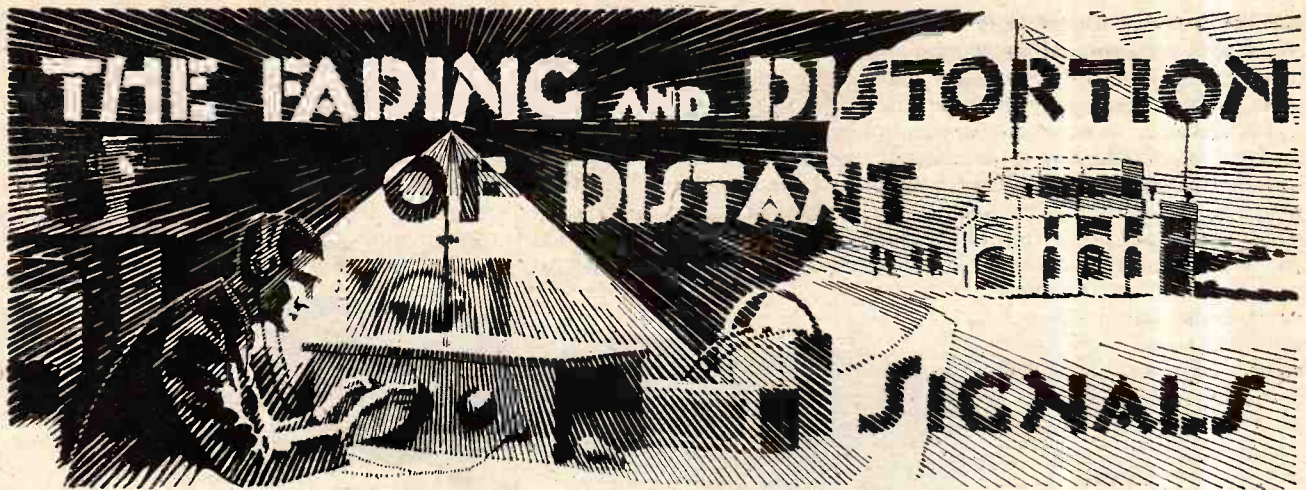

Suggested Explanation of "Ghost" Images in Experimental Television Reception.

By A. DINSDALE.

IS television broadcasting about to provide us with new evidence concerning fading and that "hollow" sound which received signals sometimes assume, and which we have so far explained as being due to mutual interference between the space and ground waves? Both these effects are so common as to be well known to everybody who has listened to distant broadcasting stations, and to stations working on wavelengths below the broadcast band.

The accepted theory to account for the observed effects is that every wireless transmitter emits two sets of waves, called ground and space waves. The ground wave, as its name implies, is supposed to travel along the conducting surface of the earth from transmitter to receiver. The space wave, on the other hand, shoots off into space tangentially to the surface of the earth until it meets the ionised, or conducting, Heaviside layer, which reflects the wave back down again to earth; or several reflections may take place from widely separated points on the inner, or concave, side of the layer before the wave is eventually bent down to earth again.

The distance-covering power of the ground wave depends upon the wavelength; the longer the wavelength the farther it travels. As the wavelength is reduced so the ground component of the radiated wave becomes attenuated, or weakened, by absorption by the earth, until finally it disappears altogether. A receiver situated beyond the range of the ground wave must therefore depend entirely upon the space wave, and it is possible that it may be so situated that the space wave is in process of being reflected by the Heaviside Layer high above it.

In this circumstance no signals can be received, and we have an example of the "skip distance" effect which is so common on short waves, and, indeed, on wavelengths as high as 600 metres.

The Cause of Fading.

Broadcasting authorities are well aware that a good and reliable service area for their stations can only be guaranteed within the limits of the ground wave; beyond this distance reception is likely to be variable either in strength or in quality, or both. Many powerful European broadcasting stations have proved disappointing to their builders because they will not serve reliably the entire area which they were designed to cover; in some districts, apparently well within their range, they are inaudible. And yet the writer has frequently heard these stations coming through strongly and undistorted

1,000 to 1,500 miles out in mid-Atlantic. At places much nearer the stations concerned the ground wave has died out, and the space wave passes overhead, to come down again in mid-Atlantic. Daventry 5GB is one such station.

At intermediate distances, at night, it frequently happens that energy is being picked up from both ground and space waves simultaneously. Under such

conditions, fading and distortion are almost certain to occur at more or less frequent intervals, and often at very regular intervals. This is easily explained by reference to Figs. 1 and 2, which illustrate the paths taken by signals between London and Berlin, a distance of roughly 800 miles in a direct line.

In Fig. 1 both ground and space waves are shown,

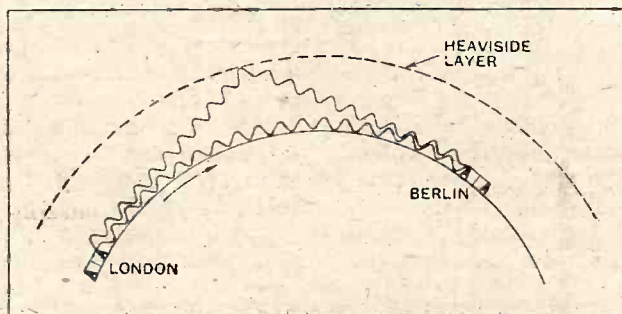

Fig. 1.—Ground wave and space wave radiated from London arriving at Berlin, 800 miles away, in phase with each other.

The Fading and Distortion of Distant Signals.—

the latter after one reflection only from the Heaviside layer; as already explained, there may be several reflections. The important point is that the two waves arrive at Berlin in phase. Obviously, as the space wave has to travel farther than the ground wave, we should hear a double signal, like an echo, but in ordinary broadcasting it is not noticeable. Evidently our ears are very accommodating. In cases where wireless signals are recorded, as, for example, in the case of short-wave automatic high-speed telegraphy, duplicates of the original signal have frequently been recorded, and are often due to a short-wave signal having travelled right round the world one or more times, each traverse leaving its own record on the recording tape.

By Two Paths and Out of Step.

In Fig. 2 the two waves are arriving 180 degrees out of phase. Considering that both waves travel by different routes; one taking longer than the other to arrive, it is surely only a matter of luck that they ever arrive dead in phase at all. If they are 180 degrees out of phase, and both of the same strength, it is logical to assume that they will cancel one another out, and no signal will be heard. If they arrive at equal strength, but at intermediate phase positions between 0 and 180 degrees, then fading and probably distortion will result. If one wave is stronger than the other, then phase displacement will again cause fading and distortion. The combinations of circumstances which may arise are innumerable.

Such are the conditions as they affect sound broadcasting. Now that experimental television transmissions are taking place from the 261-metre National Programme transmitter at Brookmans Park, an interesting observation has been made by a German enthusiast¹ in the course of his experiments in the reception of the images.

It is reported that during the night transmissions he has observed, as well as the main image, a second ghost image, or, as he calls it, an "echo image." He does not offer any explanation of the phenomenon, but he obviously has in mind the long-delayed echo signals which have been observed on short waves. Such echo signals have not so far been observed on the broadcast wavelengths.

Here are some extracts from the report:—

"During a time of three or four seconds the image 'faded over' into another image 10-20 'picture elements' higher. When the *original image* ('fully synchronised,' of course, and standing still) faded *down* to a large degree *another image faded on* at the same time,

showing the same picture *twice*, one in the frame and one 10-20 elements higher. Sometimes during the time two pictures were to be seen, one above the other, phase-shifted 180 degrees (negative picture) for a few minutes. The phenomenon did not arise from a lack of synchronism, but was due to an external cause."

This seems to point clearly to the fact that, with reception proceeding satisfactorily by means of either the ground or the space wave singly, signals began to arrive from the second wave which were practically in phase, but slightly displaced as to time. In the Baird system, images are scanned from bottom to top, starting from the lower right-hand corner. Therefore, since the second image seen appeared *above* the main image, this indicates that the signals giving rise to it arrived *after* the main-image signals. It is, therefore, logical to assume that the interfering signals were due to the space-wave component. Later reports indicate that whenever these double images appear they are always 10-20 picture elements apart.

Will the distance between the two simultaneously visible images give us a means of calculating the delay in the arrival of the space wave? If so, then we can work out the length of the path followed by the space wave, and by triangulation calculate the height of the Heaviside layer.

The report states that the distance between the two images was 10-20 picture elements, so that an explanation of the term picture elements is first of all necessary. It is a purely arbitrary term, adopted for convenience, and arises out of the fact that in the Baird system of vertical scanning the 30-hole disc produces thirty vertical

lines which conveniently divide the width of the image into thirty sections. There is no similar demarcation along the length of the picture, so each vertical strip is assumed to be subdivided into squares. Since the picture ratio (i.e., ratio of length to width) is 7 to 3, each vertical strip is therefore comprised of 70 squares. It must be emphasised that these squares have no actual physical existence; for calculation purposes it is convenient to thus arbitrarily subdivide the image. Thus, the total number of arbitrary units, or picture elements, is $70 \times 30 = 2,100$. In his report the observer means 10-20 picture elements in a vertical direction.

Estimating the Time Interval.

With these few words of explanation we can proceed to some calculations, and for this purpose we will deal with one figure only, an image displacement of 10 elements.

In the present television broadcasts the image is scanned $12\frac{1}{2}$ times per second, which means that the period of one complete scan is 0.08 second. Thirty vertical strips go to make up one complete scan, so the

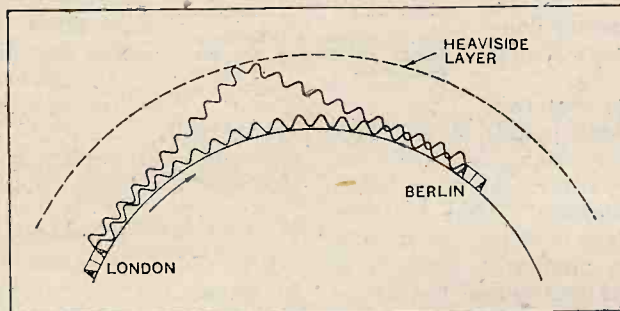

Fig. 2.—Ground and space waves arriving at Berlin 180° out of phase with each other.

¹ Horst Hewel, Berlin.

The Fading and Distortion of Distant Signals.—

time for each strip is $0.08 \div 30 = 0.0266$ second. A vertical image displacement of 10 elements amounts to one-seventh of the total height of the image, or length of a strip, so that the interval of time between the two images is $0.0266 \div 7 = 0.0038$ second, or 3.8 millisecond.

These figures appear to agree roughly with those given by Prof. E. V. Appleton in a recent letter to *The Wireless World*, in which he states that "for broadcasting signals as used in the Baird transmissions at present the time lag between the ground and atmospheric signals at a distance of 60 to 80 miles would be about 0.33 millisecond." The figure for the lag worked out above is roughly ten times as great, but so is the distance; and the result arrived at is in any case dependent on the accuracy of the observer's estimate of the distance between the two images.

The negative images which are referred to clearly indicate interference between the two waves. In television reception, if a negative image is received it indicates that the output signals of the amplifier are 180 degrees out of phase, and the remedy is to add another stage of amplification, or reverse the primary connections to the output transformer if one is in use.

In another report it is stated that two overlapping images were seen for periods of some ten seconds. "The two heads were moving together; the hair of one head was in the mouth of the other head. Sometimes the images were negative. Due to these echoes, I could not recognise much of the transmitted objects for a long time." On another occasion it is reported that "when no object was before the transmitter I observed a threefold image of the synchronising lines. The tone of the television impulses in my loud speaker distinctly altered during this period. Each synchronising strip (of the three strips visible 10-15 elements apart) was also continuously altering its blackness (or strength)."

These threefold images were obviously due to multiple reflection of the space wave from different points of the Heaviside layer, thus causing part of the space-wave energy to take a longer route and arrive later, to produce a third image.

The fact that the synchronising strips varied continuously in strength does not augur well for the suc-

cess, under such circumstances, of the method of synchronising as used in the Baird system by means of a dividing line or strip between successive images.

A very interesting confirmation of the appearance of ghost images has just come to hand from America, where Dr. Alexanderson, of the G.E.C., recently broadcast, through the short-wave Schenectady transmitter, 2XAF, television signals of a black rectangle drawn on a white card. These signals were picked up at Wellington, N.Z., rebroadcast to Australia, and relayed thence to America through the short-wave station 2ME at Sydney. Commenting on the appearance of the image which he received at his laboratory after its double journey, totalling in all about 20,000 miles, Dr. Alexanderson says:—

"The image would come in single design and would be quite clear for a period of time; then it would be doubled, tripled or quadrupled in some sort of cycle. It would end with a blur which would make the result indistinguishable, but would start over again, as the cycle returned, to become recognisable once more. It was as though we were actually looking at the various paths the signals had taken, and we were watching them come into phase and step out again."

Dr. Alexanderson sums up by adding: "By such experiments as this I am sure we can gain more actual knowledge of what does take place than with any purely aural system of check on the transmissions."

Remedy for Fading.

With this expression of opinion the writer ventures to agree. Certainly it does seem as if a television receiver, or a suitably modified version of it, may be of the utmost value in mapping out the courses and idiosyncrasies of ground and space waves, and also in showing clearly which of the two waves is responsible for the most constant reception at various distances from a given transmitter. In time we might even find ways and means of cutting out an unwanted interfering component, or components, of an emitted wave which we desire to receive free from interference and distortion. Or we might devise some form of intermediate mixing circuit which will deal with all incoming components of the signal wave and pass them on to the final stages of the receiver in correct phase. Who knows?

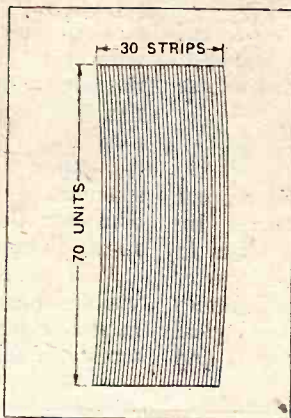

Fig. 3.—How a television image is divided up, for convenience, into picture elements or units.

Radio Instruments, Ltd., 12, Hyde Street, New Oxford Street, London, W.C.1.—Thirty-six-page illustrated catalogue of R.I. components. Included are four additional N.P.L. curves showing the amplification afforded by the "Hypermu" transformer when used with modern A.C. and battery-fed valves. Also leaflets dealing with a new moving-coil loud speaker.

Lissen, Ltd., Lissenium Works, Worples Road, Isleworth, Middlesex.—Illustrated

Catalogues Received.

folder of "Lissenola" radio-gramophones, portable and transportable sets.

S. Smith and Sons (Motor Accessories), Ltd., Cricklewood Works, London, N.W.2.—Illustrated folder of H.T. and L.T. accumulator batteries for all wireless purposes. Hitherto this firm has specialised in car starter batteries.

Asea Electric, Ltd., 5, Chancery Lane, London, E.C.4.—Illustrated catalogue and price list of "Century" single-phase, polyphase, and D.C. motors of from $\frac{1}{8}$ b.h.p. to 60 b.h.p.

Igranic Electric Co., Ltd., 149, Queen Victoria Street, London, E.C.4.—Descriptive leaflet of a switch adaptor which plugs into a valve holder and provides a ready means of connecting a gramophone pick-up to the set without modification to the wiring.

..... PRACTICAL HINTS & TIPS

VALVE PINS

Partial or complete failures of apparently insignificant details of a receiver are often just as puzzling and difficult to trace as faults of the more serious kind. There is little doubt that a census taken by wireless-set repairers would show that an overwhelming majority of so-called breakdowns are not really breakdowns at all, and that inability to receive signals is caused by some trifling defect brought about by neglect.

Faults, particularly those of an intermittent nature, may often be traced to a valve pin that does not make good electrical contact with its socket. It is suggested that, where fluctuations in signal strength are noticed—especially if such charges coincide with vibration imparted to the receiver—time will be well spent in making sure that all the pins are fitting perfectly. On the principle that prevention is better than cure, it would perhaps be better to go farther, and to recommend that this attention be given as a part of the periodical overhaul that every set should receive—but so seldom does! In sup-

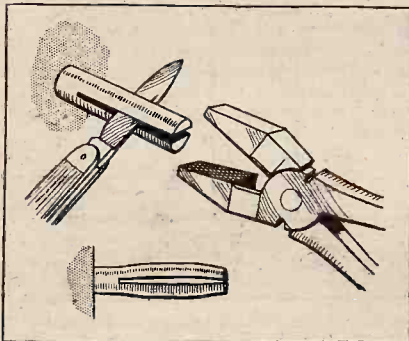
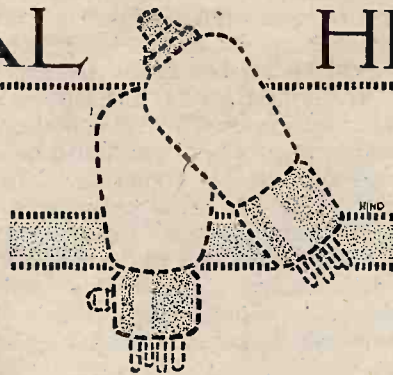

Fig. 1.—The best method of restoring the resiliency of split valve pins.

port, it could be urged that the operation of a super-power valve with a free grid, even for quite a short space of time, might well have serious results, as in the event of a contact failure between the grid pin and its corresponding socket, anode current would in many cases rise to a dangerously high value.

B 13



Simplified Aids to Better Reception.

Apart from the question of oxidation of the metal surfaces, it is found that the slots cut in the pins to provide resiliency tend to close up, partly as a result of removing and reinserting the valve in its holder; this accounts largely for poor contacts.

There is a right and a wrong way of carrying out the apparently simple job of restoring the springiness of the pins. Dealing first with the simple type having but a single slot, it will be realised that the expedient of opening it out by merely inserting a knife-blade is not beyond criticism. Assuming the natural diameter to be less than that of the socket, this procedure will not do very much more than provide two single points of contact at the extremity of the pin. A better plan is that indicated in Fig. 1: having splayed out the two parts with a knife, the ends should be lightly pressed together with a pair of pliers before the blade is removed. This gives a more or less parallel-sided springy plug and increases the chances of obtaining contact at a number of points.

The more modern "banana" plug, which is of tubular form with four slots which do not extend quite to the end, is illustrated in Fig. 2A. In this sketch the top of the pin is cut away to show the connecting wire, which is soldered where it passes through a hole in the point. This wire is occasionally—but, happily, very rarely—responsible for trouble. Due to the pressure exerted by a tight-fitting socket, the sides of the plug tend to close up,

as shown in sketch B; if one attempts to open them by driving a knife blade right through there is a remote possibility of breaking the rather fragile wire. A safer plan is that suggested in sketches C and D; if a knife is chosen its point should be inserted to a depth not greater than one-half the diameter of the pin, and the back should be used rather than the cutting edge. A small, sharp screwdriver is probably a better tool for the purpose; its blade should be forced into the slot, and a gentle twisting movement applied to its handle.

After having attended to the slots the pins may be cleaned with the

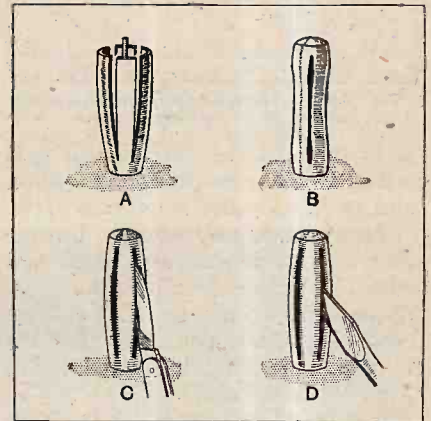

Fig. 2.—Sketches showing the construction of hollow "banana" valve pins and methods of opening the slots.

finest emery paper, or, if it is not available, they may be lightly scraped with a knife.

Valves with solid pins are now coming into use. They are intended to be fitted into holders with spring sockets, to which our attention must accordingly be transferred, although occasional cleaning of the pins will still be indicated.

o o o o

A GOOD "EARTH."

Hum in A.C. receivers can often be prevented, or at any rate minimised, by improving the "earth" system. As a rule, a connection to a large buried metal plate is likely to be better, from this point of view, than to a water pipe.

Practical Hints and Tips.—

FILTER UNITS.

As the best place for a band-pass filter is generally agreed to be between the aerial and the first valve of the receiver, it follows that the addition of this system of tuning to a receiver need not involve any very sweeping modifications of existing apparatus. To prepare the way for this conversion all that is necessary

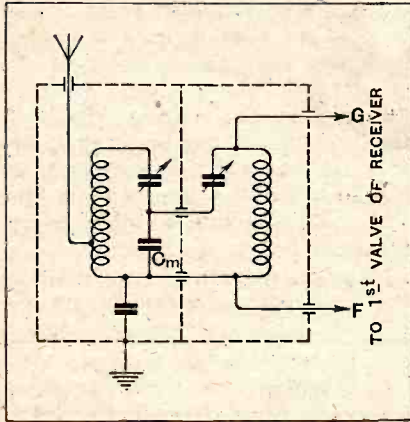

Fig. 3.—A capacity-coupled filter unit for adding to an existing receiver.

is to strip the existing input grid circuit wiring, to insert the filter, and to transfer the aerial connector.

This sounds easy enough, but the difficulty of inadequate space will generally make it difficult to house the extra apparatus in the same container. In such cases, nothing remains but to build the filter in the form of an external unit.

If the capacity-coupled arrangement, as described at length in the issues of *The Wireless World* for April 2nd and 9th, is adopted, the circuit of this unit will be given in Fig. 3. In this diagram C_m is the coupling condenser, while the connections to grid and filament of the first valve are indicated respectively by G and F.

In order that the operation of the filter may not be upset by extraneous couplings, reasonably effective screening between the coils is necessary, and it is convenient in practice to combine screen and container by mounting the whole unit in a metal box with two compartments.

A tuner with this circuit arrangement is suitable for addition to practically any receiver, with the important exception of the type having a regenerative detector without any

H.F. amplification. Sets of this kind can be modified by adding a reaction winding, as shown in Fig. 4, but it would be over-optimistic to suggest that the arrangement is really easy to operate or even that it is perfectly satisfactory when manipulation of its controls has been mastered. This is because all the circuit controls— aerial, secondary, and reaction—are interdependent, but where conditions are such that the sensitivity of the detector, without regeneration, is sufficient for normal reception, it has its uses.

Ganged control of the two tuning condensers, in conjunction with a "trimmer," makes for rather easier operation of this type of filter, in conjunction with a simple regenerative set, as it partly removes the necessity for maintaining exact syntony when reaction is set at anywhere approaching its limit; unless this is done, variations in loading will provoke actual self-oscillation when either circuit is detuned. There is, unfortunately, no completely satisfactory way of combining a double-circuit tuner with a regenerative set except by interposing a high-frequency amplifying valve.

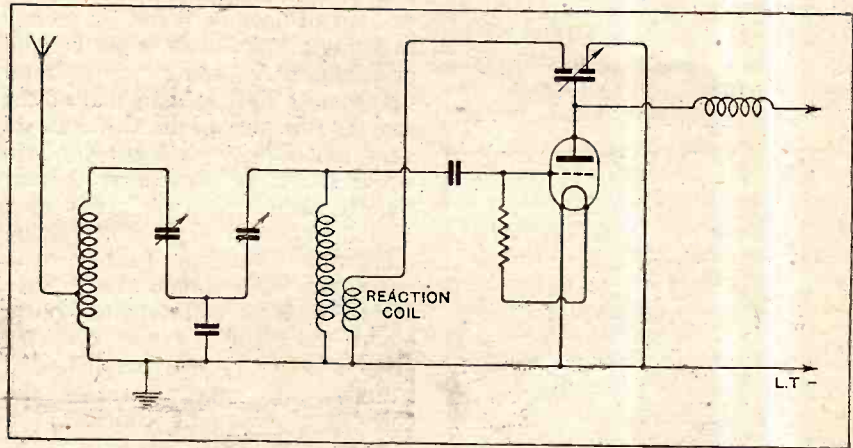

Fig. 4.—Detector valve with differential reaction control and a capacity-coupled input filter.

COMPRESSION CONDENSERS.

So-called semi-variable condensers are usually made up of two metal plates, or, in the larger capacities, of two sets of plates, with interleaving sheets of mica. Capacity is varied by a set screw, rotation of which tends to reduce or to increase the spacing between plates.

To minimise hand-capacity effects it is necessary that the set of plates

which makes metallic contact with this adjusting screw should be joined to the earthed or low-potential end of the circuit. Identification marks are not normally provided for the terminals, but their internal connections are easily traced, without dismantling, by making an electrical test. Before doing so it is, of course, essential that the control knob should be screwed home sufficiently for contact to be made between the screw and metal plate.

POINTS IN SCREENING.

Collapsible metal boxes, made of sheet aluminium and supplied in a form ready for bolting together by the home constructor, are deservedly popular, as they provide at least a partial solution of the screening problem—a problem that is still responsible for most of the difficulties encountered by would-be builders of highly sensitive sets.

In cases where it is possible if is to be recommended that adjacent boxes should be mounted with a small air space ($\frac{1}{4}$ in. or more) between them. It has been found that certain undesirable interstage couplings which tend to produce

instability are often avoided by taking this simple precaution.

Similarly, the flanged joints of these boxes may sometimes be found to allow of too much flux leakage. Electrical sealing may readily be improved by inserting strips of copper or brass gauze, through which holes to pass the assembling screws may easily be made with any sharp-pointed tool.

CURRENT TOPICS



Events of the Week in Brief Review.

WIRELESS PICTURES ON ATLANTIC AIR TRIP.

During the flight of the R. 100 to Canada at the end of this month, weather charts transmitted from Cardington will be received on board the airship by means of a Fultograph.

○○○○

POLICE WIRELESS IN FRANCE.

The Eiffel Tower, which has performed so many rôles in its career as a wireless station, is now to be a centre of a police radio network. The short-wave plant will shortly maintain hourly communication with police stations at the boundary towns and seaports. A secret wavelength will be used.

○○○○

CAR RADIO RALLY.

An automobile radio rally is to be held in Lille on Sunday, May 25th. Prizes will be awarded to the owners of the best car radio receivers, marks being given for compactness and efficiency. The efficiency tests will be carried out on signals received from the mobile transmitter 8HV, fitted on the car of Mr. Rongeron. About 120 competitors are expected.

○○○○

A PRACTICAL GIFT.

Every blind person in Gloucestershire will benefit by the generosity of Mr. H. W. B. von Schröder and his bride, Miss Margaret Darell. At Miss Darell's request, her wedding present will take the form of the gift of a wireless set to every blind person in the county. The cost will be approximately £10,000.

○○○○

TRANSATLANTIC AFTER-DINNER TALK.

Sir Ernest Rutherford, President of the Royal Society, is to deliver in London a speech which will be heard at a banquet of the Canadian Royal Society in Montreal on May 21st. The Post Office Transatlantic Telephone service via Rugby will be used. Sir Ernest will speak for twenty minutes, beginning at 2 a.m. on May 22nd, and the speech will be picked up by the Yamachiche station of the Canadian Marconi Co.

○○○○

INTERNATIONAL RADIO SHOW.

Radio-Luxembourg will hold an international wireless show from June 22nd to 29th, manufacturers of all countries being invited to exhibit. Communications should be addressed to Association Radio-Luxembourg, 28, rue Beaumont, Luxembourg-Ville.

B 15

ALL IN USE ?

According to a Soviet message received by a Paris newspaper, there are 14 million wireless receivers distributed throughout Russia.

○○○○

I.E.E. ANNUAL MEETING.

The annual general meeting of the Institution of Electrical Engineers will be held to-morrow (Thursday) at 6 p.m. at the Institution, Savoy Place, W.C.2.

○○○○

SHORT WAVES IN THE DESERT.

The time when travellers marooned in the desert will be able to summon assistance by means of emergency telephone or telegraph boxes is suggested by the news of the early establishment of a wireless network in the Libyan desert. According to present plans, short-wave stations working on a fixed wavelength and capable of

being operated by unskilled persons are to be erected at the principal oases, for communication with radio headquarters at Cairo.

Whether telegraphy or telephony shall be employed has yet to be decided; if the former were adopted it is probable that unskilled operators would be able to transmit the necessary distress call merely by turning a handle, which would actuate a relay.

○○○○

THE U.S. RADIO TRUST.

Opposition to the proposed new American radio merger appears to be dying down. When the plans for amalgamation of the General Electric and Westinghouse concerns with the Radio Corporation of America were first announced, the anti-trust party in the Senate endeavoured to



TELEARCHICS IN JAPAN. A system of distant control by wireless has been invented by an officer in the Japanese Army. The picture shows a recent demonstration of a wireless-controlled tank in the Hibiya Park, Tokio.

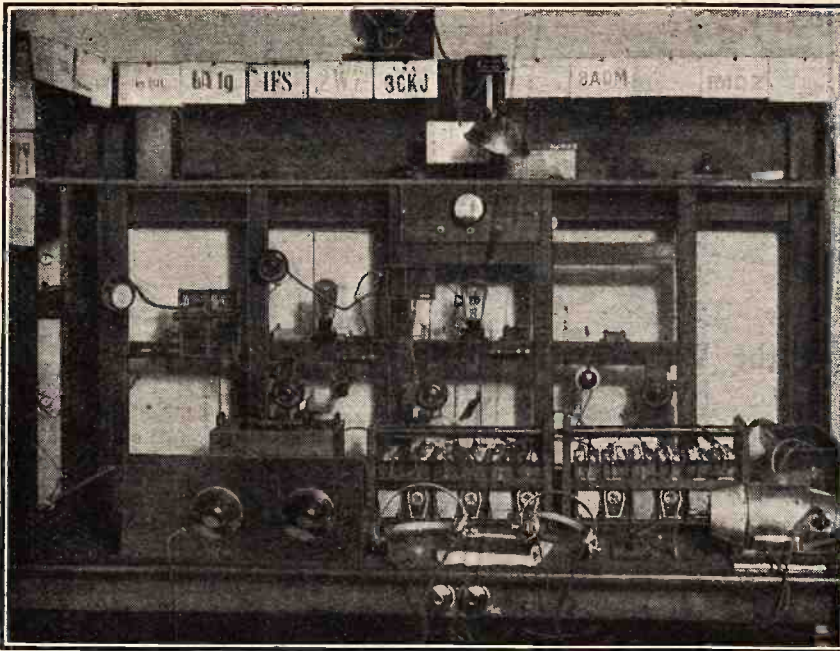

IRELAND'S FINEST AMATEUR TRANSMITTER. EI3B, the transmitter at 12, Trinity Street, Dublin, owned by the Wireless Society of Ireland. The station won the first place in the Irish Free State in the recent international tests organised by the American Radio Relay League.

hasten the reading of a new communications Bill aimed directly at alleged monopolistic practices of the R.C.A. We understand, however, that the companies are proceeding with their plans, not having met with any definite obstacle.

The scheme represents one of the biggest mergers in the history of wireless.

A STATIC TOURNAMENT.

A tournament taking the form of a "radio parasite" hunt is being inaugurated by the radio club at Fourmiers, in

the Department du Nord, France. The first-prize winner will be the club member who in one month tracks the largest number of interference producers, including electric motors, domestic appliances, and oscillating receivers.

AMATEURS IN IRELAND.

We understand that the Wireless Society of Ireland is considering a big extension of its activities by the establishment of branches in many towns and districts throughout the Irish Free State.

Radio and the Upper Atmosphere.

Mr. G. P. Gowland, A.R.C.S., B.Sc., recently gave a lecture on "The Upper Atmosphere" before the Croydon Wireless and Physical Society. The lecturer dwelt at some length upon wireless questions. The theory of fading, skip distance, and other phenomena was given, and throughout every effort was made to give a true picture of the phenomena involved. It was seen that contributions from a varied collection of sources all fitted together to allow us to understand to some extent what is happening in that part of the atmosphere which is far outside our ordinary experience.

Visitors are heartily welcomed to any of the meetings.

Particulars, etc., may be obtained from the Hon. Secretary, Mr. H. T. P. Gee, Staple House, 51-52, Chancery Lane, London, W.C.2

The Power Stage.

"The Use of Power Valves" was the subject of a lecture given at the last meeting of the North Middlesex Radio Society by Mr. G. Parr, of the Edison Swan Co.

The lecturer treated the subject very fully, and by means of a small amount of mathematics and a large number of curves, demonstrated just what conditions must be fulfilled to get the best out of any power valve. Many people, said Mr. Parr, can get results from an amplifier which are pleasing to the ear, but usually the valve is worked in a very inefficient way. He showed, by means of the anode current-anode volts curve, the effects on the output of varying the impedance in circuit with the power valve.

Causes of distortion were readily seen from

THE RADIO ACROSTIC.

We print below the solution of the double acrostic contributed by a reader to our issue of April 30th:—

* K R
I nductanc E
L ew C(os).
O - V - O
M ete R
A D
G rid-circui T
F ultograp H
O scillato - R
(F)U s E
R esistanc E

* Correctly placed = RK.

o o o o

POWER SURPLUS IN PARIS.

Anxiety is felt by Paris listeners in regard to the enthusiasm of the Post Office in raising the power of the P.T.T. station while simultaneously increasing the height of its mast, writes our Paris correspondent. Listeners plead that there is already enough disturbance in the Parisian ether, and are not inclined to accept the official explanation that the improvement has been in preparation for the last two years!

o o o o

HILVERSUM AND HUIZEN.

The frequent wavelength exchanges between Hilversum and Huizen are apt to mystify the British listener, who is often at a loss to know which station is transmitting at any given moment. We are now indebted to the authorities at Hilversum for details regarding the summer transmissions.

Huizen is at present transmitting on 1,875 metres, while Hilversum operates on 298 metres during the day and on 1,017 metres after 6 p.m. On August 2nd, however, the two stations will make a complete exchange. The alteration takes place every three months.

CLUB NEWS.

the explanation given; an actual example of the distortion produced in the output by operating partly on the curved portion instead of on the straight portion of the "characteristic

curve" had been worked out by the lecturer and graphically illustrated.

The lecture was followed by a demonstration with Mr. Parr's own amplifier, which was used to reproduce a representative collection of gramophone records.

Hon. Secretary, Mr. E. H. Laister, "Windflowers," Church Hill, N.21.

o o o o

Mains v. Batteries.

The subject of A.C. and D.C. mains versus battery operation was the basis of an interesting debate at the last meeting of Slade Radio (Birmingham). Mr. N. B. Simmonds and Mr. R. Heaton spoke in favour of batteries, while Mr. C. Smart (A.C.) and Mr. R. W. Lawrence (D.C.) were in favour of mains.

The battery champions argued that, for the amateur experimenter, battery sets seem preferable owing to the fact that they can be altered very easily, whereas alterations to mains sets mean practically a total scrapping and re-designing.

The mains exponents contended that for the user who has no interest beyond that of merely listening mains sets are certainly much easier to install and operate.

After summing up, Mr. A. Freeman, the chairman, gave it as his personal opinion that battery sets are as efficient as mains and are still doing good work, especially in country districts. He considered, however, that in three years' time battery sets would constitute only 25 per cent. of the total number in use.

Particulars of the Society may be had on application to the Hon. Secretary, 110, Hillaries Road, Gravelly Hill, Birmingham.

FORTHCOMING EVENTS.

WEDNESDAY, MAY 14th.

Golders Green and Hendon Radio Society.—At 8.15 p.m. At the Club House, Willisfield Way. Informal evening.

Muswell Hill and District Radio Society.—At 8 p.m. At Tollington School, Tetherdown, N.10. Lecture and demonstration by Mr. Goward (of Aeonic Radio, Ltd.).

THURSDAY, MAY 15th.

Slade Radio (Birmingham).—At the Parochial Hall, Broomfield Road, Erdington. Lecture: "Resistance and Power Transformers," by Mr. Parkinson (of Messrs. Valey).

FRIDAY, MAY 16th.

Radio Experimental Society of Manchester. At 8, Water Street, Manchester. Lecture by Dr. F. St. John.

SATURDAY, MAY 17th.

Visit of North London Radio Societies to the Wembley Research Laboratories of the G.E.C. (Meet at entrance at 2.30 p.m.)



My Household Set

This interesting contribution from a reader has been prompted by the description of Captain Ian Fraser's Household Set in "The Wireless World" of Nov. 13th last.

By H. FLEETWOOD WALKER.

IN the household wireless outfit to be described the points sought for in its design have been ease of control and quality of reproduction. The instrument consists of a detector and two L.F. circuit driving a moving-coil speaker, and is situated on the ground floor, with the speaker three floors above. The switching arrangement has been developed to enable the set to be switched on and off, the programme to be changed, and the volume controlled, from the loud speaker.

The method by which pre-detector volume control is obtained will be understood when it is explained that the aerial lead-in runs down outside the window of the room where the loud speaker is situated.

The lead-in is divided, the cut ends being brought in through the window, spaced six inches apart by ebonite strips, to a 0.0003 mfd. variable condenser, mounted on the loud speaker baffle. Variation of this capacity gives complete control of volume. The lower portion of the lead-in is taken down to the set on the basement floor. The range of volume control obtainable depends upon the value of the fixed series aerial condenser used in the set—0.001 mfd. giving the best range. If a smaller capacity be used the range of control is limited. Remote volume control by this method makes it possible to correct any overloading of the last valve due to variation of signal strength without the trouble of going downstairs to the set.

The set is turned on and off by means of a single push-button controlling a "Gamage" remote-control switch, which breaks the L.T. positive lead. The high-tension circuit is not broken, as a D.C. mains eliminator is employed using series resistances for each anode feed instead of a potential divider. Consequently, no plate current is passed when the filaments are cold.

The remote control is so arranged that each time the set is switched on the programme is changed, i.e., Off, On Brookmans Park 356 metres; Off, On Brookmans Park 261 metres, and so on. The wavelength change is carried out by adding capacities to each of the tuning condensers in the set of a correct value to raise the wavelength from 261 to 356 metres. A second "Gamage" remote-control switch was obtained having

two fixed contacts brought out to separate terminals and a revolving contact connecting to the other two when the 356-metre programme is being received, i.e., once in each cycle of four movements. A careful inspection of Fig. 1 shows that the lower ends of the two tuned coils are at different potentials. This necessitated an alteration in the tuning circuit, by means of which the lower ends of the tuned coils are made common and joined to the moving contact on the relay (Fig. 2 (1)). The additional (wavelength raising) condensers were connected to the fixed contacts of the relay on the one side and to the aerial and grid ends of the tuning coils on the other (Fig. 2 (2), (3)).

Methods of Coupling.

The anode-bend detector is resistance-coupled to the first L.F. valve, both having an amplification factor of 15 and an impedance of 7,500 ohms. The first L.F. valve is followed by a Ferranti A.F.5 transformer, the primary of which is fed through a 40,000-ohm resistance, and a 4-mfd. condenser. This resistance-condenser feed is employed to avoid the drop in primary inductance from 200 to 120 henrys due to the 4 mA. D.C. feed to the preceding valve, and gives an audible improvement in quality below 50 cycles.

The output stage consists of an L.S.6a valve, working on just over 400 volts H.T., biased at -108 volts, a complete decoupling system being applied to its grid circuit (Fig. 3). This allows the bias value to be adjusted without switching off the H.T., the 2-mfd. condenser holding its charge during the adjustment and keeping the grid negative, and also any small variations in the voltage of the dry batteries used for

biasing to be smoothed out. The loud speaker, an R.K. reproducer with a six-inch plain cone, has a low-resistance moving coil, and is coupled to the last valve through an output transformer. The B.T.-H. 15-1 output transformer, supplied with this speaker, when passing the plate current of the L.S.6a (63 mA.), is working so near to the saturation point that an attempt to choke feed it was made, using a heavy choke with a working inductance of 30 henrys, and a 6-mfd.

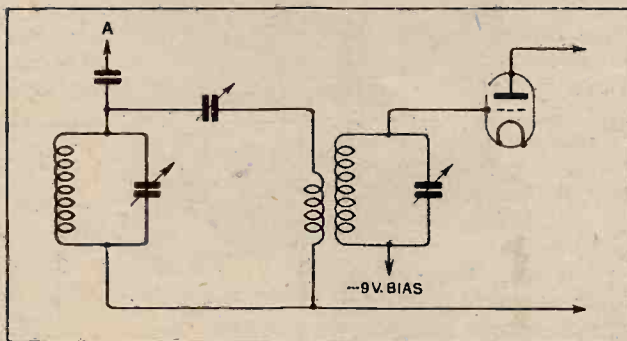

Fig. 1.—The lower end of the two tuned coils being at different potentials necessitated a common lead to the moving contact of the relay (Fig. 2 (1)).

My Household Set.—

coupling condenser. Used in this manner saturation of the transformer was avoided, but as there was a noticeable falling off in the brilliance of reproduction in the upper register a special output transformer was designed with a core section of 1in. x 1½in. (No. 4 stampings supplied by W. B. Savage, of 149, Bishopsgate). This was wound with silk-covered enamelled wire, the primary had 1,300 turns of No. 26 gauge (resistance 24 ohms), and the secondary 68 turns of No. 20 (resistance 0.4 ohms), the number of turns being calculated to match valve and moving-coil impedance and

voltage rise of the cells, thus enabling them to be left on charge indefinitely without harm.

The contacts on the change-over switch are connected as follows:—

Fixed Contact.	Moving Contact.	Fixed Contact.
1. Grid P.625A.	AF5c. Secondary grid.	Grid L.S.6a.
2. Bias—35.	AF5c. Secondary bias.	Bias —108 v.
3. Filament.	L.T. positive.	Filament.
4. Plate P.625a.	Output transformer primary.	Plate L.S.6a.
5. +200 eliminator.	Output transformer primary.	+200 v. accumulator.
6. 100 w. bulb.	H.T. accumulator minus.	+200 v. eliminator.
7. Mains plus.	H.T. accumulator + 200.	+200 v. accumulator.

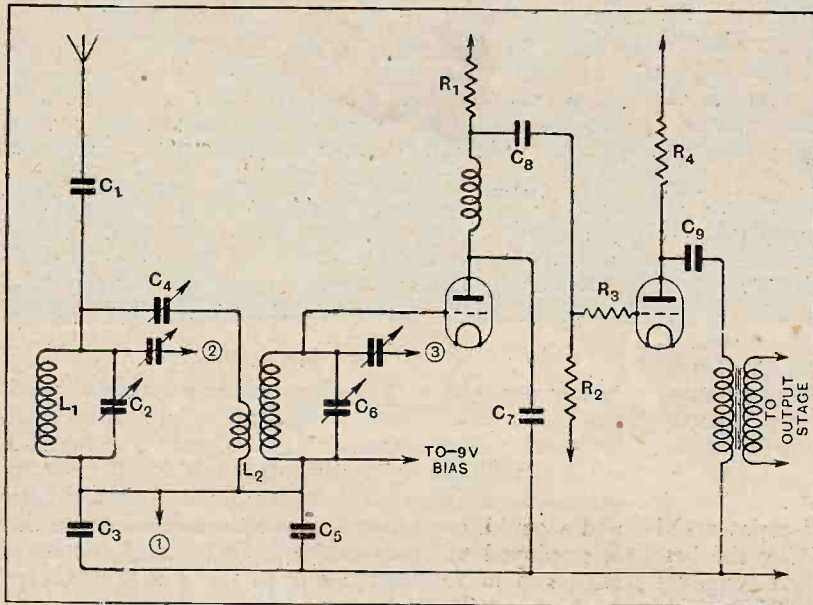

Fig. 2.—Showing the connections to the remote control relay. Additional wave-length raising condensers are connected to the fixed contacts of the relay on the one side and to the aerial and grid-ends of the tuning coils on the other (2) and (3).

afterwards checked by trial and error to find the optimum number, which proved to be as above. This larger core enables a high primary inductance to be obtained with comparatively few turns, thus avoiding saturation with the maximum value of anode current, whilst the low resistance avoids voltage drop; theoretically saturation is not produced until the primary is passing 150 milliamps.

An alternative output stage is provided to save filament current (L.S.6a taking 1.6 amps.) when great volume is not required. This consists of a P.625a valve with 200 volts H.T., the change over being carried out by a single knob on the set panel. This switch is a well-insulated 7-pole double-throw type and switches the L.S.6a, on 400 volts and -108 bias, over to the P.625a, on 200 volts H.T. and -35 bias, with one movement. The contacts are so arranged that when the smaller valve is being used the bank of 200-volt H.T. accumulators used in series with the mains to obtain 400 volts for the L.S.6a are placed on charge. The resistance used for charging is a 100-watt 220-volt half-watt lamp; this passes 120 mA. when the accumulators are discharged and only 2 mA. at the end of charge, the current falling owing to the

The H.T. battery eliminator has a single stage filter with a 20-henry choke in the common negative lead, as the mains have an earthed positive. Separate chokes with voltage-dropping resistances (100,000 ohms detector, 40,000 ohms first L.F.) and 4-mfd. 500-volt test by-pass condensers are provided for the first two valves, the last stage being supplied from the + mains direct and having a 10-mfd. 1,000-volt test condenser from the H.T. plus side of the output transformer to the filament negative. Two 2-volt 0.3 amp. flashlamp bulbs are fitted on the mains side of the apparatus as fuses.

A P.625a was chosen as the smaller output valve rather than a P.625 (impedance 2,500 ohms) on account of its low impedance (1,600 ohms), as it is used with the output transformer designed for the L.S.6a (1,300 ohms), thus obtaining better matching.

The loud speaker has recently been compared with the new R.K. 10in. corrugated cone in similar baffles of 1in. oak, 3ft. 6in. square. On this set the larger cone gives slightly greater volume for a given input and is not so sensitive to

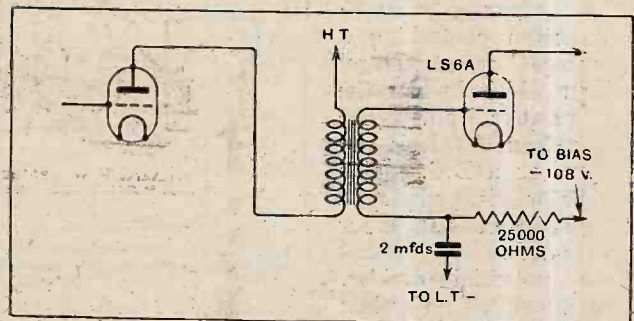

Fig. 3.—The output stage showing the method of applying the decoupling system to the grid circuit, permitting changes in grid bias value without switching off the H.T.

valve overloading. Thus overloading easily audible on the 6in. cone is not heard on switching over to the larger model.

This outfit has sufficient power to reproduce a piano in a large room at its natural volume without a trace of blasting or audible frequency distortion.

WIRELESS WORLD



LABORATORY TESTS

A Review of Manufacturers' Recent Products.

VARLEY STANDARD L.F. CHOKE.

This component is intended for use in all cases where a relatively heavy current is flowing, such as in the smoothing circuits of a battery eliminator supplying a power amplifier with H.T. Many other applications, of course, come within its scope, but they are far too numerous for detailed description here. The rated inductance is 20 henrys and the maximum current that it will handle is given as 140 mA. Since the inductance will vary according to the magnitude of the D.C. current passing through the choke, some measurements were made with a view to ascertaining the behaviour of the choke under the influence of D.C. excitation from 0 to 100 milliamps. The inductance values obtained are tabulated below:—

INDUCTANCE AT 50 CYCLES WHEN CARRYING D.C.

Current in mA.	Inductance in Henrys.
0	31.5
20	24.5
40	21
60	18.8
80	17.2
100	15.8

The nominal inductance of 20 henrys was shown by the sample tested when 48 milliamps were flowing in the winding.



Varley 20-henry standard L.F. choke for use in power amplifiers. Currents up to 140 mA. can be passed through the winding.

It is important that a choke of this type should have a low ohmic resistance, since otherwise a serious voltage loss will occur when large currents are passing. This feature is exhibited in the Varley

product, as its measured D.C. resistance was only 230 ohms. The makers give it as 240 ohms.

The choke is housed in an attractive black bakelite-case with the two terminals conveniently placed. A soldering tag is provided for earthing the core where necessary. The makers are Varley, Kingsway House, 103, Kingsway, London, W.C.2, and the price is £1.

o o o o

**P.M. CABINET SPEAKER,
Type "K."**

This model is a recent addition to the well-known range of loud speakers made by the Mullard Wireless Service Co., Ltd., "Mullard House," Charing Cross



Mullard P.M. cabinet loud speaker, type "K," fitted with a balanced armature unit provided with a tapped winding.

Road, London, W.C.2, and is offered at the attractive price of £6 15s. The operating mechanism consists of a balanced armature movement driving a cone 13in. in diameter, the whole being housed in a polished oak cabinet measuring 19in. square. The front fret has been designed to offer the minimum of obstruction to the sound-waves, and the back is acoustically open, also, to prevent cabinet resonance. Both back and front apertures are covered by silk screens to prevent dust getting into the cabinet and impeding the movement of the vibrating parts. The winding on the unit is so gener-

ously proportioned that a D.C. current of 25 milliamperes can be passed through it. The speaker may, therefore, be connected direct in the anode circuit of a power output valve if desired, provided other considerations do not demand interposing a filter circuit. At the back of the cabinet are three sockets which connect to the two ends, and to a tapping on the speech coil, respectively. These give the choice of three different impedances for the purpose of matching the loud speaker to the output valve. The two outside sockets were found to show a D.C. resistance of 1,700 ohms; and between each end socket and the centre resistances of 1,250 ohms and 450 ohms were obtained. The makers give the resistance values as 1,800, 1,200 and 600 ohms respectively.

A practical test was made, using a super power output valve of 1,750 ohms A.C. resistance. Some interesting effects were obtained by changing from one resistance value of the speaker to another. With the whole of the coil in circuit, quite a good balance between the upper and the lower register was obtained, the volume being more than required to fill a room of average size. With the lowest resistance available there was a noticeable absence of bass and an abundance of treble. The intermediate value gave quite pleasing results, although the upper tones somewhat overshadowed the lower frequencies. The maximum resistance would appear to be required with most valves other than those possessing a very low A.C. resistance.

o o o o



Rigby and Woolfenden's "de Luxe" screening cabinet.

SCREENING CABINETS.

When constructing a receiver which is intended to afford really high H.F. amplification it is reassuring definitely to know that instability cannot be

caused by imperfect isolation of the various circuits. Screening is still one of the most serious practical obstacles in the way of the amateur who sets out to achieve exceptional sensitivity, and any

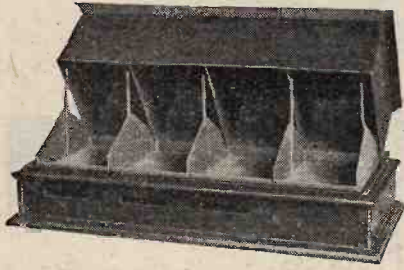

"Standard" screening cabinet with cover partly removed, showing studs.

contribution that tends to reduce his difficulties is to be welcomed.

The new metal cabinets produced by Messrs. Rigby and Woolfenden, of Sun Works, Millnrow Road, Rochdale, Lancs, are designed in such a way that direct magnetic or capacitive interaction between grid and plate circuits is rendered impossible. They are built on the general lines of those described in this journal, and used for such receivers as the "1930 Everyman Four" and the "Kilo-Mag Four." In both these sets condensers with vertical spindles and edgewise control dials were fitted.

Provision has been made for positive electrical sealing of the joints between cover and base by inserting flexible tubes of brass gauze in the channels of the metal tray. The edges of the cover and of its transverse partitions are forced into inti-

mate metallic contact with this flexible packing material by tightening wing-nuts on the upper ends of threaded studs, which protrude through the cover, and are secured at their lower ends to the tray. A false top is provided to conceal the wing-nuts.

These cabinets are made in various styles. The "de Luxe" model, with ornamental moulding round cover and base, and with a raised plinth, costs £7 10s. The "Standard" cabinet, without ornamentation, is sold at £4 15s. The metal covers are finished in brown to match the hardwood bases. Metal containers, without woodwork, finished in glossy brown, may be had for £3 5s. All the cabinets have four compartments, each measuring 7in. high, 9½in. deep, and 7in. wide, and so are suitable for 3-4, or even 5-valve receivers of the more ambitious kind.

TWO-WAY TELEVISION.

Bell Telephone System Demonstrated.

ALTHOUGH two-way television may seem a logical development of the one-way tests, new problems are encountered. Many obstacles were overcome in the demonstration given by the American Telephone and Telegraph Company in New York on April 9th, but, in the words of the company's vice-president, Mr. Frank B. Jewett, "the terminal apparatus is still inherently complicated and expensive."

The occasion was the first demonstration to the Press of an experimental two-way television service by wire between the Telephone Company's building at 195, Broadway, and the Bell Telephone Laboratories at 463, West Street. Special telephone booths were installed in these buildings and equipped with television transmitters and receivers.

The general appearance of these "Ikonophone" booths, as they are called, is indicated in the photograph on this page. The speaker seats himself before the transmitter, his own face being rapidly scanned by a mild beam of blue light, while he observes in the receiving lens the features of the person with whom

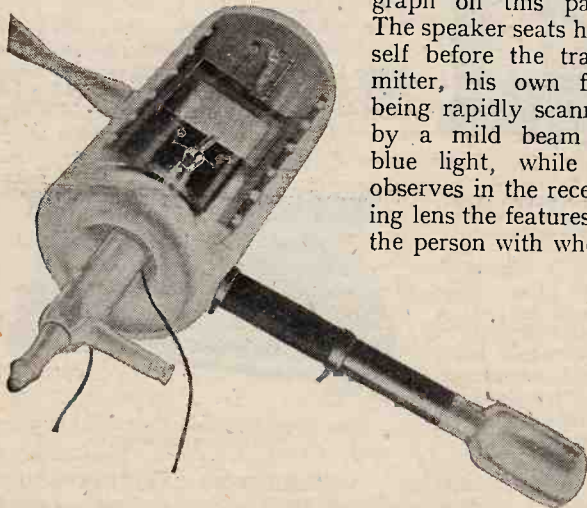

One of the water-cooled neon tubes used in the reception of images by the Bell television system.

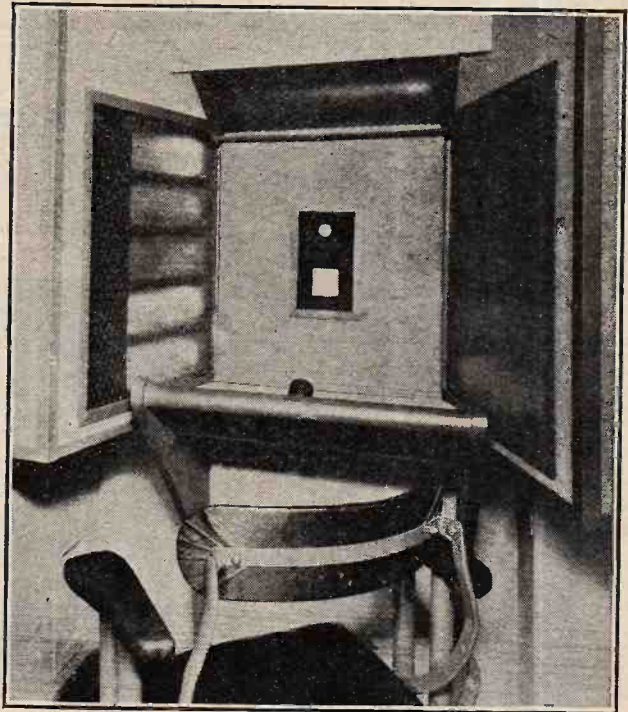

The "Ikonophone" booth as used in the tests. The distant image makes its appearance in the lower aperture, while from the point just above it the blue scanning beam is projected on the face of the speaker.

he is conversing. It is worth mentioning that speakers can never see each other literally "eye to eye" for the simple reason that when one is looking into the eyes of the other, his glance is slightly averted from the transmitting lens. To the other person, therefore, he appears to be looking down, or up, as the case may be.

The television booths are lighted with a dim orange light to which the photo-electric cells are insensitive. The observer at once notices the absence of the ordinary telephone mouthpiece, which, if used, would partly

Two-way Television.—

conceal his features from the distant watcher. Telephone transmitters are accordingly concealed in the sides of the booth.

The received image is formed eighteen times a second, and is of the familiar black and pink type peculiar to neon tube reception, but the picture is now twice as large as that obtained in the Bell Telephone Company's demonstration in 1927.

The photo-electric cells have been much improved in sensitiveness, and give rise to about ten times the current for the same amount of light as did those developed for the earlier demonstration. This increased sensitivity and the use of the blue scanning beam have made possible the reduction of the dazzle and glare which occurred to a certain extent in the earlier forms of apparatus. The person whose image is being transmitted is, therefore, less conscious of the fact that his face is being swept eighteen times a second by a scanning beam of light; and the beam is not bright enough to interfere with his seeing the image of the person to whom he is talking. The increased area and detail of the image necessitate the use of a wide band of frequencies, and the circuits between the Broadway and West Street buildings have been adapted to the

transmission of a frequency band of forty kilocycles. Instead of the ordinary microphone transmitter, use is made of a condenser-microphone. The receiver is a small loud speaker carefully placed in the best position to avoid talking into the transmitter. To prevent

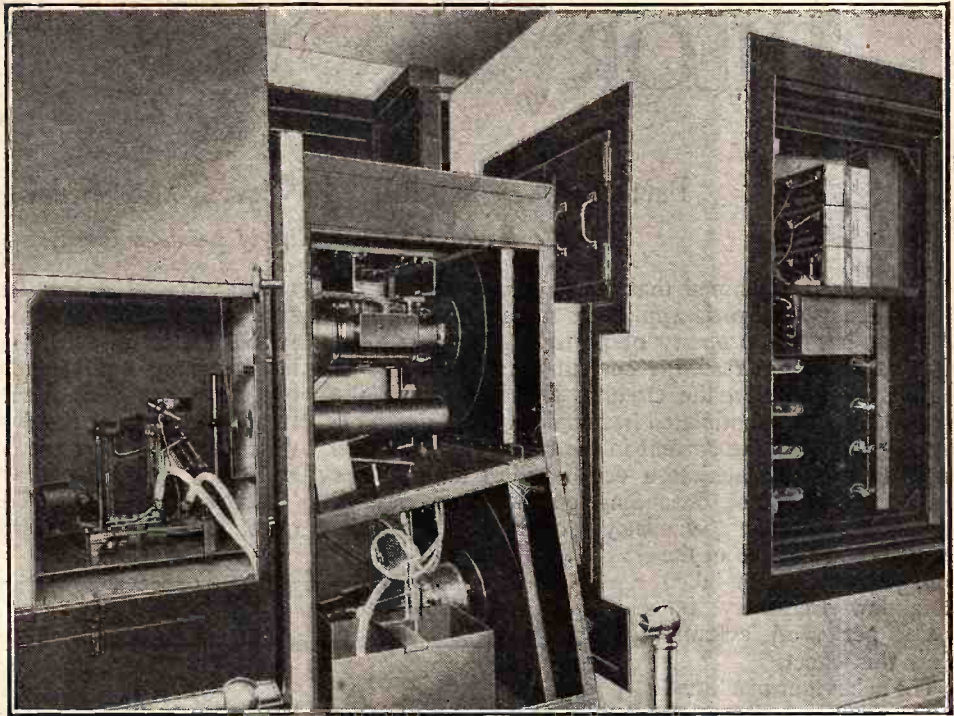

Two-way television equipment. The terminals of the photo-electric cells are seen on the right. In the centre are the scanning discs for transmitting and receiving, while on the left is the source of light.

the sound from the loud speaker from reaching the transmitter by reflection, the walls have been acoustically treated, and the entire booth is of careful sound-proof construction.

Vagaries of 7 M.C. Working.

G6PP, writing from Cricklewood, N.W.2, on April 23rd, comments on the extraordinary conditions which had prevailed for the past fortnight in working on the 7 megacycle (42 metre) waveband. He has kept up a regular schedule for nearly two years with G6YL at Morpeth, Northumberland, and G2ZC in Jersey, but during the fortnight in question communication with these stations has failed three times in succession. G6YL and G2ZC were able to establish communication, but G6PP was unable to hear the faintest sign of either of them, nor they of him. This type of skip-distance might be expected on 14 MC., but is unusual on the longer wavelength. Both G6PP and G2ZC attribute the phenomenon to the approaching sun-spot minimum cycle, and believe that any contact under 700 miles will for a time be impossible on 7 megacycles. We shall be interested to hear the experiences of other amateurs working on this waveband.

TRANSMITTERS' NOTES.

The 14 Megacycle Band in Ceylon.

News from Ceylon dated April 12th states that difficulty has been experienced there with the 14 MC. waveband. Signals from Europe have come through, but those from Australia and Africa have been almost entirely cut off, though VK6AG, of Perth, Western Australia, established two-way telephony with VS7AP in Colombo; his signals were, however, subject to rapid fading. Later, when he was inaudible in Ceylon, he was evidently being received on the Continent, as German amateurs were overheard calling him.

Is Amateur Transmission Declining?

We have frequently commented on the lack of news of any general interest which reaches us concerning the doings of British

transmitters. Possibly, it is felt that, having established communication with every part of this world, there is nothing worthy of record until two-way working with Mars has been accomplished. This dearth of news does not seem peculiar to Great Britain. Many of our foreign contemporaries also complain of the scarcity of reports from amateurs and, indeed, it must candidly be confessed that many that are printed are not of any great interest. We have before us a South African contemporary, in which we find—after deleting superfluous "OM's" (the Order of Merit must be very common in the Cape) and reducing the quaint jargon to intelligible English—that the Official Correspondent of nearly every district begins his report with a lamentation on lack of "dope." We gather that a new Hon. Secretary has been appointed in the Cape Midland and Eastern District, and that amateurs in the neighbourhood of Port Elizabeth hope that he will infuse fresh vigour and order into their activities.

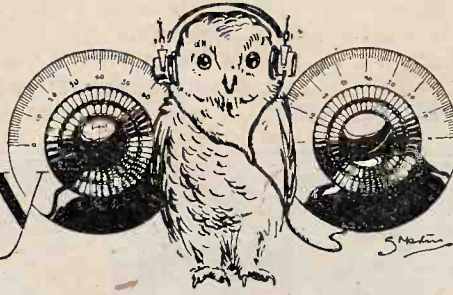
WIRELESS
THEORY

SIMPLIFIED

By S. O. PEARSON,
B.Sc., A.M.I.E.E.

Part XXX.—Modulated Waves and Sidebands.

(Continued from page 492 of previous issue.)

IT has been explained that when a modulated high-frequency voltage is applied to a tuned circuit, the latter has the property of partly damping out the modulation in the resulting current oscillations due to the stored energy in the circuit. For instance, if the applied voltage is modulated harmonically to a depth of, say, 50 per cent., the current in the tuned circuit will be found to be modulated to a depth of less than 50 per cent., the difference depending on the frequency of modulation and the "efficiency" of the tuned circuit. Oscillograph records of the voltage and current taken at a low frequency (50 cycles per sec.) actually show this effect.

The behaviour of a tuned circuit is very much simpler to deal with theoretically for oscillations of constant amplitude and, fortunately from this point of view, a high-frequency wave which is modulated periodically at an audio-frequency can be resolved into a number of high-frequency component waves, each having constant amplitude and frequency, the sum of these waves giving the modulated wave in question. The process is similar to that already described in connection with the resolution of a complex low-frequency wave into a fundamental sine wave and a series of harmonics. But in the present case it will be shown that we do not obtain a fundamental wave and harmonics whose frequencies are exact multiples of the fundamental frequency, but a fundamental high-frequency wave, equal in every respect to the unmodulated carrier wave, and a series of waves whose frequencies depart by a small percentage only from that of the carrier.

If we write down the equation for a high-frequency wave modulated so that its amplitude varies about the

mean value at a low frequency according to a pure sine law in the manner already explained, it is a fairly simple matter to show mathematically that this modulated wave is equivalent to the sum of *three* high-frequency waves each having a constant amplitude and frequency. One of these has a frequency equal to that which the carrier wave had before it was modulated, and this frequency is therefore referred to as the "carrier frequency." The other two waves have frequencies above and below that of the carrier wave respectively, and the difference between the frequency of either and that of the carrier is exactly equal to the frequency of modulation. For instance, if f is the carrier frequency in cycles per second, and F the low or note frequency of modulation, the three component waves of constant amplitude into which the modulated wave can be resolved will have frequencies of $(f+F)$, f , and $(f-F)$ cycles per second respectively. Of these $(f+F)$ is called the "upper side frequency," f the carrier frequency, and $(f-F)$ the "lower side frequency."

When transmitting a 1,000-cycle pure tone from a station working on 300 metres, the carrier frequency will be 1,000,000 cycles per second, and the two side frequencies will be 1,001,000 and 999,000 cycles per second respectively. In this case there is only one-tenth of 1 per cent. difference between either side frequency and the carrier frequency.

As the mathematical proof is beyond the present scope the same procedure will be adopted as was resorted to in dealing with complex low-frequency waves, namely, to assume two or more sine waves of suitable relative frequencies and to add them together graphically.

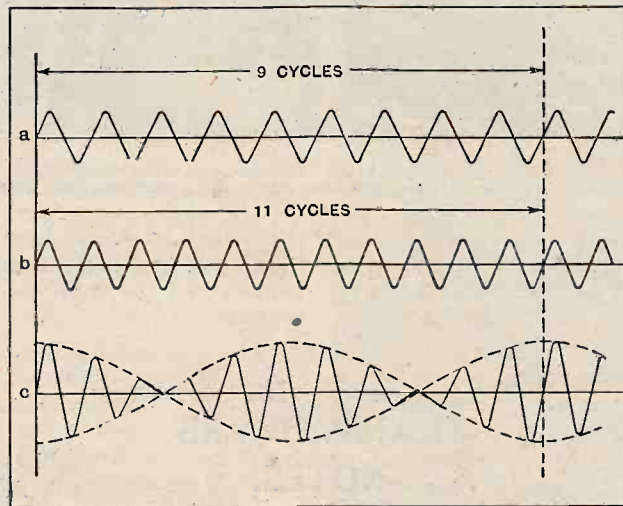

Fig. 1.—(a) and (b) are two sine waves of equal amplitude but of slightly different frequencies. Curve (c) is the result of adding (a) and (b) and is not a wave modulated in the normal manner. If f_1 and f_2 are the frequencies of (a) and (b), the low-frequency curves have a frequency of $\frac{1}{2}(f_2 - f_1)$ and the H.F. variation of (c) is $\frac{1}{2}(f_2 + f_1)$.

Wireless Theory Simplified.—

The first step is to determine the effects of adding together two sine waves of equal amplitude but having slightly different frequencies. Two such waves are represented by the curves (a) and (b) of Fig. 1. Suppose that wave (b) has a frequency higher than that of wave

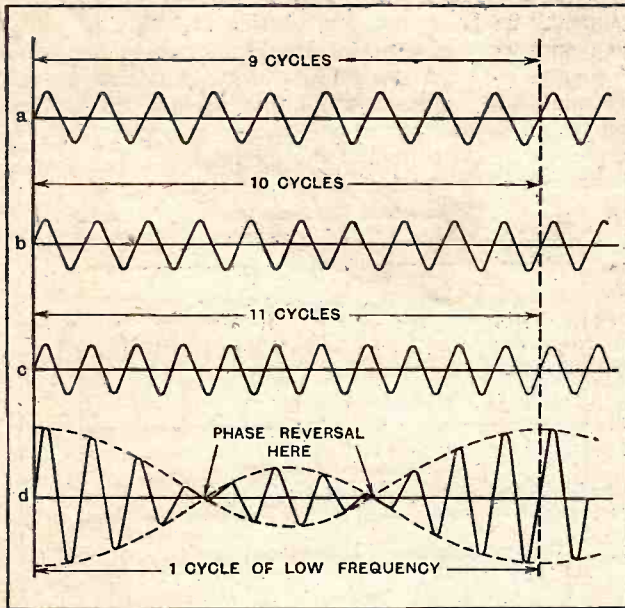

Fig. 2.—Curve (d) is obtained by adding together the three sine waves (a), (b) and (c), where (b) has a frequency midway between those of (a) and (c). A phase reversal occurs in the resultant wave and this is what would occur if a high-frequency oscillation could be modulated to a depth greater than 100%.

(a) to such a degree that for every 9 complete cycles of (a) there will be 11 complete cycles of (b). The amplitudes are made equal for a reason which will be appreciated later. If the two sine waves are drawn accurately and if the simultaneous values at various instants along the time base are carefully measured and added together, and the sum then plotted as a new curve, the resulting wave will be found similar to that shown at (c) in Fig. 1. This is clearly a high-frequency wave whose amplitude is undergoing periodic variation of some description, but it does not conform to the conditions required for the transmission of a pure tone. For when such a wave is rectified the resulting low-frequency pulsations will not obey the sine law. It will be noted that although the broken-line curves enclosing the high-frequency wave are actually sine-shaped waves, they are symmetrically placed about the zero line, and cross each other. The condition required for ordinary modulation is that these two low-frequency curves shall not cross each other.

It will be seen from Fig. 1 that the resultant wave (c) has a "frequency" midway between the frequencies of the two component waves, and that a complete phase reversal occurs every time the wave passes through the point of zero amplitude. The wave is one whose amplitude varies about the zero axis according to a sine law, and which, therefore, varies between a maximum positive value and a maximum negative value, this accounting for the phase reversal of the high-frequency component.

By repeating the same process for two waves of unequal amplitude a rather more complicated result is obtained, and, like the first case, does not conform to the conditions of ordinary modulation. It follows, then, that a wave modulated harmonically cannot be resolved into two component waves.

Introducing a Middle Frequency.

Now let us consider the effect of introducing a third high-frequency wave whose frequency lies midway between those already considered in Fig. 1. Then, during 10 cycles of this new mid-frequency wave there will occur 9 cycles and 11 cycles respectively of the other two waves. These three high-frequency waves are shown at (a), (b) and (c) in Fig. 2. Wave (a) has a frequency 10 per cent. less than that of (b), and wave (c) a frequency 10 per cent. higher.

The sum of the three waves is given at (d), and comparing this with the resultant curve of Fig. 1, we see that the introduction of the intermediate-frequency wave has had the effect of moving the contour curves (shown in broken lines) in opposite directions away from the central axis by a distance exactly equal to the amplitude of the central wave (b); that is to say, the central axes of the low-frequency curves have been separated by a distance equal to twice the amplitude of the intermediate wave. However, they still cross each other, and there is still a portion of the high-frequency component of the resultant wave which is reversed in phase.

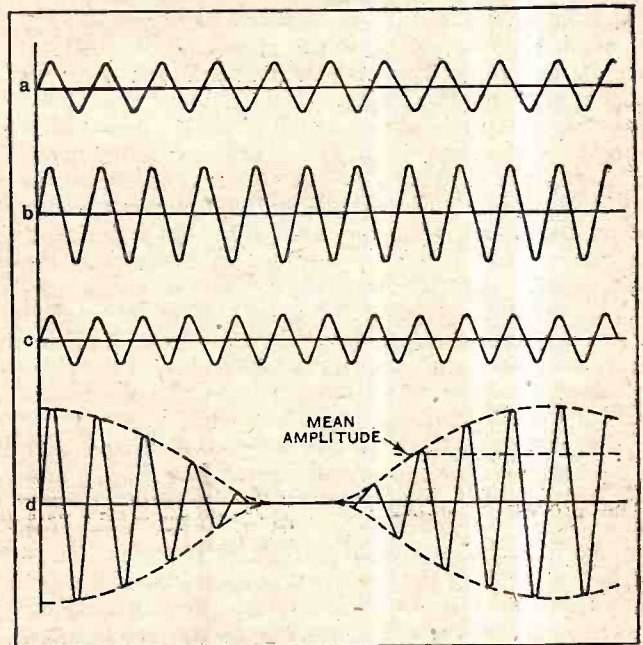

Fig. 3.—When the intermediate frequency wave (b) has double the amplitude of (a) or (c) the resultant wave (d) is one modulated to a depth of 100%. The "frequency" and mean amplitude of (d) are equal to those of (b).

This is the phenomenon which would occur if a high-frequency oscillation could be modulated to a depth greater than 100 per cent. It will be seen also that the resultant wave has a "frequency" equal to that of curve (b).

Wireless Theory Simplified.—

Having ascertained that the presence of the central wave (*b*) has the effect of separating the axes of the low-frequency curves by a distance equal to twice the amplitude of (*b*) it follows at once that by making the amplitude of the central wave just equal to twice that of each of the others, or equal to the sum of the other two, the low-frequency boundary curves will just not cross each other. Thus in Fig 3 curves (*a*) and (*c*) each have an amplitude equal to half that of the central wave (*b*), the respective frequencies being the same as before. The resultant wave at (*d*) is seen to be one whose amplitude varies between a maximum value and zero according to a simple sine law without any phase reversal occurring. In fact, the wave is one representing a high-frequency oscillation modulated harmonically to a depth of just 100 per cent. The mean value of the amplitude taken over a whole cycle of the low-frequency component is equal to the amplitude of the central component wave (*b*). The "frequency" of the modulated wave is also equal to that of the central wave, so that the latter is in every respect equal to the unmodulated carrier wave.

Shallow Modulation.

Before considering the question of relative frequencies it will be helpful if we determine the result of adding together the three component waves when the intermediate-frequency one has an amplitude greater than the sum of the amplitudes of the other two. Accordingly, in Fig. 4 at (*a*), (*b*) and (*c*), three waves have been drawn, in which (*b*) has four times the amplitude of either (*a*) or (*c*), the respective frequencies being the same as in the previous two cases. The resultant modulated wave found by adding together these three component waves is shown at (*d*) and in this case the depth of modulation is seen to be just 50 per cent., that is to say, the amplitude of the resultant high-frequency wave varies above and below the mean value by 50 per cent. In general, for a given percentage of modulation the amplitude of each of the side-frequency waves is one-half of this percentage of the amplitude of the central or carrier wave. For example, when the depth of modulation is 20 per cent., the amplitude of each of the side-frequency components will be 10 per cent. of the amplitude of the carrier frequency component.

Now as regards the difference between the frequencies of the component waves, it will be seen from Figs. 3 and 4 that during one complete cycle of the low-frequency curve, wave (*a*) passes through 9 cycles, wave (*b*) through 10 cycles, and wave (*c*) through 11 cycles. Thus during one cycle of the low-frequency variation wave (*a*) passes through just one cycle less than the intermediate wave (*b*), and wave (*c*) passes through one cycle more than (*b*). Therefore, if f is the frequency of the intermediate wave (the carrier frequency) and F the frequency of amplitude variation (the modulation frequency) of the modulated wave, then in one second wave (*a*) will pass through $f-F$ cycles and wave (*c*) through $f+F$ cycles.

From this it follows that a modulated wave whose basic frequency is f cycles per second, and whose low-frequency variation is F cycles per second, can be built up by adding to a high-frequency carrier wave of fre-

quency f two secondary waves having frequencies of $f-F$ and $f+F$ cycles per second respectively, and of equal amplitude. For the reasons given above, it is understood that the amplitude of each of the secondary waves does not exceed half that of the carrier wave.

Thus, by reversing the process, we may look upon a high-frequency wave modulated harmonically at a low frequency as being the combination of a central high-frequency wave of constant amplitude having the same frequency as the carrier wave, and two auxiliary waves of equal and constant amplitude having frequencies above and below that of the carrier respectively by a frequency equal to that of the modulation.

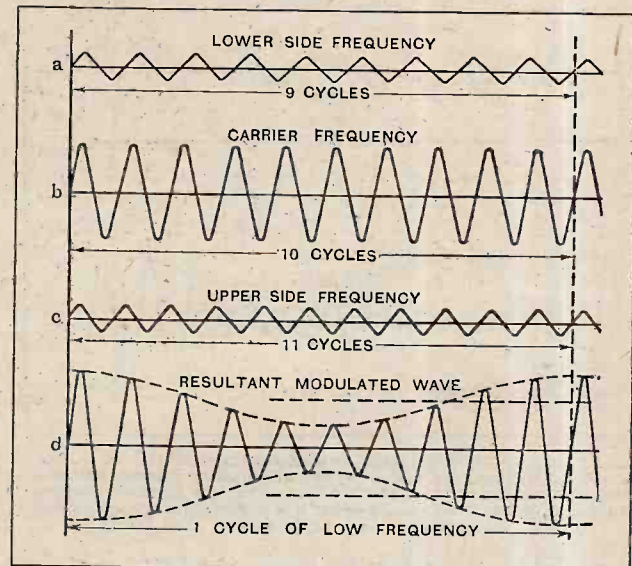

Fig. 4.—When the amplitude of the intermediate wave (*b*) is greater than the sum of the amplitudes of (*a*) and (*c*) the resultant wave is one modulated to a depth less than 100%. In this case the modulation is 50%. The low-frequency variation has a frequency equal to the difference in frequency between wave (*b*) and either (*a*) or (*c*).

This principle can be extended to meet the general case where a high-frequency wave is modulated according to the variations of a complex low-frequency wave as normally encountered in practice. The low-frequency wave itself is known to be equivalent to the sum of a fundamental sine wave and a number of harmonics, and so the modulated wave can be resolved into a carrier frequency and a number of pairs of side frequencies, one pair for the fundamental low-frequency wave and one pair for each of the harmonics. Thus, on each side of the carrier or basic frequency there will be a "band" of auxiliary component frequencies equal in number to the number of component low frequencies representing the actual low-frequency wave. The two ranges of auxiliary frequencies, one on each side of the carrier, are referred to as *sidebands*, and the width of each expressed in cycles per second is equal to the frequency of the highest harmonic of the low-frequency wave.

From the above aspects the ordinary theory of a tuned circuit relative to unmodulated waves can be applied to the case of modulated waves and the general effects on quality of reproduction and selectivity can easily be determined from the normal resonance curve.

(To be continued).

Timely Words for Northern Listeners.

Occasionally the London listener discovers that there is no alternative programme, and his disgust knows no bounds. Yet this is the almost regular lot of the Northern listener, whose only alternative — Daventry National — is usually sending out the same material as his local station.

Words of comfort from Mr. Edward Liveing, Northern Regional Director, have come only just in time to quell an outburst.

○○○○

What the Northern Regional Will Do.

Mr. Liveing radiates optimism regarding the Northern Regional station at Moorside Edge, which, he says, will be providing alternative programmes by the end of the year, with a service area far exceeding that of the transmitters at Brooklands Park.

Good signals should reach listeners in Derbyshire, most of Yorkshire, the nearer Welsh counties, parts of Lincolnshire and as far north as Westmorland.

○○○○

A Far-Flung Service Area.

Even Northumberland listeners who are prepared to take trouble with their sets will enjoy Northern Regional programmes, says Mr. Liveing, though they will not have to rely on these as the Newcastle relay transmitter will remain in operation.

○○○○

Criticism in Londonderry.

Mr. Liveing's fatherly words to his own children will have a tantalising effect in Northern Ireland, where listeners are beginning to feel neglected. Belfast was a good station according to the critical standards of two or three years ago, but from what Londonderry is now saying about it, one would imagine that the station had been erected in the early days of Queen Victoria.

○○○○

The Director-General Replies.

Sir John Reith has himself replied to a petition from Londonderry listeners who want a better service. The "D.G." states that it has not yet been found possible to provide Londonderry with the service it would like to have, but that solutions are being sought which will remove present difficulties.

○○○○

Worth Remembering.

Ulster listeners would do well to realise, however, that the existing Regional Scheme makes no provision for a twin-wave station at Belfast. All that is arranged for is a single-wave station with the same power as Brookmans Park. Ulster will also have to wait until the other Regional stations are completed.

○○○○

The Director of Programmes.

There have been rumours, which I am able to refute, that Mr. Roger Eckersley is about to relinquish his position as Director of Programmes in favour of Captain Cecil Graves. The facts are that Captain Graves, who has assisted Mr. Eckersley for several years, is now empowered to act for and represent his



By Our Special Correspondent.

chief in various details of programme direction. Mr. Eckersley, while retaining the directorship, will now be free to assume additional responsibilities.

○○○○

Those Bach Cantatas.

A friend who "likes Bach in moderation" asks me whether the B.B.C. is catering for any considerable number of listeners by broadcasting the Cantatas Sunday after Sunday. He actually makes the heretical suggestion that Sunday listeners are sated with Bach and would hold the composer in greater esteem if the cantatas were given at less frequent intervals.

○○○○

What Do You Think?

This is treading on dangerous ground. Bach lovers are sturdy fellows, ready to fight to the death, and I have no desire to offend. But even Bach lovers

FUTURE FEATURES.

National (261 and 1,554 metres).

MAY 18TH.—Religious service relayed from the City Temple.

MAY 19TH.—International concert relayed to and from Germany and Belgium.

MAY 20TH.—Samuel Pepys commemoration service relayed from St. Olave's Church, Hart Street, London.

MAY 21ST.—"The Wrecker," a play by Michael Talbot.

MAY 22ND.—Vaudeville programme.

MAY 23RD.—Special concert relayed from Queen's Hall.

MAY 24TH.—Empire Day programme.

London Regional.

MAY 18TH.—Military band concert.

MAY 19TH.—Instrumental concert.

MAY 20TH.—Covent Garden opera relay.

MAY 21ST.—Military band concert.

MAY 22ND.—Jubilee Festival of Guildhall School of Music. Orchestral concert relayed from Queen's Hall.

MAY 23RD.—"The Wrecker," a play by Michael Talbot.

MAY 24TH.—Military band concert.

Midland Regional.

MAY 19TH.—Fireside songs.

MAY 21ST.—Light orchestral concert.

MAY 22ND.—Symphony concert.

Cardiff.

MAY 21ST.—Opening of Laboratories at University College, Cardiff, by H.R.H. the Prince of Wales.

Manchester.

MAY 23RD.—Manchester University Jubilee Celebrations. Ceremony of Conferment of Honorary Degrees, relayed from Free Trade Hall, Manchester.

Glasgow.

MAY 20TH.—"King Cricket," a seasonable "review" (from Aberdeen).

Belfast.

MAY 23RD.—Irish folk song recital.

have admitted that the cantatas are uneven in quality (not surprising in view of their number), and this point might be borne in mind by the B.B.C. before deciding to transmit the entire series, which would probably require every Sunday between now and 1940.

Have readers any opinions on the matter?

○○○○

The 1930 "Proms."

Saturday, August 9th, will see Sir Henry Wood conducting the first of another season of Promenade Concerts at the Queen's Hall, under the direction of the B.B.C. The season will last eight weeks, the concluding concert being given on October 4th. The majority of the concerts will be broadcast.

○○○○

Winter Symphony Concerts.

After the Promenade Concerts comes a season of weekly symphony concerts, also at the Queen's Hall, and extending over a period of twenty-three weeks. Wednesdays, instead of Fridays, will be symphony concert nights, the opening night being Wednesday, October 15th.

I understand that the season's programme will adequately reflect the B.B.C.'s partiality for foreign conductors.

○○○○

The Albert Hall Again?

The recent performance of the Mahler Eighth Symphony drew such a large audience that the B.B.C. are wondering whether it would be advisable to engage the Albert Hall when a work of similar magnitude is next attempted.

Listeners will not object to this proposal, but there may be division of opinion among concert-goers who remember the famous Albert Hall echo effect during the B.B.C.'s 1926-27 series of symphony concerts. Fortunately, this effect (or defect) is not revealed by the microphone.

○○○○

In a Railway Signal Box.

"Diversions" to-morrow evening (Thursday) in the National programme will include a speedway meeting at Wembley Stadium, described by J. E. Hosking, and "The Nerve Centre of a Great Railway," relayed from Willesden Junction signal box.

○○○○

Prince George at the Microphone.

Prince George will open the Bristol Municipal Airport on May 31, and the programme, taken on the National wavelengths, will be relayed from the Bristol Airport, Whitchurch, Bristol. The Airport, which is half a mile from City boundary, is intended to be the new gateway of the West, and it is hoped shortly to arrange services to Dublin and also to the Continent.

○○○○

Another International Relay.

On May 19th the third International concert will be broadcast on the National wavelengths, with Belgium, Germany and Great Britain as contributors.

The composite programme will be in lighter vein than its predecessors, with music by representative composers.

CORRESPONDENCE.

The Editor does not hold himself responsible for the opinions of his correspondents.

Correspondence should be addressed to the Editor, "The Wireless World," Dorset House, Tudor Street, E.C.4, and must be accompanied by the writer's name and address.

MIDLAND PROGRAMMES.

Sir,—May I briefly reply to "Northerner"?

I only asked for the London Regional programme to be relayed through Manchester because I found, after two years hammering at the B.B.C., that we could not get "Northern Programmes." We shall get one in due course, but, as a temporary measure, we thought the London Regional better than nothing.

I might say that I believe, from information received, that Northern listeners did act on my request to a very large extent, and "Northerner" and the B.B.C. are the only people so far who have expressed their displeasure publicly.

LOUIS J. WOOD, Hon. Sec.,
The Halifax Wireless Club.

QUALITY AND THE LISTENER'S SET.

Sir,—It is amusing and at the same time, I admit, a little exasperating to find Mr. J. L. Greatorex, in your issue of March 12th, writing from London to deprecate expenditure on the improvement of land-lines and, by implication, giving the B.B.C. a certificate of comparative impeccability in the matter of transmission quality.

A listener in London, however, is hardly qualified to pass judgment on the average quality of B.B.C. transmissions. He has no experience whatever of common-wavelength transmission, none, to speak of, of wireless-link transmission, and little enough even of the ordinary transmission over long land-line, which is the usual channel of distribution from London to the provinces. The greater part—some 80 per cent.—of his entertainment comes to him by direct transmission over short or specially prepared land-line, and he is, therefore, in regard to quality of transmission, in the happy position of having nothing to complain about.

The condition of the provincial listener is nothing like as satisfactory. The surviving main stations, Belfast excepted, give only some 25 per cent. direct transmission, the balance being either by wireless-link or land-line. Transmission from the common-wave transmitters adds the serious defects peculiar to this system of working to those already contributed by a land-line connection or wireless-link.

Mr. Greatorex's disparagement of the average receiver is quite beside the mark. Criticism of B.B.C. transmissions is based on an experience of the different results obtained with the different types of transmission on one and the same receiver. And, as I have asserted before, perfection or elaboration in the receiving system is not needed to justify objection to the character of transmission.

Newcastle-on-Tyne.

K. McCORMACK.

NEW MOVING-COIL LOUD SPEAKER.

Sir,—In your issue of April 9th an article appeared relating to a loud speaker having a Balsa wood diaphragm. I heard the reproduction from this instrument at the recent Physical Society Exhibition. The bass register was lacking, relatively, and the upper register so prominent as to be, to me, aurally distressing. This would be due to resonances caused by the elasticity of the connection between the coil and diaphragm, i.e., concertina effect (see *The Wireless World*, October 17th, 1928, January 30th, April 10th, 1929). From Fig. 1 of the article (lower curve) the energy at 1,000 cycles and upwards is seen to be 100 times (20 decibels) that at 50 cycles. Obviously, this means a very powerful upper register which masks the bass and upsets the tonal balance of the average reproduction.

It is stated that the velocity of sound in Balsa wood is twenty times that in air. The velocity with which we are concerned in a diaphragm depends on the thickness and diameter, and is much less than that of the longitudinal velocity in Balsa *per se*

as contemplated by the authors. In a "Kone" I have found that the velocity near the periphery at 2,000 cycles is about one-fifth that of sound in air, and in a steel disc 18.75 cm. dia. 0.058 cm. at 1,600 cycles it is about half the velocity of sound in air. The velocity increases from the centre outwards and also with the frequency.

If the velocity were infinite, i.e., disc and coil quite rigid, it is easy to infer from a recent paper by the writer (see *Phil. Mag.* supplement, June, 1929) that the combination would be quite useless as a loud speaker, since the energy falls away rapidly beyond 1,000 cycles. This is due to "interference," as explained in *The Wireless World*, March 23rd, July 6th, September 21st, 1927.

It is by virtue of resonances that the moving-coil speaker reproduces the upper register at all. Resonances in the Balsa wood speaker are more pronounced than those in a paper cone, owing, doubtless, to the greater rigidity and lesser damping of the wood.

N. W. McLACHLAN.

London.

EMPIRE BROADCASTING.

Sir,—I venture to suggest that the leading article in your issue of February 26th shows a want of consideration for foreign listeners. Here, in Siam, we exiles appreciate the 2LO programme, relayed on short-wave by 5SW, far more than any other, and we cannot but resent any proposal to cut down the programme to two hours. Try to imagine the thrill of hearing Big Ben striking midnight when one is having breakfast several thousand miles away!

Bangkok, Siam.

RICHARD OGLE.

[Our suggestion had for its object providing a 24-hour service at reasonable cost, and was put forward only as a provisional arrangement pending sufficient funds for a full transmission. —Ed.]

PRINTING THE PROGRAMMES.

Sir,—Criticism of the B.B.C. programmes is freely given, and is, in many cases, somewhat futile, but I should like to add a contribution to these futilities by expressing what I believe to be the views of an average listener.

(1) Now that those in the neighbourhood of London are able freely to tune in the National, London, or Midland programmes, I would suggest to the B.B.C. that these three programmes should be printed in parallel columns in their official organ, so that listeners may see at a glance which items they wish to hear.

(2) Discussions are becoming unconvincing, and usually degenerate into a "chipping" match between the two or three exponents, and would be improved by an impartial summing-up by an independent chairman.

(3) We have far too much imported Americanism, both in music and dialogue (this may be personal prejudice); surely there must be plenty of British talent able and willing to take the place of the American comedian with his curious vernacular or exotic sentimentality, and plenty of good British music to substitute for "hiccapped" jazz. I use this word to define a debased and artificial form of syncopation, of which the legitimate and artistic use is one of the oldest of musical artifices, dating back to the time when musicians first confined ancient plain-song melodies within measured bars, and is essential in academic counterpoint. Syncopation in the form so often presented to us in modern American jazz is forced and unnatural and, especially in songs, gives the impression that the performer is attacked with violent hiccups, hence I suggest that it would better be known as "hiccipation."

WILLIAM HEATH.

Teddington.

READERS
?
PROBLEMS

ANSWERED

The Service is subject to the rules of the Department, which are printed below; these must be strictly enforced in the interest of readers themselves.

A selection of queries of general interest is dealt with below, in some cases at greater length than would be possible in a letter.

"The Wireless World" Supplies a Free Service of Technical Information.

Short-wave Adaptor.

Would it be possible to use the Super-heterodyne Short-wave Adaptor, described in your issue of April 23rd, in conjunction with a Det.-2 L.F. set with capacity-controlled reaction? If so, will you please explain how the unit should be connected to the receiver?

D. H.

As stated in the article describing the piece of apparatus to which you refer, it is essential that the set with which it is used should have at least one stage of high-frequency amplification. Consequently, your receiver, as it stands, cannot be used unless you go to the length of adding to it the necessary high-frequency amplifier.

o o o o

Receiving the National Programme.

The aerial-grid circuit of my original "Everyman Four" receiver does not seem to be capable of being tuned down to 261 metres. How can it be altered to do so?

R. P. B.

Before making any alterations you should assure yourself that the aerial is joined to the terminal which connects to the tapping point on the primary coil; with this form of connection a smaller proportion of the aerial capacity will be transferred to the secondary than when the coupling between open and closed cir-

cuits is at its maximum, and so the tuning range will be extended slightly.

If the lower limit of tuning is still too high it will be necessary to take off three or four turns from the secondary winding. Again, however, it would be as well to make sure that there is no unnecessary stray capacity across the H.F. valve grid circuit.

o o o o

A Lightweight Portable.

I am proposing to build a small attaché-case portable similar to the set described in your issue of April 18th, 1928. As long-wave reception will not be required, the conventional capacity-controlled system of reaction will be used, with a feed-back winding coupled to the frame aerial. Do you think that this will yield as good results as the throttle-controlled circuit of the original receiver?

M. F. A.

This circuit arrangement should be quite satisfactory, provided that you maintain a reasonably high capacity between plate and filament of the detector valve. We would refer you to a paragraph dealing with this subject in last week's issue.

o o o o

Alternative Filter Circuits.

I am told that it is necessary to shunt the mutual condenser of a capacity-coupled filter with a high resistance, in order that the grid of the valve to which it is connected shall not be isolated. Will you please tell me if this is correct? I have seen no mention of the need for doing so in the articles on the subject that have been published in your journal.

J. A.

This depends on the actual position in the circuit of the condenser which serves to couple the two circuits of the filter. If matters are so arranged that the rotors of the tuning condensers are exactly at earth potential, as shown in Fig. 1, diagram (a), then it will be clear that there is no conductive path between the grid of the valve and its filament, and in consequence it would be necessary for the coupling condenser (C_m) to be shunted by a leak. Otherwise the grid might become choked by the accumulation of a charge on the condenser; furthermore, the bias cell shown would be ineffective.

If the conventional arrangement

[Fig. 1(b)] discussed in the articles to which you refer is adopted, no leak is necessary. Electrically, these two forms of connection are similar, but in the second circuit the rotors of the tuning condensers are above earth potential to a very slight extent as far as oscillatory currents are concerned.

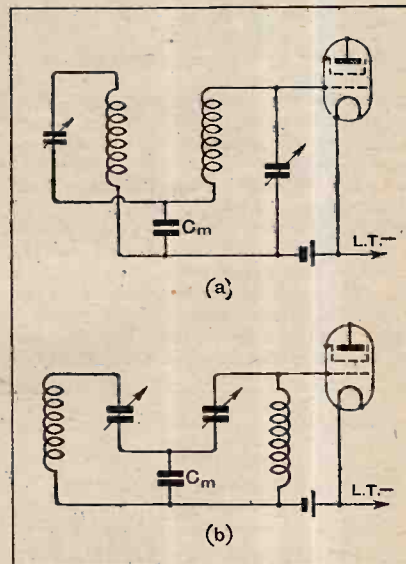

Fig. 1.—Alternative positions for the coupling condenser in filter circuit. Diagram (a) shows a method that requires the addition of a leak across C_m , or of a condenser-leak combination in the valve grid circuit.

o o o o

Reducing Power Transformer Voltage.

To avoid the necessity for buying a new power transformer I wish to feed the filament of a 4-volt rectifying valve from one of the centre-tapped secondary windings of an existing component which is rated at 7.5 volts. To retain symmetrical conditions, it seems to me that it will be essential to divide the necessary series resistance into two parts. Is this correct?

P. R.

Yes; symmetrical conditions will be retained if you divide the voltage-reducing resistance into two equal parts, and connect one of them in each of the filament supply leads.

- RULES.**
- (1.) A query must be accompanied by a COUPON removed from the advertisement pages of the CURRENT ISSUE.
 - (2.) Only one question (which must deal with a single specific point) can be answered. Letters must be concisely worded and headed "Information Department."
 - (3.) Queries must be written on one side of the paper and diagrams drawn on a separate sheet. A self-addressed stamped envelope must be enclosed for postal reply.
 - (4.) Designs or circuit diagrams for complete receivers or eliminators cannot ordinarily be given; under present-day conditions justice cannot be done to questions of this kind in the course of a letter.
 - (5.) Practical wiring plans cannot be supplied or considered.
 - (6.) Designs for components such as L.F. chokes, power transformers, complex coil assemblies, etc., cannot be supplied.
 - (7.) Queries arising from the construction or operation of receivers must be confined to constructional sets described in "The Wireless World"; to standard manufactured receivers; or to "Kit" sets that have been reviewed.

The "Everyman Four" on Long Waves.

Will you please refer me to the back number in which long-wave plug-in coils for the original "Everyman Four" were described? N. R. B.

This receiver was designed solely for the medium broadcast band, and specific instruction for winding long-wave coils has not been published.

We may point out that the "Standard Four" described in our issues of November 30th and December 7th, 1927, may be considered as being a two-range version of the "Everyman Four." Specifications for long-wave coils were given in these articles, and a suitable type of interchangeable coil mounting was described.

o o o o

"Electrification by Instalments."

Referring to the paragraph headed "Electrification by Instalments," in the "Hints and Tips" section of your issue for April 9th, will you please tell me if there is any reason why one of the windings of a multi-output commercial power transformer should not be used (as a temporary measure) for heating the output valve filament? The particular transformer I am thinking of buying has a high-tension winding, a rectifier filament winding, and also a secondary output of 4 volts at 4 amps., which is intended by its makers for supplying the heaters of A.C. valves.

My proposal is to use this last-mentioned winding, which, by the way, is centre-tapped, for supplying the filament of my output valve, which requires 2 volts.

Will you please suggest the best method of procedure? E. F. B.

This is quite a good plan. We presume that at some later date you propose to re-

winding of the power transformer, the requisite voltage for the output valve filament should be obtained. Of course, this is the winding that will afterwards be used for supplying all the heaters.

It is just possible that under the very light load imposed by the normal type of directly heated output valve—as compared with the loads for which the transformer is designed—voltage regulation will hardly be good enough, unless special precautions are taken, with the consequence that your existing valve may be slightly overrun. We suggest, therefore, that the necessary potentiometer across the filament should be made to act as an artificial load by choosing a component with an unusually low value. A 2-ohm heavy-duty rheostat, of the type sold for filament-control purposes, could easily be adapted for this purpose by making a connection to the end of the resistance winding that is normally "free."

o o o o

Quality Changes with Wavelength.

In an attempt to eliminate all possible sources of distortion, I have recently overhauled the detector-L.F. portion of my receiver: the alterations seem to have been successful, and I am now turning my attention to the H.F. side. I am wondering whether the fitting of filter circuits would be worth while, and, in order to make a decision, have been critically studying the reproduction of various stations on the medium waveband. I have come to the conclusion that attenuation of the upper register is very much more marked towards the upper end of the tuning scale. Is this in accordance with theoretical considerations?

M. S. C.

Yes. No doubt the inductance of your

FOREIGN BROADCAST GUIDE.

PRAGUE

(Czecho-Slovakia).

Geographical position: 14° 26' E., 50° 5' N.
Approximate air line from London: 635 miles.

Wavelength: 487 m. Frequency: 617 kc.
Power: 5 kW.

Time*: Central European (one hour in advance of G.M.T.).

* B.S.T. coincides with C.E.T.

Standard Daily Transmissions.

07.00 B.S.T. relay of concert from Carlsbad (Sunday); 11.15 gramophone records; 12.00 time signal and news; 12.35 concert; 15.55 news (German and Czech); 20.00 main programme; 22.00 news, time signal. Usually closes down at about 23.00 with the words *Dobrou-noch* (phonetic).

Male and female announcers. Call: *Allo Praha* or, if with relays, *Allo Praha, Br(u)no, Bratislava, Kosice, Moravska-Ostrava*.

Details of items in programmes when broadcast for International relay are also given in the German and French languages.

Relays: Bratislava-Feriby (279 m., 1,076 kc., 1.25 kW.); Brno (Brunn) (342 m., 878 kc., 2.4 kW.); Kosice (293 m., 1,022 kc., 2 kW.); Moravska-Ostrava (263 m., 1,139 kc., 10 kW.).

the ratio of capacity to inductance is increased.

It would be difficult to discuss this matter adequately in a letter, and we think our best course is to refer you to articles in our issues of April 24th and May 1st, 1929, in which the advantages, from the point of view of high-note retention, of using a large inductance in conjunction with a small capacity were discussed.

o o o o

A Remote Pick-up.

Will you please give me a word or two of advice as to the best method of procedure in my own particular case? The receiver is installed in an upstairs room, but I wish to use a gramophone pick-up in the lower floor room in which the loud speaker is mounted. I am aware that it is undesirable to use long leads between pick-up and set, and should like to know if there is any way out of the difficulty.

P. H. F.

It is true that instability and sometimes induction troubles are encountered when the pick-up is operated at a considerable distance from the receiver. You might use a transformer between the two, and earth one side of the primary winding. It is also a good plan in these cases to use a pick-up with windings of specially low impedance, such as that made by Graham Amplion, Ltd.

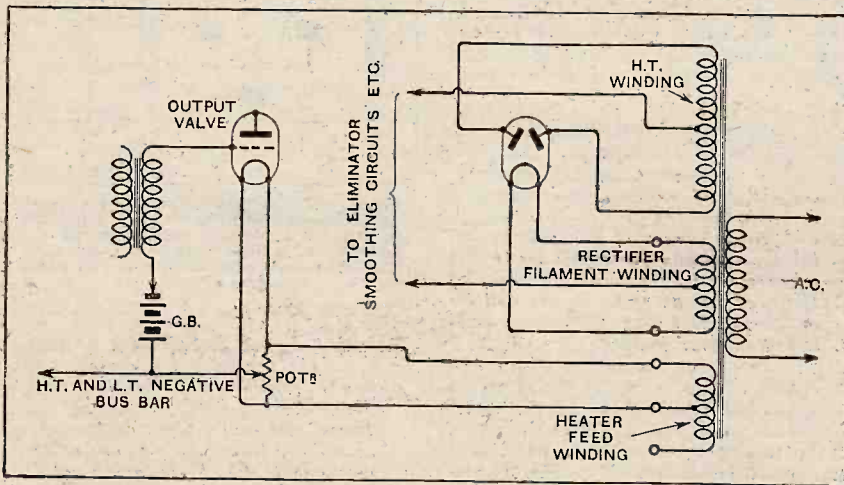

Fig. 2.—How to use a 4-volt transformer output, intended for heating A.C. valves, for supplying the filament of a 2-volt battery valve.

place your present valves throughout by those of the indirectly heated type. In the meanwhile we suggest that the best course to adopt is that indicated in Fig. 2; by taking the connection between one end and the centre point of the heater feed

tuning circuits remains constant over the medium waveband, but its capacity will be progressively increased from the lower to the upper ends of the scale. It can be shown that the loss of sidebands which adversely affects quality is increased as

A 6 MONTHS GUARANTEE



**SEALED AND
SIGNED WITH
A FAMOUS NAME**

FRANKLIN-FRANKLIN-FRANKLIN

a name that stands for something new in paper dielectric fixed condensers—for honest values and a full six months' guarantee of absolute reliability. When you buy a FRANKLIN Condenser you buy an exact capacity and one which has been tested under heavier strains than you are ever likely to use.

MANUFACTURERS: You must test these out before purchasing for your new season's productions! Enquire for samples and keen quotations, and allow us to quote for any special items to your own specification.

We will stand by our condensers for **6 full working months**, so sure are we of their **undoubted superiority**.

PRICES:

TESTED AT:— Working voltage.	500 D.C. 240 D.C. or 160 A.C.	500 A.C. 240 A.C.
.001 to .1 mfd.	1/8	1/9
.25 mfd.	1/8	2/-
.5 mfd.	1/10	2/8
1 mfd.	2/-	2/6
2 mfd.	2/8	3/8
3 mfd.	4/-	4/9
4 mfd.	4/8	5/10

Also made in larger and smaller capacities and for use at higher pressures.



FRANKLIN CONDENSERS

FRANKLIN ELECTRIC CO. 187-189, Ilford Lane, ILFORD.
Telephone: ILFORD 0281.

D·C to A·C



If your supply mains are D.C. you can operate an A.C. All-Electric Receiver by using the



**D. C. to A. C.
ROTARY
TRANSFORMER**

Can be supplied to run from any voltage 12-250 V.D.C. 40 watt model £13; 85 watt model £19. Recommended and used by Philips Radio, Marconiphone, Burndep, Kolster-Brandes, M.P.A., Etc., Etc.

Write for Pamphlet 596/1 which gives full details.

**THE M-L MAGNETO SYND. LTD.,
Radio Dept., COVENTRY.**

Telephone: 5001.



MISCELLANEOUS ADVERTISEMENTS.

NOTICES.

THE CHARGE FOR ADVERTISEMENTS in these columns is:

12 words or less, 2/- and 2d. for every additional word.

Each paragraph is charged separately and name and address must be counted.

SERIES DISCOUNTS are allowed to Trade Advertisers as follows on orders for consecutive insertions, provided a contract is placed in advance, and in the absence of fresh instructions the entire "copy" is repeated from the previous issue: 13 consecutive insertions 5%; 26 consecutive, 10%; 52 consecutive, 15%.

ADVERTISEMENTS for these columns are accepted up to FIRST POST on THURSDAY MORNING (previous to date of issue) at the Head Offices of "The Wireless World," Dorset House, Tudor Street, London, E.C.4, or on WEDNESDAY MORNING at the Branch Offices, 19, Hertford Street, Coventry; Guildhall Buildings, Navigation Street, Birmingham; 260, Deansgate, Manchester; 101, St. Vincent Street, Glasgow, G.2.

Advertisements that arrive too late for a particular issue will automatically be inserted in the following issue unless accompanied by instructions to the contrary. All advertisements in this section must be strictly prepaid.

The proprietors retain the right to refuse or withdraw advertisements at their discretion.

Postal Orders and Cheques sent in payment for advertisements should be made payable to **ILLIFFE & SONS Ltd.**, and crossed **& Co.** Notes being untraceable if lost in transit should not be sent as remittances.

All letters relating to advertisements should quote the number which is printed at the end of each advertisement, and the date of the issue in which it appeared.

The proprietors are not responsible for clerical or printers' errors, although every care is taken to avoid mistakes.

NUMBERED ADDRESSES.

For the convenience of private advertisers, letters may be addressed to numbers at "The Wireless World" Office. When this is desired, the sum of 6d. to defray the cost of registration and to cover postage on replies must be added to the advertisement charge, which must include the words Box 000, c/o "The Wireless World." Only the number will appear in the advertisement. All replies should be addressed No. 000, c/o "The Wireless World," Dorset House, Tudor Street, London, E.C.4. Readers who reply to Box No. advertisements are warned against sending remittance through the post except in registered envelopes; in all such cases the use of the Deposit System is recommended, and the envelope should be clearly marked "Deposit Department."

DEPOSIT SYSTEM.

Readers who hesitate to send money to unknown persons may deal in perfect safety by availing themselves of our Deposit System. If the money be deposited with "The Wireless World," both parties are advised of its receipt.

The time allowed for decision is three days, counting from receipt of goods, after which period, if buyer decides not to retain goods, they must be returned to sender. If a sale is effected, buyer instructs us to remit amount to seller, but if not, seller instructs us to return amount to depositor. Carriage is paid by the buyer, but in the event of no sale, and subject to there being no different arrangement between buyer and seller, each pays carriage one way. The seller takes the risk of loss or damage in transit, for which we take no responsibility. For all transactions up to £10, a deposit fee of 7/- is charged; on transactions over £10 and under £50, the fee is 2/6; over £50, 5/-. All deposit matters are dealt with at Dorset House, Tudor Street, London, E.C.4, and cheques and money orders should be made payable to Illiffe & Sons Limited.

SPECIAL NOTE.—Readers who reply to advertisements and receive no answer to their enquiries are requested to regard the silence as an indication that the goods advertised have already been disposed of. Advertisers often receive so many enquiries that it is quite impossible to reply to each one by post.

"WIRELESS WORLD" INFORMATION COUPON

This Coupon must accompany any Question sent in before

MAY 21st, 1930

For Particulars of Free Service, see Rules on page 521.

Mention of "The Wireless World," when writing to advertisers, will ensure prompt attention.



ALL WIRELESS WORLD COILS, DIALS & CABINETS
Short Wave Coils, etc.

B&J Wireless Co.
2, 3, & 4, Athelstane Mews, Stroud Green Rd., N.4.
Archway 1695.

□□□ and now—see
□□□ televisions are practical—
you can see for yourself—build one yourself—own one yourself.
they can be used with an ordinary receiver without extreme voltages.

see—at
appleby's
CHAPEL STREET, MARYLEBONE, LONDON, N.W.1.
Telephone: Paddington 8828 (3 lines).

Kits 16 gns. Instruments 25 gns.
Delivery from stock.
Qualified advice on installation.
Part exchanges arranged if desired.
Particulars on application.



WANDER PLUGS
Actual size, nickel plated, 6 colours. 2DW
Standard size, 2DW or Midget, 2d. each.
Write for List X100.

J. J. EASTICK & SONS,
118 Bunhill Row, London, E.C.1

BONA FIDE TRADERS' GUIDE.

Send for our comprehensive Illustrated List.
QUICK SERVICE. QUICK SERVICE.

THE QUALITY HOUSE.
PERSEUS MFG. CO., LTD. (Dept. W.W.),
BRANSTONE RD., BURTON-ON-TRENT.

SPECIFIED
for the
"POWER PENTODE TWO"

Polar "Volcon" 0001 5/6.
Polar "Ideal" 0005 12/6.

WINGROVE & ROGERS Ltd.
188-9, Strand, London, W.C.2.



Aluminium Cabinets and Screening Boxes.

All sizes to order.
Standard screening boxes 6" x 6" x 6" 5/- each, including baseboards.

YATES SUTTON LTD., Sheet Metal Workers,
York Street, Leicester.

RECEIVERS FOR SALE.

SCOTT SESSIONS and Co., Great Britain's Radio Doctors.—Read advertisement under Miscellaneous. [0264]

HIRE a McMichael Portable Set, by day or week, from Alexander Black, Wireless Doctor and Consultant, 55, Elbury St., S.W.1. Sloane 1655. [0328]

BURNDEN 5-valve Ethogrand, with valves and coils, £7/10; Marconi V2, 30/-; ditto, with amplifier, 50/-; carriage extra.—James Scott and Co., Radio Engineers, Dunfermline. [0333]

B.T.H. 3-stage Receiver, Mazda (A.B., P.C.), power, as new; £4.—Blood, Church St., Eye, Suffolk. [9403]

A KILO Mag Four, just built, "W.W." cabinet, latest Mazda valves; £15.—Edwards, 17, Florence Rd., Hanford, Stoke-on-Trent. [9395]

MARCONIPHONE Straight Eight Receiver, complete with Marconiphone A.C. eliminator, 6v. accumulator, also Marconiphone short wave adaptor, 15-150 metres, and Brown A.C. moving coil loud-speaker, all as new; what offers?—H. L. Milne, Milnshaw, Ansell, Lytbam St. Annes. [0394]

NEW Halcyon Portable, leather suitcase £20 model, S.G.4 Celestion speaker; £13, or offer.—"Dorian," 45, Melbourne Av., Slough, Bucks. [9392]

GRANIC Neutrosone Short Wave 6-valve Receiver, as new, all coils and valves, oak cabinet; cost £28, accept £18.—Clements, 11, Manton Av., W.7. [9380]

FOR Sale, B.H.C. 5-valve long range receiver, as new, loose coupled tuned aerial coil, 2 H.F. screened grid valves, with tuned H.F. transformers, covers complete band 200-2,000 meters, with change over device. Super Selective set, perfect reproduction, cost £45, complete with valves; Marconiphone wave trap, covering long and short waveband, cost £4; 3 60-volt C.A.V. H.T. accumulators; the lot £30, or near offer; seen working by appointment any morning before 12; North London.—Box 5910, c/o The Wireless World. [9359]

GETTING Down To It!

A GOOD Portable for £9/19/6, complete with 5 standard English valves and English batteries, weighing 22lb., in a strong case of pleasing and simple design. Lizard grained finish, one-dial tuning, of performance and tone surpassing many portables of three times the price. No rash claims are made—produced by Appleby's, and is real value for money.

FOR Some Time Past there Has Been a Want for a Simple Straight Portable—for the individual who requires it as a portable—when he is in motion, but—the price must be reasonably low, for its use does not justify a heavy outlay to the person, whatever the depth of his pocket, mainly using a permanent receiver.

THEREFORE Appleby's have deviated from Their Usual Programme of Money's No Object and Got Down to It.

WHY Not Invest in One! A portable banishes dull moments, it's a companion you can switch off, and it does not cost a lot to take around.

GET One—it's worth it. It's produced by Appleby's, and, in its class, is worthy of a treasured name.

IF You Live Away from London, and cannot inspect before purchase, buy one anyway, because, well, it's Appleby's, and the portable won't leave if it's wrong.

THE Portable was Introduced on Monday, May 5th. Up to the time of going to press, May 7th, we have sold seven, two to notabilities everyone knows. It is gratifying that five letters of appreciation have already been received.

£9/19/6 complete from Appleby's, Chapel St., Marylebone, London, N.W.1. Phone: Paddington 8828 (3 lines). [9462]

50-WATT Power Amplifier, 3-stage, LS6As in output; cost £25, sell £5; brand new; bargain.—Priestley, 74, Abercrom Rd., Highbury, London, N.5. [9452]

A.C. All Mains 3-valve B.T.H. Ediswan Latest Model; bargain, £15/10 complete.—75, Southam Rd., Hall Green, Birmingham. [9448]

RADIO-GRAM., complete, and as new; cheap, £10.—27, Primula St., W.12. [9435]

BERCLIF D.C.2 All Mains Receiver. 200 to 250 volts D.C.; price £14/10; with valves and royalties, suitable for M.C. speaker; particulars free; trade inquiries specially invited.—Simmonds Bros., Shireland Rd., Smethwick. [8734]

YOUR Old Receiver or Components Taken in Part Exchange for New; write to us before purchasing elsewhere, and obtain expert advice from wireless engineer of 25 years' professional wireless experience; send a list of components or the components themselves, and we will quote you by return post; thousands of satisfied clients.—Scientific Development Co., 57, Guildhall St., Preston. [0226]

GOOD 5-valve Suitcase Portable, as new, £10; M.P.A. cone unit, 7/-; Mullard transformer, 12/-; J.B. 0.0003, 6/-; both as new; other goods cheap; list on request.—F. Caddick, 15, Stanley Park Rd., Wallington. [9434]

Receivers for Sale.—Contd.

"WIRELESS World" Schools Demonstration Amplifier, complete, 2 L3.6A's, 2 V65/550, 1 V8, as new; cost of components £30/14/10, price £17/10.—Elsdon, Fairview, Barming Heath, Maidstone. [9430]

LANGHAM 5-valve Portable, at half price, brand new unused 18 guinea set for 9 guineas.—Premier Supply Stores, 165, Fleet St., E.C.4. [9428]

LISSEN Portable 5, as new; £9.—Write Parsons, Shirley Institute, Didsbury, Manchester. [9420]

1930 Music Magnet, unopened, owner bought all-mains; £6/10.—59, Atherley Rd., Southampton. [9453]

BATTERIES.

EXIDE B.K. Accumulators, eight blocks of 24v. each; what offers?—Haddon, 31, Bedford St., W.C.2. [9376]

ACCUMULATOR HIRE.

DON'T Buy Accumulators or Dry Batteries, join our C.A.V. low- and high-tension accumulator hire service, the largest and best in London; better and cheaper reception with no trouble; regular deliveries within 12 miles of Charing Cross; no deposit, payment on each delivery or by quarterly subscription; over 10,000 satisfied users; explanatory folder post free; phone or write to-day.—Radio Service (London), Ltd., 105, Torriono Av., N.W.5. Phone: North 0623-4-5. [8751]

CHARGERS AND ELIMINATORS.

CHEBROS.—Chebros for all types of transformers and chokes, high grade instruments at a very moderate price; enquiries invited.—Chester Bros., 244, Dalston Lane, London, E.8. [5290]

TANTALUM and Lionium for A.C. Rectifiers; for inexpensive chargers; blue prints for H.T. and L.T., 1/- each; Lionium electrodes, 2-3 and 5-8 amps.—Blackwell's Metallurgical Works, Ltd., Garston, Liverpool. [8298]

DYNIC A.C. H.T. Eliminator, £3; Regentone, £3; Philips L.T. charger, £2/10; Ferranti trickle chargers, £1/10; carriage extra.—James Scott and Co., Radio Engineers, Dunfermline. [0335]

ZAMPA H.T. Eliminator Kit Comprising, rectifying unit (incorporating transformer, condensers, Westinghouse H.T.3), necessary condensers, choke, terminals, baseboard, etc., output 120 volts at 20 m.a., complete; 45/-; 7 days' approval against cash; other Zampa kits and transformers on request.—Mic Wireless Co., Market St., Wellingborough. [9300]

PHILIPSON'S Safety High Tension Supply Units for A.C. and D.C. Mains, 200-250 volts 40-60 cycles, also 230 volts 25 cycles.

10/- Down and Small Monthly Payments Secures the Finest H.T. Supply Available.

PHILIPSON'S Safety H.T. Units are Guaranteed for 12 Months Against All Defects.

ALL Models Sold on 7 Days' Approval to Ensure Complete Satisfaction.

PHILIPSON'S Safety H.T. Units are the Cheapest to Install and the Cheapest to Run; £1/17/6 to £6.

WRITE for Our Booklet "Radio Power," which gives illustrations and full particulars.

PHILIPSON'S Safety Loud Speaker Output Filters for All Receivers, power valve, or Pentode; a remarkable output filter at a very low price; 16/6.

PHILIPSON and Co., Ltd., Radio Engineers, Astley Bridge, Bolton. Phone: 2038 Bolton. [0318]

SAVAGE'S Specialise in Wireless Power from the Mains, reliable apparatus at reasonable prices.

SAVAGE'S.—Transformer laminations and Bakelite bobbins; intending home constructors should write for list.

SAVAGE'S.—Reliable smoothing condensers, 1,500 volt D.C. test, 1 mfd., 2/-; 2 mfd., 3/-; 4 mfd., 5/3; 500 volt D.C. test, 1 mfd., 1/6; 2 mfd., 2/3; 4 mfd., 3/9.

SAVAGE'S.—Super smoothing and output chokes, many types available; write for list.

SAVAGE'S.—Mains transformer for Westinghouse H.T.4 unit, with additional winding, 4 volts centre tapped 3 amps, 23/-; transformers for other Westinghouse units available.

SAVAGE'S.—Mains equipment for new Foreign Listeners Four, transformer N.F.L.4, 33/-; smoothing choke, C32G, 20/-; output choke C32O, 20/-.

SAVAGE'S Mains Equipment for Power Pentode Two output choke, LC36PG, 19/6; smoothing choke, LC36G, 18/-.

SAVAGE'S.—Mains transformer B.T.4, 500-0-500 volts, 120 m. amps., 7½ volts 3 amps., 6 volts 3 amps., 4 volts 2 amps., 4 volts 1 amp., 4 volts 1 amp., all centre tapped, specially developed for automatic bias; 57/6.

SAVAGE'S.—Mains transformers and power chokes are carefully and individually constructed from first class materials, with an exceptionally generous margin of safety.

SAVAGE'S, 146, Bishopsgate, London, E.C.2. Phone: Bishopsgate 6998. [9165]

A Remarkable Drum Dial

This J.B. Precision Instrument is the most up-to-date on the market to-day. It makes tuning easier and more accurate, and its action is so smooth that it is a real pleasure to handle.

PRICE 10/6



All parts of the Dial are insulated from the Condenser, so that the drum becomes an anti-capacity shield and may be earthed.

The scale is Ivorine, reading 0-100, and is reversible so that reading may be altered to 100-0.

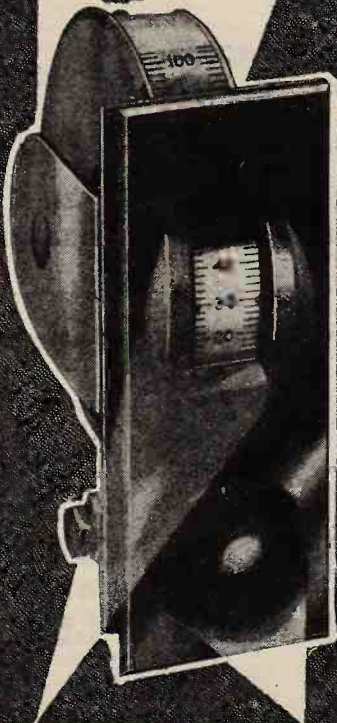

The scale is flush with the panel, making it exceptionally easy to read. The powerful friction drive prevents backlash and slp.

By a patented method the Control Knob is placed immediately below the scale—the most convenient place for it.

Advertisement of Jackson Brothers, 72, St. Thomas' St., London, S.E.1. Telephone: Hop 1837.

Chargers and Eliminators.—Contd.

REGENTONE H.T. Eliminator, type W.4, 230 volt A.C. input, D.C. 200 volts, 100 m.a., 3 variable tappings, 0-180, 1 fixed, 200 volts; £8, no offers.—Baker, 133, Trafalgar St., Gillingham, Kent. [9363]

TRICKLE Charger, for H.T. and L.T. accumulators, all voltages up to 12 volts, as new; £3/10.—L. E., 57, The Avenue, Beckenham. Beckenham 1106. [9374]

FERRANTI B.E.M.1 Eliminator, 200v. 100m.a., as new, list £13/10, £9; Ferranti trickle charger, 35/-; valves two P625, two P625A's, 9/- each.—Bury, 8, Shear Brow, Blackburn. [9404]

MARCONIPHONE All-Power Mains Transformer, type C (boxed), 15/-; 30 henri choke, 7/-; 20 henri, 6/-.—Frost (see Pick-ups). [9441]

50 Atlas High Tension Chargers, output 400v. 100 m.a., incorporating £7/10 Westinghouse rectifier, universal input, use as accumulator charger, H.T. eliminator, or for feeding M.C. speaker pot; to clear, £4/10 each.—Daniels, 54, City Rd., E.C.2. [9450]

PHILIPS L.T. Charger, No. 450 (200 volt A.C.), 2-6 volts x 1.3 amps., as new; 40/-; approval.—Faulkner, 175, Station St., Burton-on-Trent. [9446]

REGENTONE W.2A, input 200-250 volts A.C., 50 cycles, output 160 volts 50 m.a., and 4 volts 4 amps. A.C., L.T.; £4/15.—White, "Fairview," South Eden Park Rd., Beckenham. [9440]

HEAYBERD-WESTINGHOUSE 2 amp. Metal Charger; 40/-; perfect.—Wormald, 28, Victoria Rd., Halifax. [9432]

FELLOPHONE A.C. Unit, 200-250, output 100; offer.—J. Harmer, Hollington, Hastings. [9429]

WESTINGHOUSE Rectifiers, A.4, 9v. 2 amps., as new; 29/-.—13, Ealdham Sq., Eltham, London. [9417]

MULLARD H.T. Eliminator, 105 volt mains, new condition; £2/15.—B. V., 10, Parsial Rd., Hampstead, N.W.6. [9415]

SURPLUS Bargains by Post.—A.C. mains transformers, guaranteed, voltage doubling 12/6, reducing 11/6; state supply voltage; H.T. only; no filament winding, panel switches, 4-pole change over, suitable wave change, 2/-; post free, approval, cash with order.—Oliver, 325, Kennington Rd., London, S.E. [9413]

CABINETS.

DIGBY'S Cabinets.—Table models in solid oak and mahogany; from 11/6 to 71/-.

DIGBY'S Cabinets, fitted with Radion or Resistou ebonite if required.

DIGBY'S Cabinets.—Pedestal model, with separate battery components; from 56/- to £12.

DIGBY'S Cabinets Made to Customers' Own Designs.

DIGBY'S Cabinets.—Write for new 16-page art catalogue.—F. Digby, 9, The Oval, Hackney Rd., E.2. Phone: Bishopsgate 6458. [0328]

KAY'S Cabinets, the greatest range of pedestal cabinets in the kingdom; original creative designs at prices 50% lower than elsewhere; quotations for specials by return; delivery at short notice guaranteed.

RADIOGRAM Cabinets.—A variety of really practical and exclusive models from 60/-; illustrated lists free.

H. KAY, Wireless Cabinet Manufacturer, Mount Pleasant Rd., London, N.17. Phone: Walthamstow 1626. [8963]

A LIMITED Number of Magnificent Radio-gramophone Cabinets, brand new, panel size 18in. x 7in., oak £6, mahogany £7; larger size, with double doors, panel 21in. x 8in., oak £11, mahogany £12/10; portable cabinets (suitcase type), 30/-; transportable (oak or mahogany), £2; cabinets with oval panel opening, suit 2- or 3-valve set, 17/6; carriage extra.—James Scott and Co., Radio Engineers, Dunfermline. [0334]

WIRELESS Boxes, 40, new, solid oak, polished; sacrifice, 3/- each; frets, 1/-.—Bell, 119, Arlington Rd., Camden Town. [9396]

COILS, TRANSFORMERS, ETC.

TRANSFORMERS and Chokes for Battery Eliminators.—Chester Bros., 244, Dalston Lane, London, E.8. [8652]

LEWCOS Q.S.P. and Q.A.A., as new; what offers? —Darwent, 2, Morville Rd., Chorlton-cum-Hardy. [9368]

1,000 ohms Decoupling Resistances, specified for Power Pentode Two; 1/6 each.—Groves Brothers.

600 ohms Decoupling Resistances, specified for new Kilo Mag Four; 1/6 each, post free.—Groves Brothers.

120 and 1,000 ohms Resistances for new Foreign Listeners Four; 1/6 each, post free.—Groves Brothers.

NEW Kilo-Mag Four Coils, 37/6 set; slotted coil formers, for winding, Kilo-Mag Four 12/6 set, 1930 Everyman Four 8/6 set; Kitset 10/6 set; Ideal home receiver 9/- set, all post free.—Groves Brothers, St. Mary's Place, Shrewsbury. [9361]

Coils, Transformers, Etc.—Contd.

- BAND-PASS Filter H.F. Transformers and Aerial Units**, for flat top tuning and no cutting of sidebands, dual wave; 18/6 each.—Groves Brothers, St. Mary's Place, Shrewsbury. [9362]
- NICOLE I**, perfect; 14/6.—Beel, 25, Lilymead Av., Knowle, Bristol. [9387]
- BERCLIF Coils**, the standard of excellence for all "Wireless World" receivers; latest lists post free; trade supplied, all quantities.—Simmonds Bros., Shireland Rd., Smethwick. [8735]
- VARSITY Short Wave Choke**, 2/6; Get America every night, writes Ultra-Short (Dorset).
- POWER Pentode Two**, parts as specified; alternative components also supplied.—Frost (see Pick-ups). [9442]
- L.F. Transformers**, by Marconiphone Co., 5: 1, excellent for portables; 3/- each; few only.—BM/ZZEZ, London. [9421]
- SET of Four Coils for 1929 Melody Maker**; what offers?—W. B. 114, Hambalt Rd., Clapham, London, S.W.4 [9410]

DYNAMOS, ETC.

BANKRUPT Stock—Three B.T.H. Panatrop motor generators, input 200-250v. D.C., output 720v. D.C., 140m.a.; three ditto, input 100-125v. D.C., same output, working order, in metal cases; £12/10, carriage paid.—Franks, 42a, St. George's St., London, E.1. Phone: Royal 8546. [9412]

GRAMOPHONES, PICK-UPS, ETC.

- PICK-UPS**, Super Phonovox, 29/6; Woodroffe, 39/6; various coils, cheap.—BM/ZM3N, London, W.C.2. [9388]
- VARSITY Sweetone Pick-up**; see "W.W." page 362; compare curves and price; 10/6! Set adapter, 2/-.—Frost, 54, Clerkenwell Rd., E.C.1. [9443]
- B.T.H. Pick-up and Tone Arm**; 27/6.—Chapman, 17, Whitley Rd., Tottenham. [9433]
- LISSEN Needle Armature**, with tone arm, 25/-; Varley, with Watmel arm, 25/-.—Write BM/BS3R, W.C.1. [9436]

TRANSMITTERS.

- CHEBROS**. Chebros. Chebros transformers and chokes of all descriptions, special transformers for transmitting and modulation; chokes a speciality; enquiries invited.—Chester Bros., 244, Dalston Lane, London, E.8. [5240]
- MACKEY Generator for Sale**, 1,500 volts, 150 watts, field excitation 6 volts; £3/10; would accept good portable set in exchange, or other good components; Piezo crystal wavemeter.—Wynn, Balsall Common, Coventry. [9366]
- QUARTZ Lenses**; 2/-; guaranteed oscillate without reaction.—Smith, Bryn Rodyn, Colwyn Bay. [9402]

LOUD-SPEAKERS.

- BAKER'S SELHURST RADIO 36-page Booklet**, "Sound Advice is Yours for the Asking"; write now for new edition; see displayed advertisement on page 14. [0231]
- VIBRO-SKIN Special Leather for Fixing the Diaphragm of the Moving Coil Loud Speaker**; price 2/- per piece 1 1/2 in. square, 1/6 per piece 9 in. square; post free; cash with order.—The Alder Leather Co., 3, Southwark St., S.E.1. Tel.: Hop 4448. [0330]
- R.K. Moving Coil**, £3; 2 old M.C. speakers, £1 each; new moving coil speakers, 220v. A.C., £3; carriage extra.—James Scott and Co., Radio Engineers, Dumfriesline. [0336]
- PERARDUA Moving Coil Reproducers**—These superlative instruments may be obtained for 15/- down, balance by 5 equal monthly payments; cash prices, 230-volt D.C., £3/3; 6-volt, £3.—R. Vevers, 4, York Rd., Maidenhead. [9169]
- BARGAIN**—Brown's Mascot, good as new; £2.—Withers, "Sandycroft," Romley, Ches. [9401]
- MAGNAVOX Moving Coil R-7**, for mains, complete with output transformer; £3; perfect order.—Hunter, 49, Queenswood Court, King's Av., S.W.4. Brixton 1737. [9398]
- CELESTION C.12** (mahogany), as new; £4.—146, Cranford Lane, Heston, Hounslow. [9365]
- BROWN Duplex V.15**, mahogany; cost £12/10; perfect; £7/10.—59, Atherley Rd., Southampton. [9456]
- CELESTION C.10**, oak, nearly new, perfect; £2.—Box 5994, c/o The Wireless World. [9439]
- BARGAIN**—Super Cinema Epoch moving coil loud-speaker, as new and perfect; £7/10; carriage extra.—W. Fair, 158, Kingston Rd., Staines. [9426]

VOX-VERITAS
3 CORNERED BAFFLE

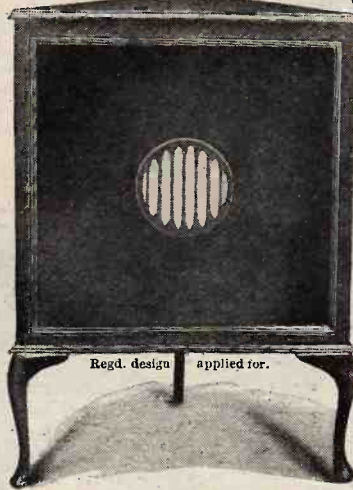

Board Dimensions 30" x 30". 3/4" ply. Centre Opening 8", other sizes to order. "The Wireless World," Dec. 18th, says: "A handsomely finished baffle." This hand-polished baffle board is built with open sides and bottom which entirely eliminate box resonance. Removable top and rear leg folds flat against front.

Oak Finish, Jacobean - 38/6
Mahogany Finish, Queen Anne - 42/-
Carriage forward.

MOVING COIL SPEAKERS
50/-

6 volt, 8 amp. or D.C. Mains any voltage.
Send for descriptive leaflet.
VOX-VERITAS
Morogoro Trading Corporation Ltd.,
12, Union Court, Old Broad Street, London, E.C.3.
Phone: London Wail 8236.

BELLING-LEE
THE WORLD'S GREATEST
WANDER PLUG
NOW
ONLY 3D
BELLING-LEE
FOR EVERY RADIO CONNECTION

Ad. of Belling & Lee, Ltd., Queensway Works, Ponders End, Md.

Loud-Speakers.—Contd.

- EPOCH Moving Coil Speakers** are Masterpieces, designed and produced by master engineers.
- EPOCH Moving Coil Speakers** are the Standard by which other Speakers are Compared.
- EPOCH Moving Coil Speakers** are in Use in Many Editorial Offices.
- EPOCH Moving Coil Speakers** are in Use in Several Famous Laboratories.
- EPOCH Moving Coil Speakers** are in Use in Many Broadcasting Stations.
- EPOCH Moving Coil Speakers** are in Use by Most Prominent Musicians.
- EPOCH Moving Coil Speakers Bring Unbounded Joy** to Thousands upon Thousands of Homes.
- EPOCH Moving Coil Speakers**, the only speakers that give clear, uncoloured reproduction.
- EPOCH Moving Coil Speakers do Render Speech** Perfectly and Music Correctly.
- EPOCH Moving Coil Speakers Provide the Perfect Illusion** of the Artist's Presence.
- EPOCH Moving Coil Speakers Represent the Finest Intrinsic Value Ever Offered.**
- EPOCH Moving Coil Speakers are Guaranteed for a Year**, but last for ever.
- EPOCH Moving Coil Speakers Bring the Grand Concert** out of the Most Modest Set.
- EPOCH**—You can hear a hundred moving coil speakers, but Epoch is different.
- EPOCH**—If you own the best set, only by Epoch can you confirm it.
- EPOCH**—Away with the tin can and cracked banjo reproduction, and install an Epoch.
- EPOCH**—Away with the drumminess, droniness and huskiness of the average moving coil speakers.
- EPOCH**—The clearest, sharpest, cleanest reproduction—a marvel of accuracy and beauty.
- EPOCH Moving Coil Speaker Models** from £2/10 to £30.
- EPOCH Moving Coil Speakers**—Models for every requirement and taste.
- EPOCH Permanent Magnet Moving Coil Speakers**—Nine models from £3/15.
- EPOCH Permanent Magnet Moving Coil Speakers** Require no Mains or Batteries.
- EPOCH Permanent Magnet Speakers** are more Sensitive than most Energised Moving Coil Speakers.
- EPOCH Energised Models** are the Finest ever put on the Market.
- EPOCH Super Cinema Speaker** has Created the Biggest Sensation for Many Years.
- EPOCH Super Cinema Model** is many times as Sensitive as the so-called Supers.
- EPOCH Super Cinema Speakers** give Enormous Volume from a 1-watt Amplifier.
- EPOCH Super Cinema Speakers** are used on many 100-watt Amplifiers and never "rattle."
- EPOCH Super Cinema Model** is Standard on several Talkie Equipments.
- EPOCH Super Cinema Model** is already in use in over 200 Cinemas.
- EPOCH Super Cinema** are the only Moving Coil Speakers used in Large Theatres, unaided.
- EPOCH Super Cinema Speakers** provide alone the Upper as well as the Lower Register.
- EPOCH**—Other Moving Coil Speakers require the help of exponential horns to provide depth.
- EPOCH**—A list of many prominent cinemas using the Speakers supplied on request.
- EPOCH Speakers** are not Made of Tin or Aluminium Stampings, but are sound, solid, engineering jobs.
- EPOCH Heartily Invite Comparison**, on all counts, with any make, regardless of price or claims.
- EPOCH**—Don't accept our quality claims without verification, but don't accept any other maker's either.
- EPOCH**—Order one of 7 days' approval, and test with a switch-over; the only real test.
- EPOCH Moving Coil Speakers** may be heard in our Demonstration Room Daily.
- EPOCH**—Our demonstration room is in the heart of London.
- EPOCH**—Its accessibility has been studied for the convenience of callers.
- EPOCH**—If you cannot call, write for booklet W.S.3, and approval terms.
- EPOCH RADIO MANUFACTURING Co., Ltd.**, Farringdon Av. (near Ludgate and Holborn Circuses). Phone: Central 1971. [8983]

Mention of "The Wireless World," when writing to advertisers, will ensure prompt attention.

VALVES.

VALVES—P.M.24, 15/-; P.B.4DX, 7/6; P.M.14, 14/-; 84V, 4-pin, 15/-; 154V, 5-pin, 8/6; guarant. teed.—Box 5970, c/o *The Wireless World*. [9379]

AMPLIFIER Valve—If you require power you cannot do better than one of these:—

FILAMENT Volts 6, plate volts 400 (maximum), grid bias 84 volts (approx.), impedance 800 ohms, amplification factor 3.8, mutual conductance 4.35 m.a./volts; price £5/10; see article "The Wireless World," 24th July, 1929, then send to North London Valve Co., Ltd., 22½, Cazenove Rd., Stoke Newington, London, N.16. [9407]

OSRAM M.S.4, M.H.4, M.H.L.4, M.L.4, P.X.4, new, unused; 2/3 list.—59, Atherley Rd., Southampton. [9457]

EXPERIMENTER'S Surplus Valves, only slightly used, perfect.—Two Osram P625, 7/6 each; two Osram L.S.5A, 10/6 each; two Mullard 84V, 12/6 each; one Mullard 24A, 12/6; one Osram M.H.L.4, one M.L.4, 10/- each; one Marconi S.G., old type, slips, 5/-; postage extra.—W. Fair, 158, Kingston Rd., Staines. [9427]

WIRE.

WIRE—Every size and kind from Beaver Engineering Co., 4, Upper Grosvenor Rd., Handsworth, Birmingham. [9384]

WIRE Wound Resistances to Specification; technical data given; frame aerial, Litz, and fuse wires; send your enquiry!

ENAMELLED D.S.C., D.C.C. and resistance; ounces supplied.—Frost, 54, Clerkenwell Rd., E.C.1. [9444]

COMPONENTS, ETC., FOR SALE.

BELLING-LEE Panel Fittings are designed to give an expert finish to any home-constructed set; catalogue post free.—Belling and Lee, Ltd., Queensway Works, Ponders End, Middlesex. [0018]

WESTON Model 301, milliameters, ammeters, and voltmeters, 21/- each; hot wire ammeters 0-1 amps., 4/-; 0-0.5 amp., 3/-; instrument repairs and alterations; send for list.—The Volta Electrical Co., 47, High St., Battersea, S.W.11. Established 1910. [8626]

COMPONENTS Lent on Hire.—Details from Alexander Black, Wireless Doctor, 55, Ebury St., S.W.1. Sloane 1655. [0329]

IDEAL for Experimenters.—Dismantled components, condensers, valve holders, L.F. transformers, rheostats, etc.; 5/- per parcel; send to-day; carriage paid.—Hart Radio Supplies, East High St., Falkirk. [9260]

ELECTONE Automatic Time Switch Enables You to set your radio programme in advance, and ensures getting all the items you want, 24 hour clock; price 21/-.—Fredk. J. Gordon and Co., Ltd., 92, Charlotte St., W.1. [9283]

FOREIGN Listener's Four set Broadcast coils, 12/6; valves, new, 2 84V, 12/6 each; 1-16, 4V, 7/6.—Makinson, 279, Poulton Rd., Wallasey. [9386]

MOTOR Generator, G.E.C., direct coupled, 32v. 17.5 amp. D.C. input, 500w. at ¼ kilowatt output, strong heavy machine, cost £20, scarcely used, £7/10, or offer; 2 Brown's type F, 7/6 each; 2 Brown's type A, 2,000-4,000v., 17/6 each; Telefunken, 4,000v., 3/-.—Hill Crest, Hill Crescent, Whetstone, N.20. [9393]

ALL New!—Lotus differential condenser, 0.00015, 4/6; 2 Lissen R.C. units, 4/6; Triton R.C., 2 volt, 2/6; L.S.5A, 9/6 (slightly used).—Thornton, Guy's Hospital. [9405]

ALL New Goods.—R.K. Senior, D.C., 7 guineas, accept £4 (must be collected if sold out of London); B.T.H. 20-1 transformer, 15/-, accept 8/-; 120 m.a. D.C. H.T. eliminator, £7, accept £2/10 (seals unbroken); 2 Mazda S215, 13/- each; 2 P650, 12/- each; 1 P.M.6D, 6/-; B.T.H. pick-up and tone arm, 25/-; B.T.H. volume control, cost 14/6, take 6/-.—Newth, 8, Leicester Place, London, W.C.2. (facing The Empire, Leicester Sq.). [9406]

CONDENSERS, voltmeters, resistances, valves, other components; cheap; stamp for list.—32, Berkeley Rd., Newbury. [9399]

MICROPHONE, Marconi, heavy type; to be sold or changed; offers to A. A. G., 47, Arbour Lane, Chelmsford. [9371]

TUNGSRAM Valves, L.F., H.F., R.C., 5/6; power, 7/3; super power, 8/-; R.C. loud-speaker units, 9/3; postage free.—G. Scott, 11, Bicester Rd., Richmond. [9422]

SUPERDYNE Unit, transforms your obsolete 2- or 3-valver into a powerful portable without extra valves.—Particulars, Ledsham, 297, King St., Hammer-smith. [9369]

SPECIAL Oak Cabinet by Arcraft, new, to take panel 16in. x 8in. and batteries, 15/-; Ferranti 3-range meter, in mahogany case, 25/-, push type.—Robins, Lingerest, Carlton-Colville, Suffolk. [9360]

YOU MAY HAVE HEARD!

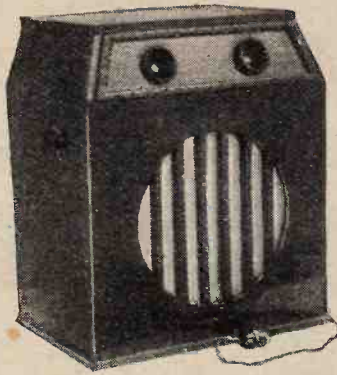

Electrojets 2.

You may have marvelled at the remarkable life-like reproduction of both speech and music. You may have touched its one dial tuning control, and seen your local Regional disappear, and your favourite foreigner take its place. You may have used an Electrojet 2 for months on end, day in day out without the slightest attention, there are no batteries or accumulators. It works entirely from your electric light supply, and costs less than a ½d. per hour. Contained in a handsome polished wood cabinet. And the price complete is

£14 : 5. A.C. Mains.
(Including Royalties.)

Specification:
Rectification. Westinghouse Metal Rectifier.
Valves. Osram.
Speaker. Blue Spot Unit and Cone.

BUT YOU HAVE NOT HEARD!

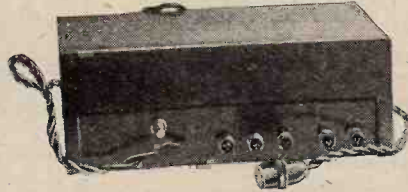

Electrojets Eliminator.

Size only 11½ x 6½ x 3½.

It is silent!
Incorporating Westinghouse Metal Rectifier, and contained in a polished wood cabinet to match your set, in either Oak, Mahogany or Walnut.

Output 120 volts 20 milliamperes.
70 volt detector tapping.
4 volt L.T. winding.

Complete as illustrated with switch, 4 yds. flex and adaptor or two pin plug.

£4. A.C. Mains.

(As above but without cabinet and switch £3 : 15).

All Electrojets products are guaranteed for 12 months, and are British made.

May we send you our Illustrated Catalogue Post Free on request.

COMING NEXT WEEK, ELECTROJETS ALL-ELECTRIC 2 VALVE TABLE MODEL RADIO GRAMOPHONE. WATCH FOR IT!

THE ELECTROJET RADIO CO.,
Rowington, Warwickshire.

Components, Etc., For Sale.—Contd.

RADIO HOUSE, HUDDERSFIELD, issues the Reliability Wireless Guide, which will be sent post free upon request by Messrs. J. H. Taylor and Co., 15, Macaulay St., Huddersfield. [7823]

PART Exchange.—See our advertisement under Receivers for Sale.—Scientific Development Co., 57, Guildhall St., Preston. [0228]

A 4 Westinghouse Rectifier, 30/-; 2 T.O.C. electrolytic condensers, 22/6; Varley power transformer, E.P.3, 18/-; Ferranti 0.7 voltmeter, 23/-; all unused.—Harvey, Laurel Villa, Gloucester Rd., Cheltenham. [9424]

R.I. Pick-up Arm, 10/6; Lotus QA coil, 8/6; Parex Titian, 7/6; Colvern R2R, 5/-; pair Tunewell Clarion, 10/6; Lewcos 200x, 4/-; McMichael IA, with base, 4/-; Lewcos HFSP, 4/6; Lewcos Ultra SW, RAS4, RAS9, AMS4, AMS9, 4/6 each; Cosmos ANP and base, 200-600, 5/6; Ormond friction, 0.0005, 8/6; No. 3, 3/-; Clydon 0.0005, 3/-; Karas 0.00025, 6/6; Niko 0.0005 reaction, 2/9; Lotus 0.0005, 3/6; Formo 0.00025, 2/9; Pye differential, 3/-; Wamel tuner, new type, 8/-; PMIA, 5/-; Climax binocular HF chokes, 4/6; Lissen, 3/-; Utility switches, DPDT, 2/3; Lotus, with terminals, 2/3; Philips 328 and 451 rectifier valves for L.T. chargers, 7/- each.—G. A. Ryall, 182, Kennington Rd., London. [9423]

H Gramophone Records, 17/6; H.T.3 rectifier, 15/9; P.M.24, 15/-; Cleartron S.G.215, 7/6; all as new.—G. Williams, 7, Chapel St., Portmadoc. [9418]

B.T.H. Universal Electric Gramophone Motor, new, £4; Collaro clockwork ditto, new, 35/-; B.T.H. pick-up and arm, latest type, as new, 30/-; R.I. Varley heavy duty push-pull input transformer, unused, 12/6.—68, Leander Rd., Thornton Heath. [9391]

VOLTMETER, switchboard type, 0-10v., 5in. dial, 5/-; ditto, 0-150v., 4in. dial, 10/-; ditto, 0-1,000v. Metro-Vickers, with shunt 6½in. dial, 50/-; all D.C.—Hill Crest, Hill Crescent, Whetstone, N.20. [9411]

A S New, Woodroffe pick-up, 35/-; B.T.H. pick-up and arm, 25/-; new type Lissen needle armature pick-up and arm, 25/-; Philip transformer, 10/-; Climax special L.F. choke, 6/-; 2 wavemeter logarithmic condensers, 0.0005, 5/- each.—Bevins, 4, Loanda St., Haigerston, E.8. [9408]

1,000 ohms Decoupling Resistances, specified for Power Pentode Two; see advert. under Coils.—Groves Brothers. [9461]

TABLE Volume Control, 8/-; new M.H.L. 4-valve, 9/-; new unused Exide W.Y. accumulators, 50 volts, 28/-; H.M.V. and Parlophone constant frequency records.—Temple, Knockdolian, Comrie. [9455]

115 A.C. 2 amp. Battery Charger, G.E.C., 25/-; new Langham cone speaker, 25/-; 1.E.5 valve, 6/6; Langham £18 portable, new, £8.—16, Berther Rd., Hornchurch, Essex. [9454]

WIRELESS Transmitting Sets for Morse Telegraphy or Distant Control of Models, etc., 1in. spark coil, condensers, spark gap, helix, etc., very compact, complete and ready to use, 12/6; high quality buzzer, good note, 3/6; heavy Morse tapping key with points, 3/6.—Below.

ELECTRIC Motors, ¼ to ½h.p., 110 to 220 volts D.C., silent running, carbon brushes, in perfect condition and working order, suitable for gramophones, television, or any small power uses, 10/-; a few with overheated windings, if rewound make good dynamos for H.T. accumulators, 6/-.—Below.

COMPLETE Portable Telephone, magneto ringing, ready for use, 17/6; hand telephones, 4/6; 1,000 ohm H.F. chokes, 1/-; large earphones, 1/3; G.P.O. magnetic relays, high class instruments, 12/6; telegraphic relays, 6/6.—Below.

HIGHLY Sensitive Button Microphones, mounted in case with two terminals, all new 2/-; watch type microphones, 2/6; breast plate microphones, with condenser and key switch, 7/6; microphone smoothing condensers, 6d.; microphone transformers, 2/6; 1in. spark coils, fully complete, 6/-; Ford ignition coils, ¼in. spark, 4/-; 2in. spark coils, 17/6.—Below.

D.C. Electric Motors, all ball bearing and carbon brushes, ¼ to ½h.p., 110 volts, 30/-; ditto, 220 volts, 50/-; 6- and 12-volt car starter motors, 10/-; ¼h.p. Crompton motors, 220 volts, ring oil bearings, shunt wound, as new, 65/-; 110v. motor blower, ¼h.p. motor, 4in. outlets, 45/-; ditto, enclosed, 2in. outlet, 40/-.—Below.

DYNAMOS shunt wound for charging or lighting, 50 volts 4 amps., 35/-; 100v. 3a., 45/-; 110v. 3 amp., ball bearing, 55/-; 20v. 8 amp., ball bearing, 30/-.—Below.

NEW Shunt Regulators or Field Rheostats, to carry 10 amps., 20/- each; other starters and regulators suitable for field rheostats or accumulator charging resistances, 2 amps., 7/6; 5 amps., 10/-; 8 amps., 12/6.—Below.

ALL Above Goods Guaranteed; cash with order or c.o.d.; all goods 3 days' approval from date of delivery; all letters answered.—Galpin, Hinfield Heath, near Henley-on-Thames. [9449]

"MAGIC" POLE FINDER

The Instrument of many uses.

Will instantly detect the presence of an electric current in any circuit from 1 to 250 Volts.—

Negative pole inside Pole Finder shows purple colour on Direct current.— Both poles show purple colour on Alternating current.— Colour disappears again on disconnecting. Can be used thousands of times.



5/- post free



FREDK. ADOLPH, Actual Maker, Phone: 27, Fitzroy Street, London, W.1. Museum 8329.

LET A "SUPREMUS" H.T. ELIMINATOR DRIVE YOUR SET

B15 MODEL



PRICE 21/-

D.C. The B15 Model, giving 60 and 120 volts, 15 M/A. Price 21/-, as illustrated.

A.C. The E10 Model, giving 60 and 120 volts, 10 M/A. Price 65/-, complete with valve.

D.C. The C25 Model, with tappings of 60, 120 and 150, 25 M/A. Price 32/6.

A.C. The E15, with tappings of 60, S.G and 120, 15 M/A. Price 70/- complete

All models guaranteed 12 months. 24 models in stock.

Write for lists.

Valve or Westinghouse Rectification optional.

SUPREMUS SPECIALITIES LTD.,
118, HIGH STREET, ERDINGTON, B'HAM.

Northern Agents: THE CHORLTON METAL CO., 18, Amber Street, Manchester.
London Agent: P. H. SMEDLEY, 50, Richmond Road, Leytonstone, E.11.

Components, Etc., for Sale.—Contd.

P.M.24A, 17/6; A.C./P1, 12/6; 2 L.S.5As, 12/6 each; Varley pick-up, 25/-; all unused; W.E. cone, cost £6/6, £2/17/6, as new.—Holroyd, Leighton, Oven-den Wood, Halifax. [9453]

M.L. Converter, B.X., 6 to 120 volts, one variable, 40 to 85v., £4; Marconi B2 2-stage amplifier, L.S.5 valves, £3/10; valves, L.S.5, 6/-; D.E.5, 4/-; D.E.8 H.P., 3/6.—"Whincroft," Market Av., Chichester. [9451]

ATLAS A.O.16 Eliminator, £2/10; Pye 32H choke, 8/-; Pentamu output, 10/-; T.C.C. 4 mfd., 3/9; all perfect.—Briggs, Carlton Rd., Shipley. [9447]

MATEUR'S Surplus.—Philips mains, 3v., 230v., 50, nearly new, £16; Ferranti O.P.M.1 (e) push-pull, 18/-; Brown £4/4 pick-up, 20/-; G.E.C. Victor Three, nearly new, £4/10; Geophone 2-stage amplifier, £2/10; 2 Brown microphone amplifiers, 1 L.R., 1 H.R., 30/- each, perfect and not government surplus.—Box 5995 c/o The Wireless World. [9445]

SALE.—Ferranti A.F.5C, O.P.M.1C, centralab volume control, Ostram D.E.5, used twice; accept £3, nearest.—Box 5993, c/o The Wireless World. [9438]

COSSOR Pentode 2v. and Mullard, 12/6 each; Pentamu transformer, 12/-, all as new; Mullard P.V. H.F. six-sixty H.F. Cosmos L.F., 5/- each; 2v.—I. Hawkins, 11, Station Lane, Wombwell, near Barnsley. [9437]

FERRANTI A.F.3, 14/6; A.F.5, 20/-; A.F.4C, 12/6; O.P.3C, output, 14/6; Philips £3/17/6 D.C. eliminator, 45/6; 2 P.M.254, 8/6 each, as new, perfect; c.o.d.—4, Brecon Rd., Handsworth, Birmingham. [9431]

EXPERIMENTER'S Components, all as new, perfect; Ferranti A.F.6 transformer, 15/-; Ferranti O.P.M.2C transformer, 12/6; Philips L.F. transformer, 10/-; E.L.P. Pentamu, 10/-; 2 Pye logarithmic 0.0005 condensers, slow motion, 6/- each; complete set original Foreign Listeners Four coils, £1; Lewcos H.A.C. and B.A.R. binocular coils, 5s and 20s, 10/-; 4 T.C.C. 0.1 condensers, 9d. each; one dual reading voltmeter, 3/6; postage extra.—W. Fair, 158, Kingston Rd., Staines. [9425]

MISCELLANEOUS.

ALEXANDER BLACK,

THE Original Wireless Doctor, will call (London and Home Counties) and cure your set.

CONSULTATIONS by Appointment Without Obligation, sets installed, maintained, and brought up to date, gramophone pick-ups, eliminators, and Webson moving coil speakers demonstrated; purity reproduction specialists.

55, Ebury St., Victoria, S.W.1. Sloane 1655. [0277]

CALIBRATE Your Set With the C.D.E.S. Calibration Chart; 8d., post free.—C.D.E.S., 98, Cherry Orchard Rd., Croydon. [8612]

SCOTT SESSIONS and Co., Great Britain's Radio doctors, officially approved as wireless repairers by Radio Society of Great Britain and Wireless League; old sets of every type repaired, rebuilt, modernised; send set for immediate quotation.

SCOTT SESSIONS and Co.—New sets constructed with your or our components, guaranteed finest workmanship; we specialise in "The Wireless World" circuits; remember, we have satisfied customers throughout the British Isles and in three Continents; if you so desire, we will design and construct high grade apparatus to suit your special circumstances for quality, range and selectivity.—Tel.: Tudor 5326. Muswell Hill, London, N.10. [0262]

EASY Payments.—We supply, by easy payments, components, accessories, and sets, any make; 10% down, balance spread over 11 months.—Send list of requirements to London Radio Supply Co., 11, Oak Lane, London, E.C.2. [0337]

ENGINEERS.—Novice or expert; £300, £400, £500 per year or more is within your grasp. In our handbook "Engineering Opportunities," Prof. A. M. Low explains where the good posts abound. This handbook has shown the way to better things to over 20,000 of your fellows. It contains details of A.M.I.Mech.E., A.M.I.E.E., A.M.I.C.E., A.M.I.A.E., A.M.I.Struct.E., Matric. C. and G. P.O., etc., Exams., outlines home study courses in all branches of electrical, mechanical, motor and wireless engineering, and shows the unique advantages of our appointments department. Why stay in the Hammer and Pile Brigade? Send for our free handbook at once, stating branch, post or exam. which interests you.—British Institute of Engineering Technology, 87, Shakespeare House, 29-31, Oxford St., London, W.1. [9280]

MOTOR, 200-220 volts, D.C., ¼ h.p. mounted with charging dynamo, £3, would separate; electric fan, 200 volts, D.C. £1/2/6; iron, 200 volts, 8/6; Drummond 4in. lathe, foot motor, well equipped, £16.—E. W. Herbert, 18, Upper Phillimore Place, London, W.8. [9397]

THOR Juvenator, 230 volt, complete, as new; cost £10/10, sell £8.—G. Alderson, Dorridge, Birmingham. [9459]

METAL Cabinets



Precisely to specification and sealed with Tabular brass gauze, for ALL "WIRELESS WORLD" SETS
Oak Base and Oak Finish - - - 57/6 complete
Mahogany - - - - - 63/-
Oak Base and imitation Leather - - - 63/-
Metal Container and Copper Screens, less woodwork 47/6
COILS, DRUM DIALS AND ESCUTCHEONS to "W.W." Specification.
1930 Everymag Four 47/8 per set
NEW Kilomag IV - 45/-
Record III - 45/-
Wave Trap - 10/3
53 Drum Dials with Escutcheons 5/8 each.
RIGBY & WOLFENDEN,
Sheet Metal Workers
Milnrow Road, ROCHDALE. Phone 2948



CLIX All-in Plug & Socket

All up-to-date receivers incorporate this Clix device which entirely supersedes the old type panel terminal. Entirely insulated whether connected or disconnected. Perfect contact always.

Prov. Pat.

Write for the Clix Folder containing illustrations and full details of the CLIX in VARIETIES

ALL-IN PLUG & SOCKET

PRICE Complete 8d.

LECTRO LINX, LTD., 254, Vauxhall Bridge Road, LONDON, S.W.1.

POWER CHOKES

substantially built, for smoothing circuits in eliminators dealing with currents from 100 to 300 milliamperes, inductance 30 henries, 8/6 post free.

REPAIRS

to any make of L.F. Transformer, Loudspeaker or Headphones. All repairs dispatched within 48 HOURS—TWELVE MONTHS' GUARANTEE with each repair. 4/- Post Free. Terms to Trade

TRANSFORMER REPAIR Co.

Dept. W., 514, High Street, Colliers Wood, London, S.W.19.

Patent Plug Connectors for Electric Irons.

BAKELITE ADAPTORS with moulded-in contacts, suitable for Eliminators, All Mains Sets, Radio Gramophones, etc.
TURNOCK'S MOULDINGS,
41, High Street, Aston, BIRMINGHAM.

600 OHMS DECOUPLING RESISTANCES

SPECIFIED FOR "NEW KILOMAG" FOUR and "Foreign Listeners Four"
1/6 EACH POST FREE. Manufactured by GROVES BROTHERS, ST. MARY'S PLACE, SHREWSBURY. 1,000 ohms 1/6 each.

Mention of "The Wireless World," when writing to advertisers, will ensure prompt attention.

PATENT AGENTS.

PATENTS and Trade Marks, British and foreign.—Gee and Co. (H. T. P. Gee, Member R.S.G.B. and A.M.I.E.E.), 51-52, Chancery Lane, London, W.C.2. Phone: Holborn 1525. [0001]

KING'S PATENT AGENCY, Ltd., 146a, Queen Victoria St., E.C.4.—Free advice and handbook on patenting inventions and registering trade marks by registered agent with 43 years' experience. [0002]

AGENCIES.

AGENTS Wanted in Most A.C. Districts to Demonstrate and Sell Electrosets as Advertised; good commission; 14 days' trial.—The Electroset Radio Co., Rowington, Warwickshire. [9409]

REPAIRS.

SCOTT SESSIONS and Co., Great Britain's radio doctors; read advertisement under Miscellaneous column. [0263]

REPAIRS Returned Post Free, and to ensure satisfaction send remittance after approval of same.—Leeds Wireless Repair Service.

LOUD-SPEAKERS, headphones, rewound to any resistance and remagnetised, 3/-; transformers rewound, 4/-; Blue Spots, Triotrons and 4-pole units, 4/6; work guaranteed.—Leeds Wireless Repair Service, 5, Boston Place, Green Rd., Leeds. [9329]

GUARANTEED Repairs by Experts.—Loud-speakers, headphones, cone units, pick-ups, any type, rewound, remagnetised, and adjusted, post free 4/-; transformers, from 4/-.—Howell, 91, Morley Hill, Enfield, Middlesex. [7882]

WANTED.

BROWN or Similar 9-valve Amplifier, a number of Brown P.Q. or Power speakers.—Particulars and price to Baker, 133, Tatalgar St., Gillingham, Kent. [9364]

MILLIAMETERS, 0-500, A.F.6 transformers, heterodyne wavemeter and Piezo crystal control for amateur band, in exchange for L.S.5a and L.S.6a, P.M.24, P.M.2DX valves, hardly used; half price; other components; card for list.—Wynn, Balsall Common, Coventry. [9367]

ALL Types of Electrical and Wireless Apparatus Purchased for Cash; large quantities only.—T. W. Thompson and Co., 17, Strutton Ground, S.W.1. [0331]

ONE of Eael Type of Pye and Ferranti L.F. Chokes, burnt out; cheap.—J. Gilson, 25, Botsford Rd., S.W.20. [9372]

ROTARY Converter Wanted, input 230 volts D.C., output 230 volts 50 cycles A.C., about 400 watts; also A.C. voltmeter 0-500 volts.—Macnamara's, 19, Charlotte St., Birmingham. [9370]

WANTED, parts for Igranic, Neutrosonic short wave set or intermediate frequency amplifier alone.—Gourelay, c/o Chief Engineer, Murree, India. [9375]

WANTED, used wireless components, modern gear only; exchange for new, or will pay cash.—Radio, 8, Woodman St., Stockport. [9419]

REGENTONE High Tension Unit.—Box 5996, c/o *The Wireless World*. [9416]

WANTED, surplus wireless goods (modern), new or second-hand; cash or part exchange; branded goods only.—Particulars to Kay, 6, Forest Av., Peverell, Plymouth. [9414]

EXCHANGE.

COMPONENTS Taken in Part Payment, brand new supplied guaranteed; any reasonable suggestion accepted; cash payment not always essential; state lowest price acceptable for your goods, and particulars of new required.—Ryall's Radio, 182, Kennington Rd., London. [9264]

WE Will Accept Your Surplus Apparatus (making you a high allowance) in part payment for any new apparatus; your enquiry will be dealt with promptly.—Bostock and Stonnill, 1, Westbourne Terrace, S.E.23. [9400]

SITUATIONS VACANT.

A MATEUR Constructors Wanted as Agents in A.C. Districts for Eliminator Kits, etc.—Details from Fel-Ectric Radio, 56, Garden St., Sheffield. [9258]

INSTRUMENTS and Wireless.—Wanted, assistant, with some experience in electrical instruments and wireless apparatus, capable of making estimates and quotations, and of putting working instructions into shop.—Write age, experience, and salary expected, to "Instruments," c/o Dixons, 195, Oxford St., London, W.1. [9389]

WIRELESS Operating; fees payable after appointment; amateur Morse classes.—Manager, Wireless School, 21, Manor Gardens, London, N.7. [9378]

FORMO-DENSORS

Pre-set compression type.

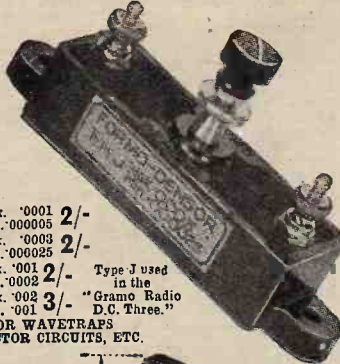

F. Max. '0001 2/-
Min. '00005
J. Max. '0003 2/-
Min. '00025
G. Max. '001 2/-
Min. '0002
H. Max. '002 3/-
Min. '001 3/-

FOR WAVETRAP REJECTOR CIRCUITS, ETC.

1930 LOG-LINE
Caps. '0005
'00035
'00025
'00015
4/6

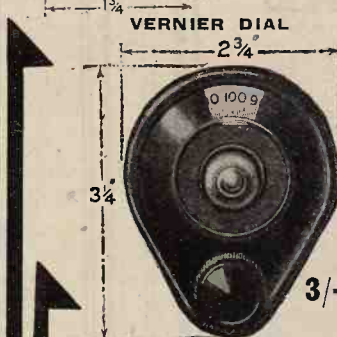
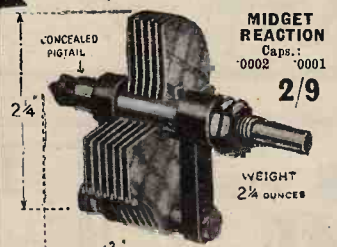
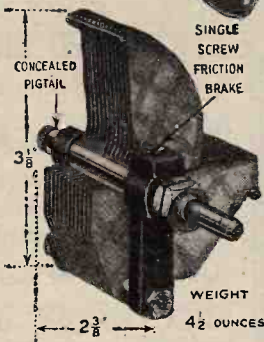

Positive Drive. No Backlash.
FORMO-DENSOR EXCLUSIVE FEATURES.
Concealed Metallic Continuity.
Self-Oiling Shafts. Lowest Di-Electric Loss, Silky Action.

POINTED EXCELLENCE



GOLDEN SQUARE, PICCADILLY CIRCUS, LONDON, W.1. Gerrard 1863.

Situations Vacant.—Contd.

YOUNG Lady Cashier Required for Wholesale Counter, must be experienced in discounts and invoices.—Write, stating age and salary required, to Box 5935, c/o *The Wireless World*. [9375]

WIRELESS Services.—The premier telegraph college in the British Isles (established 34 years) gives a sound training to all students, with assured positions on qualification; fees are not disguised under expensive board-residence scheme but are payable by easy instalments, if desired.—Apply for Prospectus, Dept. "W.W.," The London Telegraph Training College, Ltd., Morse House, Earl's Court, S.W.5. [9268]

SITUATIONS WANTED.

YOUNG Man, with secondary school education, requires employment with wireless firm, some experience.—Coombes, 4, Bristol Rd., Highbridge, Somerset. [9385]

ENGINEER, accustomed to design of talking picture apparatus, disc and film, or their maintenance, desires position.—Box 5973, c/o *The Wireless World*. [9383]

RADIO Engineer (25) desires change to reliable post, 7 years' commercial experience receiver and radio-gramophone design, research work and testing.—Box 5972, c/o *The Wireless World*. [9382]

YOUNG Man, age 19, new P.M.G. certificate, sound knowledge of technical and practical radio engineering, seeks post.—Box 5971, c/o *The Wireless World*. [9381]

BOOKS, INSTRUCTION, ETC.

FREE: Inventor's Guide on Patents.—T. A. A., 253, (W), Gray's Inn Rd., London, W.C.1 [6373]

TELEVISION—The complete authorised book on television (Baird Experimental) transmission and receiving, is now ready; order "Television To-day and To-morrow" (Moseley and Barton Chapple), 7/6 net.—Pitman's, Parker St., Kingsway, W.C.2. [9309]

STEP by Step Wireless.—A complete course of instruction for wireless engineers; send 1/- for first 4 weeks.—Clifford Pressland, A.M.I.E.E., Hampton-on-Thames. [0195]

THE INVINCIBLE

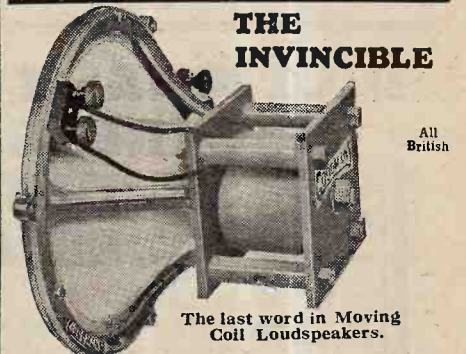

The last word in Moving Coil Loudspeakers.

Low consumption, high sensitivity—the outcome of years of research. Can be used with 2-Valve Loudspeaker set. Write for full details and send us particulars of your set. We will give you candid expert advice.

GOODMANS
27 FARRINGDON ST. LONDON. E.C.4
Telephone: City 4472.

TUNING COILS and METHODS of TUNING

By W. James. (1925)

Price 2/6 net. By post 2/10.

From ILIFFE & SONS LTD., Dorset House, Tudor Street, London, E.C.4, and leading booksellers.

w.w.32

INDEX TO ADVERTISEMENTS.

Abbey Radio	PAGE 5	General Electric Co., Ltd.	PAGE 1	Radiogramophone Development Co.	PAGE
Adolph, Fredk.	12	Gilbert, J. C.	14	Rigby & Woolfenden	12
Appleby, E. Hetherington	8	Goodmans	13	Rothermel Corporation, Ltd. (Centrallab)	5
B. & J. Wireless Co.	8	Groves Bros.	12	Standard Telephones & Electric Co., Ltd.	Cover iii.
Baird Television Development Co., Ltd.	14	Heayberd, F. C., & Co.	Cover iii.	Supremus Specialities, Ltd.	12
Baker's "Selhurst" Radio	16	Holzman, L.	2	Telegraph Condenser Co., Ltd.	3
Bayliss, William, Ltd.	11	Igranic Electric Co., Ltd.	9	Telsen Electric Co., Ltd.	Cover i.
Belling & Lee, Ltd.	10	Jackson Bros.	12	Transformer Repair Co.	12
Brownie Wireless Co. (G.B.), Ltd.	5	Lectro Linx, Ltd.	4	Tungram Electric Works	12
Bullphone, Ltd.	5	Lever, Eric J. (Trix), Ltd.	4	Turnock Mouldings	12
Burne-Jones & Co., Ltd. (Magnum)	Cover i.	Lock, W. & T., Ltd.	4	Ultra Electric, Ltd.	Cover i.
Burton, C. F. & H.	6	Loewe Radio Co., Ltd.	4	Varley (Oliver Pell Control, Ltd.)	3
Dubilier Condenser Co. (1925), Ltd.	6	London Radio Supply Co.	4	Vox Veritas	10
Eastick, J. J., & Sons	8	Lustrolux, Ltd.	4	Westinghouse Brake & Saxby Signal Co., Ltd.	Cover iii.
Edison Swan Electric Co., Ltd.	8	Lyons, Claude, Ltd.	4	Weston Electrical Instrument Co., Ltd.	4
Electroet Radio Co.	11	McMichael, L., Ltd.	4	Wilkins & Wright, Ltd.	4
Electradix Radios	14	Miscellaneous Trading Co., Ltd.	7	Wingrove & Rogers, Ltd.	8
Epoch Radio Mig. Co., Ltd.	13	M.L. Magneto Synd., Ltd.	8	Yates Sutton, Ltd.	8
Forno Co.	7	Mullard Wireless Service Co., Ltd.	Cover iv.		
Franklin Electric	7	Perseus Manf. Co., Ltd.	Cover ii.		
Gambrell Radio, Ltd.		Philips Radio			

HIGH-GRADE FIGURED OAK WIRELESS CABINET

Designed to take Set, Loud Speaker and Batteries.
 Height, 3 ft. 1 in.
 Width, 1 ft. 10 in.
£2 15 0.
 Carriage Paid.

RADIO-GRAMOPHONE CABINET
 Height, 3 ft. 7 in.
 Width, 1 ft. 10 in.
£5 5 0.
 Carriage Paid.
Illustrated Lists Free.

GILBERT, Cabinet Maker, SWINDON.
 Estimates Free.
 Established 1866.

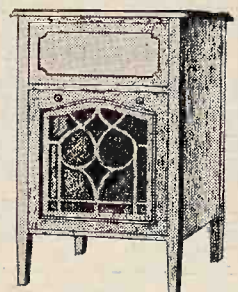

A STAMPED ENVELOPE
 will bring you our great
MAY BARGAIN LIST

Electrical Gear
 Radio Apparatus
 Measuring Instruments

Many bargains at Sacrifice prices.

ELETRADIX RADIOS
 218, Upper Thames Street, E.C.4.
 City 0191. Electradix, Cent, London.

SEND TO-DAY FOR OUR FREE 36-PAGE BOOKLET "SOUND ADVICE."



The Finest High-grade Speaker in the World

PERFECT RECEPTION FOR MUSIC LOVERS

BAKER'S "Selhurst" RADIO

Offices: 89, Selhurst Rd., S. Norwood, S.E.25.
 Works: 42, Cherry Orchard Rd., E. Croydon.

Super Power Moving Coil Speaker.

DICTIONARY of WIRELESS TECHNICAL TERMS

(1926)
 Compiled by S. O. PEARSON, B.Sc., A.M.I.E.E.
 and issued in conjunction with
 "THE WIRELESS WORLD."

This volume contains definitions of terms and expressions commonly used in wireless telephony and telegraphy and is intended to serve as a guide to all those interested in wireless who come across, from time to time, unfamiliar words in their reading. In such cases the **DICTIONARY OF WIRELESS TECHNICAL TERMS** proves of very great use and value. It is well illustrated, and cross-referenced to enable the required information to be rapidly obtained.

Price 2/- net. By Post 2/2

From leading booksellers or from the Publishers:
ILIFFE & SONS LTD.,
 Dorset House, Tudor St., London, E.C.4.

W.W.48

Mention of "The Wireless World," when writing to advertisers, will ensure prompt attention.

WIRELESS
DIRECTION FINDING and DIRECTIONAL RECEPTION

(1927)
 By R. KEEN, B.Eng. (Hons.).

Second Edition: Revised and Enlarged.

THIS volume deals with the principles of the subject and the constructional details of direction-finding installations, and includes some information concerning aircraft installation. It describes the principles of Direction and Position Finding in this country in such a way that the subject may be grasped easily by engineers tackling this field of wireless work for the first time. Numerous photographs and diagrams are included.

Price 21/- net. By post 21/9.

From leading booksellers or direct from the Publishers:
ILIFFE & SONS LIMITED,
 Dorset House, Tudor Street, London, E.C.4.

w.w 68

When buying
your A.C. Mains Receiver,
battery eliminator, or
battery charger
see that it incorporates

A

WESTINGHOUSE

METAL RECTIFIER

which is one of the most important components in up-to-date radio equipment. There is nothing to wear out in this rectifier—no filaments, no chemicals nor moving parts. It is used in the majority of modern receivers and eliminators, designed and marketed by experts who are satisfied as to its reliability, and whose aim has been to provide TROUBLE-FREE RADIO EQUIPMENT.

For those who prefer to make up their own sets, our book "The All-Metal Way, 1930" will be invaluable. It contains 32 pages of circuits and instructions covering all types of A.C. Mains Units. Send a 2d. stamp with your name and address.

The Westinghouse Brake & Saxby Signal Co. Ltd.,
 82, York Road, King's Cross, London, N.1.

PATENTS

**STANDARD TELEPHONES AND
 CABLES LIMITED**

Be glad to announce that they are the owners of more than 60 patents relating to wireless broadcast receiving sets.

These include amongst many others:—

Superheterodyne
 Push-pull
 Split Loop
 Hartley Oscillator
 Mains Receivers
 Free Grid Bias
 Gang Condensers
 Volume Control with
 Constant Impedance
 Folded Exponential Horns

and
 (in conjunction with Electrical Research Products Inc.)

Combined Gramophone
 and Radio

AND THAT they are willing to grant licences under these patents and future inventions of their own and their associated Companies to approved British manufacturers, who are invited to apply for further particulars and conditions to:—

STANDARD TELEPHONES & CABLES LTD.
 Room 717, Bush House, Aldwych, W.C.2

■ ■ A condenser cannot live to fail twice! A Hydra cannot fail to live throughout the lifetime of your set—and

longer! Hydra Condensers never fail—they do not leave our factory until we are satisfied of that!

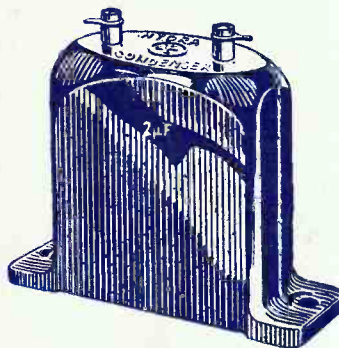

HYDRA

LOUIS HOLZMAN

37 NEWMAN STREET, LONDON, W.1.

Telephone: Museum 2641.

Unacclaimed MULLARD in the world

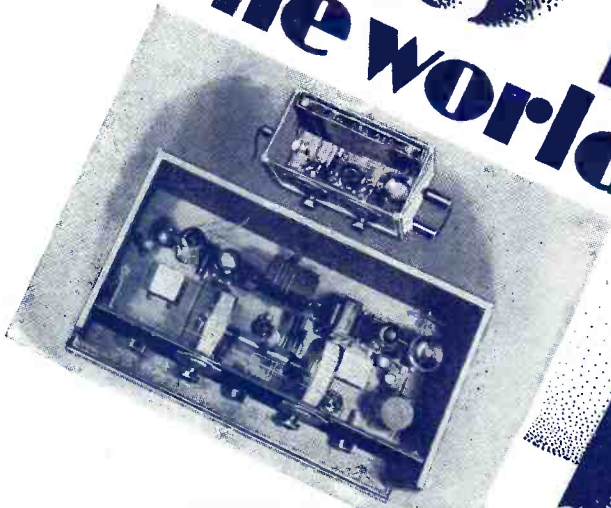

Mr. H. L. O'Heffernan (G5BY), of Croydon, Surrey, has been awarded first prize in the International contest organized by the American Radio Relay League to determine the World's best Amateur Radio Station. It is significant that Mullard Valves are used throughout the installation. You cannot go wrong by following the lead of this expert. Make it a Mullard Valve for every stage in your own receiver.

Mullard

THE MASTER VALVE

Advt. The Mullard Wireless Service Co. Ltd., Mullard House, Charing Cross Road London, W.C.2.

ARKS

Printed for the Publishers, ILIFFE & SONS LTD., Dorset House, Tudor Street, London, E.C.4, by The Cornwall Press Ltd., Paris Garden, Stamford Street, London, S.E.1

Colonial and Foreign Agents:
 UNITED STATES—The International News Co., 131, Varick Street, New York. FRANCE—W. H. Smith & Son, 248, Rue Rivoli, Paris; Hachette et Cie, Rue Réaumur, Paris.
 BELGIUM—W. H. Smith & Son, 78, Marche aux Herbes, Brussels. INDIA—A. H. Wheeler & Co., Bombay, Allahabad and Calcutta. SOUTH AFRICA—Central News Agency, Ltd.
 AUSTRALIA—Gordon & Gotch, Ltd., Melbourne (Victoria), Sydney (N.S.W.), Brisbane (Queensland), Adelaide (S.A.), Perth (W.A.), and Launceston (Tasmania).
 CANADA—The American News Co., Ltd., Toronto, Winnipeg, Vancouver, Montreal, Ottawa, St. John, Halifax, Hamilton; Gordon & Gotch, Ltd., Toronto; Imperial News Co., Toronto, Montreal, Winnipeg, Vancouver, Victoria. NEW ZEALAND—Gordon & Gotch, Ltd., Wellington, Auckland, Christchurch and Dunedin.

THE STENODE RADIOSTAT EXPLAINED.

The **Wireless** **World**
AND RADIO REVIEW

4^D

The Paper for Every Wireless Amateur

Wednesday, May 21st, 1930.



P.M.

**FIRST-
BECAUSE OF
THE FILAMENT**

Mullard
THE MASTER VALVE

Run your Portable from the Electric Supply

NO BATTERIES
NO ACCUMULATORS

EKCo

Write for Free Booklet and details of Easy Payments to F. K. Cole Ltd., Dept. W., "Ekco" Works, Leigh-on-Sea.

POWER SUPPLY UNITS FOR PORTABLES

Utility DIFFERENTIAL CONDENSER

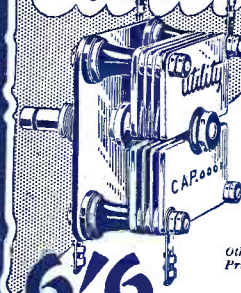

Stocked by all good dealers and the best value in a Condenser of this type that you can possibly obtain. The capacity is '0001 mfd. and the design provides smooth reaction at all points of the scale. Fully guaranteed for efficiency and finish by "Utility"—makers of the Dials, Condensers and Switches that experienced constructors always choose. Illustrated list free for a p.c.

Other Prices:

'00015	7/-
'0002	7/6
'0003	9/6

WILKINS & WRIGHT LTD.,
"Utility" Works,
Holyhead Road, BIRMINGHAM.

6/6

ACCURACY

Licensed under design Reg. No. 723271.

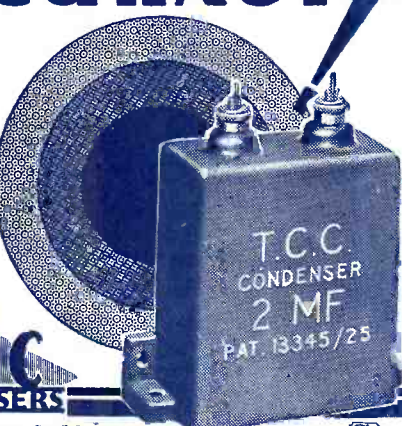

T.C.C. CONDENSER
2 MF
PAT. 13345/25

T.C.C. CONDENSERS

Advt of Telegraph Condenser Co., Ltd., Wales Farm Road, W.3. 4811



WHATEVER THE FUTURE MAY HOLD...

The present holds the finest achievement in the production of first-class Radio Receivers—the achievement of McMichael engineering. Always progressive, McMichael's present in the Super Range Portable Four a set of unique perfection.

THE McMICHAEL 1930 SUPER RANGE FOUR (TABLE MODEL)

A Screened Grid circuit fitted in handsome Walnut Cabinet and mounted on a turntable. Comprising all equipment, including self-contained frame aerial and earth. Designed for use in the home where outdoor aerial and earth are not desirable nor convenient. Range and power leaves nothing to be desired. If preferred, an outdoor aerial can be used. This gives greatly increased range and power.

Cash Price 26 GNS.

(Including all Equipment and Royalties.)



THE McMICHAEL 1930 SUPER RANGE PORTABLE FOUR

Fitted in a handsome furniture hide suitcase with patent locking clips, the set is noteworthy for its high efficiency and convenience.

The following are its notable features:

1. Screened Grid Amplification.
2. Single dial tuning and volume control.
3. High selectivity—wide range.
4. Low upkeep cost.

The 1930 model of this famous Receiver is placed still further ahead in its class whilst maintaining the original price rendered possible by ever increasing demands.

Owing to the high degree of selectivity in this, and our other Screened Grid Portable Receivers, we are able to guarantee complete selectivity between all main B.B.C. stations under the new scheme of wavelengths, as recently proved by an actual test under the twin aerials at Brookman's Park, when both programmes were received separately without interference, and in addition a number of other British and Foreign stations.

This test was made on a standard "Super Range Four" Receiver, under an independent Press observer, and was repeated at half-mile intervals with similar results.

Ask for a demonstration of this set at any high-class radio store, or call at our London Showrooms.



CASH PRICE

22 GNS. (Including all equipment and Royalties.)

Or by our special "Deferred Payments on Hire Purchase Terms" system, £5 down and 10 monthly payments of £2.1.0.

L. McMICHAEL LTD

Manufacturers of Wireless and Scientific Apparatus
WEXHAM ROAD, SLOUGH, BUCKS;
 'Phone: Slough 441-442 'Grams: Radiether, Slough
LONDON SHOWROOMS: 179, STRAND, W.C.2
 (Telephone: Holborn 2466.)

Mention of "The Wireless World," when writing to advertisers, will ensure prompt attention.

HYDRA



SERVICE WITH A BIG 'S'

Some time ago a well-known firm of wireless manufacturers was let down, and let down badly, by a condenser maker. When we came into the picture all that the latter had done was to make promises, and promises however good are not of much use when a firm is stuck for components.

The manufacturer approached us wanted to know what we could do in the way of deliveries would we help him out? We could, and did. Not by giving him "a few to go on with," not by delivering enough to keep him on half time. No, we gave him what he wanted, **in ten days we delivered 37,000 condensers into his stores.**

We flatter ourselves that no other condenser manufacturer in the world could have handled the order in such a short time. That is why we headed this page with "Service—with a big S."

We hate to draw a moral, but next time make it Hydra. Specify the best condenser, and the best service.

LOUIS HOLZMAN, 37, Newman St., W.1.

Telephone: Museum 2641.

HYDRA

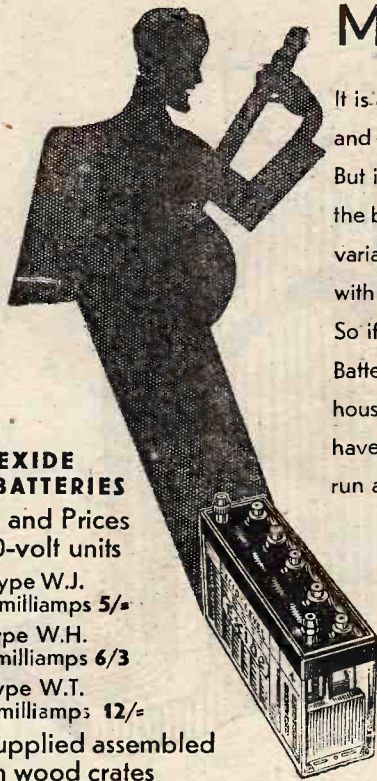

**EXIDE
H.T. BATTERIES**

Sizes and Prices
of 10-volt units

Type W.J.
2,500 milliamps 5/6

Type W.H.
5,000 milliamps 6/3

Type W.T.
10,000 milliamps 12/6

Also supplied assembled
in wood crates

MAINS OR BATTERIES?

It is a fact that you can get good results **without** batteries if you are on A.C. Mains and can afford a really good self-contained all-mains set.

But it is no less a fact that, for the most faithful reproduction, Exide Batteries remain the best source of H.T. known. Their voltage is absolutely steady, being devoid of variation or ripple. This makes them definitely superior to a separate eliminator used with an existing receiver—a very inferior arrangement to a self-contained all-mains set. So if you have a battery-operated set and your house has A.C. Mains then use Exide Batteries, keeping them automatically charged with an Exide Trickle Charger. If your house has no A.C. Mains then Exide Batteries are your only logical choice. Dry Batteries have a short life and then have to be scrapped. Exide Batteries cost less in the long run and give better results all the time.

Exide

THE LONG LIFE BATTERY

Obtainable from Exide Service Stations and all reputable dealers
Exide Service Stations give service on **every** make of battery

Exide Batteries, Clifton Junction, near Manchester. Branches at London, Manchester, Birmingham, Bristol and Glasgow

K 17

**MAXIMUM
INDUCTANCE**

assured—

Lewcos "X" Coils have now firmly established themselves as a necessity with discriminating users of radio sets. Their maximum inductance, minimum self-capacity and circuit adaptability make Lewcos Coils extremely selective, securing the best results for any circuit.

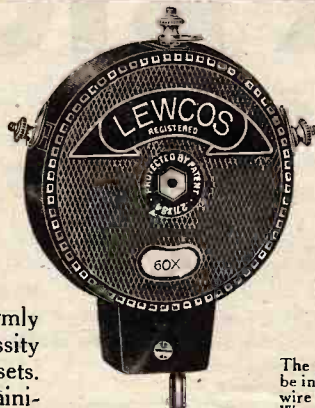

Lewcos Triple-Tapped "X" Coils. 60X and 75X. Price 4/9 each.
200X, 250X and 300X. Price 6/6 each.

Patent 271384.

**LOCAL INTERFERENCE
COMPLETELY
ELIMINATED!**

The Lewcos Rejector Wavetrap can either be inserted in series with the aerial lead-in wire and employed as an ordinary Rejector Wavetrap or, where unscreened radiating coils such as standard six-pin or "Q" Coils are employed, it may be used as an absorption wavetrap. When used in the latter manner no connections are necessary. Where extreme conditions necessitate it, a Rejector Wavetrap can be used in conjunction with an absorption wavetrap and may be used with either crystal or valve set.

For further details write for leaflet R.60.



Rejector Wavetrap. R.W.4, 235-425 metres. Price 7/6 each.
Absorption Wavetrap. A.W.5, 235-550 metres. A.W.20, 1000-2000 metres. Price 6/- each.

LEWCOS
REGD.

RADIO PRODUCTS

THE LONDON ELECTRIC WIRE COMPANY AND SMITHS LTD.,

Church Road, Leyton, London, E.10.

Trade Counter: Playhouse Yard, Golden Lane, E.C.1.

Mention of "The Wireless World," when writing to advertisers, will ensure prompt attention.

A2

PERFORMANCE PROVES THE P.M. FILAMENT-

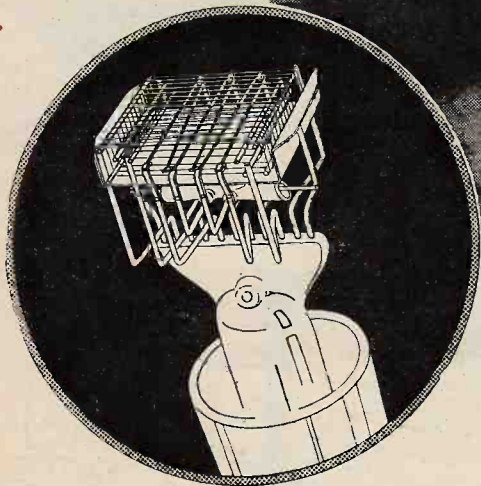

—that's how the enormous development and research on the P.M. principle can make itself known to you—through the results you obtain from your receiver with Mullard valves. Such technical improvements on the P.M. filament as

- ★ Increased Emission
- ★ Greater Efficiency
- ★ Improved Characteristics
- ★ Greater Mechanical Strength

mean incisive reception and vivid tonal purity. Act on this tangible evidence and plug a set of Mullard radio valves into your receiver to-day.

Mullard

THE · MASTER · VALVE

Advt. The Mullard Wireless Service Co., Ltd., Mullard House, Charing Cross Road, London, W.C.2.

Arks

REGENTONE D.C. or A.C.

"PORTABLE" COMBINED UNITS (H.T. with L.T. Charger)

A.C. MODEL

This is the model which has given such satisfaction in Portables of practically every make and every type.

MODEL W.5. Incorporates Westinghouse Metal Rectifiers on both H.T. and L.T. sides. SIZE—9"x5"x3½". OUTPUT—120 Volts at 15 m/a. TAPPINGS—H.T., 2 continuously variable (one S.G.) and 1 Power. L.T.—Trickle Charger for 2-, 4- or 6-volt Accumulators.

Price £5 : 17 : 6

MODEL W.6. H.T. only, £4 : 5 : 0

Either of the above models is available for 25 cycles at an increase in cost of 10/.

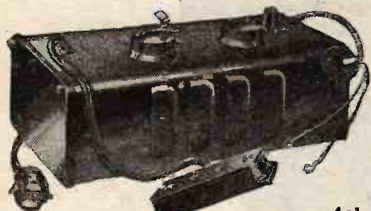

If supplied with "Extra-Point" Lampholder and Plug, 4/6 extra.

THEY FIT
INSIDE
ANY
PORTABLE

Equally suitable
for all popular
2, 3- and 4-valve
Receivers

D.C. MODEL

—the only "Portable" Combined D.C. Unit on the market.

SIZE—9"x5"x3½". INPUT VOLTAGE 200-250 volts. H.T. OUTPUT—130 volts at 20 m/a. H.T. TAPPINGS—2 continuously variable (one S.G.) and 1 power.

L.T.—Trickle Charger for 2-, 4- or 6-volt accumulators, without any alteration whatever to existing wiring.

Price £4 : 5 : 0

H.T. only, £2 : 15 : 0



Ask your dealer for demonstration or call at our London Showrooms. ILLUSTRATED LEAFLET GIVING FULL PARTICULARS ON APPLICATION.

REGENT RADIO SUPPLY CO. 21, Bartlett's Bldgs, Holborn Circus, London, E.C.4 Telephone, Central 8745/7

D.C. to A.C.

If your supply mains are D.C. you can operate an A.C. All-Electric Receiver by using the



D.C. to A.C.
ROTARY TRANSFORMER

Can be supplied to run from any voltage 12-250 V.D.C. 40 watt model £13; 85 watt model £19. Recommended and used by Philips Radio, Marconiphone, Burndept, Kolster-Brandes, M.P.A., Etc., Etc.

Write for Pamphlet 596/1 which gives full details.

THE M-L MAGNETO SYND. LTD,
Radio Dept., COVENTRY.

Telephone : 5001.



Mention of "The Wireless World," when writing to advertisers, will ensure prompt attention.

© 1930 M-L
A4

NOW IS YOUR CHANCE



to build this wonderful
RADIO - GRAMOPHONE

Universally acknowledged to be the most perfect All-mains A.C. instrument in existence.

FULL SIZE WIRING CHARTS
free to all sending 2d. postage.

READ THIS SPECIAL OFFER :—

For one month only from this date, we will supply the components for building the Receiver and Eliminator Sections of this marvellous instrument at the special prices shown below. In addition we will assemble all the components on the panel and baseboards without any charge. Further, we guarantee to refund the full amount paid if, after constructing the instrument, you are not

ABSOLUTELY DELIGHTED WITH ITS RESULTS.

State voltage and periodicity of A.C. Mains Supply when ordering.

SPECIFICATIONS

Panel and Baseboard Section.

"C.A.C." Low Frequency Coupler, A.C. Mains type, 1 $\frac{1}{7}$ henry Choke, two Polar Ideal Variable Condensers, 4 T.C.C. Fixed Condensers, Mahogany Panel, drilled and engraved, aluminium screen, bushed, slotted and drilled, 50,000-ohms Resistance and Holder, Reaction Condenser, two 5-pin Valve Holders, Grid Leak and Holder, Panel Brackets, Radio-Gramophone Switch, Terminal Strips, engraved and fitted with Terminals, one pair Lewcos Dual-range Coils with Ganging Switch for single operation, the whole mounted on baseboard.

Usual Price £11-0-6
SPECIAL PRICE FOR ONE MONTH ONLY £8 - 17 - 6

Eliminator Section.

One Mains Transformer with Variable Inputs giving Outputs of 2 amperes at 4 volts for rectifier valve, 5 amperes at 4 volts for A.C. Valves and 250 volts at 50 milliamperes H.T., two 1 $\frac{1}{7}$ henry Chokes, two 5-mfd. T.C.C. Condensers, 800-volt Test, Wire-wound Potential Divider, 24,000 ohms with five tappings, 2-mfd. T.C.C. Condenser, Terminal Strip, engraved, with Terminals, Valve Holder and full-wave Rectifying Valve, the whole mounted on baseboard.

Usual Price £17-14-6
SPECIAL PRICE FOR ONE MONTH £6 - 0 - 0

NO OTHER RADIO-GRAMOPHONE CAN POSSIBLY COMPARE WITH THIS INSTRUMENT FOR FAITHFULNESS OF REPRODUCTION. It employs exclusively the wonderful C.A.C. method of amplification, fully protected under Patent No. 324942. Those who can conveniently do so are cordially invited to pay us a visit and hear the extraordinary results obtainable.

GRAMO-RADIO AMPLIFIERS LTD.,

1a, New London Street, E.C.3

(foot of steps facing Fenchurch Street Station)

'Phone : ROYAL 4300.

Nearest Underground Station : Mark Lane.

WHAT OTHERS SAY OF THIS WONDERFUL INSTRUMENT.

"THE WIRELESS WORLD":—"The results obtained fully justify the makers' claims . . . The quality of reproduction is very pleasing . . . We were particularly impressed with the brilliance of the upper frequencies, the highest notes of the piano being reproduced without any tendency to becoming wooden. There can be no doubt that the lower frequencies are also well reproduced, but without the booming effect which often spoils moving coil reproduction."

"THE GRAMOPHONE CRITIC":—"Its results are truly remarkable . . . The demonstration we had was absolutely convincing. There was an entire absence of 'blasting,' the highest and lowest frequencies were dealt with equally, and the definition clear and absolute. The Coupler appeared to bring out each individual instrument or voice, giving a perfect balance of ensemble. Bass notes particularly rang resonant and true, and the highest treble had none of that screeching and rasping so offensive to the musical ear."

"We were so impressed that without hesitation we can confidently recommend all who are interested in the cause of purer, better reproduction to write for particulars of a truly amazing innovation."

Messrs. Dodds & Atkinson, Ltd., Radio Engineers, of 9, Station Square, Harrogate, write:—"After exhaustive tests with your Radio-Gramophone instrument, using a medium aerial, we find the quality of reproduction is all that could be desired, the high and low notes for both speech and music being reproduced with amazing fidelity. Indeed, it was difficult to realise the absence of the performers from the room in which the test was carried out. Selectivity over the whole Broadcast range was remarkable. Thirty Stations were obtained in a very short time. 'Hum' and 'mush' associated with mains instruments were absent. The volume obtained without drum bears witness to the efficient coupling of five valves."

The ideal power detector....



MAZDA L.210



With the large increase in the power of several of the B.B.C. Stations, and the knowledge that further increases will take place in the future, it behoves you to use a detector stage that is capable of handling large inputs without distortion.

The Mazda L.210 is an ideal valve for this purpose and, in addition, can be relied upon for all-round efficiency and long life.

The Amazing

MAZDA

RADIO VALVES

PRICE
10/6



THE EDISON SWAN ELECTRIC CO., LTD.,
Radio Division,
1a, Newman Street, Oxford Street, W.1.
Showrooms in all the Principal Towns.

EDISWAN

V.36

Mention of "The Wireless World." when writing to advertisers, will ensure prompt attention.

Paillard

ELECTRIC INDUCTION MOTOR

For alternating current only.
100 to 130 or 200 to 250 volts.
7 1/2 in. x 5 1/2 in. x 5 1/2 in.

Ideal for Radiograms.

NO INTERFERENCE. No Belt. No Brushes or commutator. Perfectly silent and no variation in speed of revolution, even with considerable fluctuation in mains voltage. Fitted by leading Radiogramophone Makers. Equipped with 12-inch Turntable, covered with velvet, and Automatic Brake and Cut Out.

£4.17.6 (Without Unit-Plate £4.10.0)

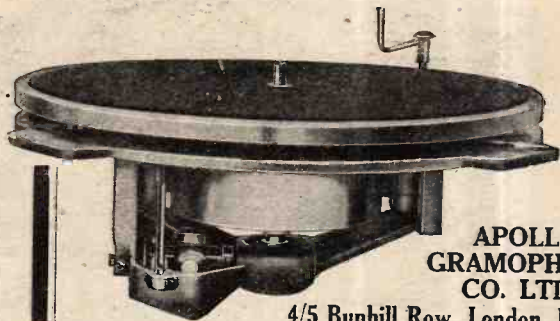

APOLLO
GRAMOPHONE
CO. LTD.,

4/5 Bunhill Row, London, E.C.1.

THE TILTATONE

(Regd.)

An instrument which allows the output curve of an Electrical Gramophone to be varied, by merely turning a single control. Volume to be reduced without cutting top frequencies. The Tiltatone enables one to subdue or accentuate the middle frequencies *without* affecting the really high or really low notes.

AMPLIFIES—CORRECTS
CONTROLS

CELESTION

The Very Soul of Music

CELESTION LTD.,
KINGSTON-ON-THAMES

R2

FERRANTI RADIO COMPONENTS



AF3
TRANSFORMER



ANODE FEED. RESISTANCE



TRICKLE CHARGER



OUTPUT
TRANSFORMER



CHOKE

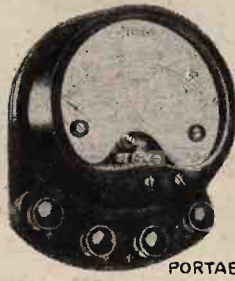

PORTABLE
RADIO METER



PUSH-PULL
TRANSFORMER



FIXED
CONDENSER



VALVE TESTER

FERRANTI LTD.

HOLLINWOOD

LANCASHIRE

USERS OF LARGE OUTPUTS

appreciate the advantages of



METAL RECTIFIERS

which are used not only for the operation of radio equipment but also for a large number of purposes—from instrument work of a few microwatts to the operation of electrical machinery, etc., up to ten kilowatts.

The absence of moving parts, electrolytes and filaments renders them more reliable, economical and easier to use than any other means of obtaining direct current from alternating current supplies.

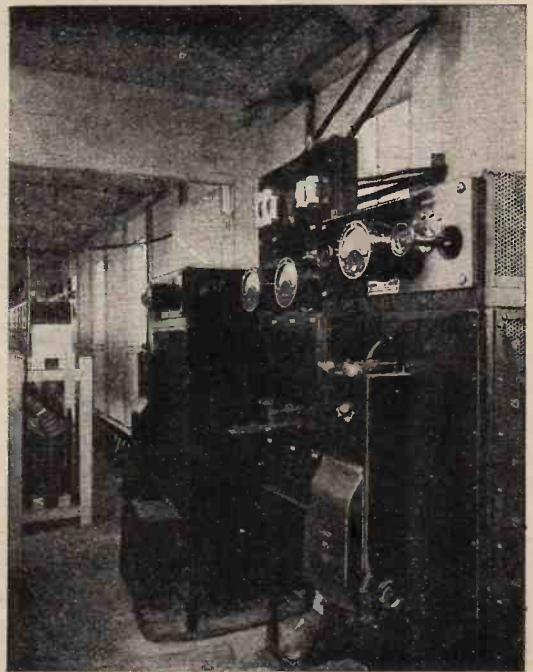

Westinghouse Metal Rectifiers in service at New Cross, Southern Railway, for charging accumulators used to operate electric point machines.

Full details and circuits for all units for radio mains equipment are given in our 32-page booklet, "The All Metal Way—1930." Send 2d. stamp for a copy to

The Westinghouse Brake & Saxby Signal Co., Ltd.,
82, York Road, King's Cross, London, N.1.

"The Rolls Royce of Radio"

ALL ELECTRIC RADIO GRAMOPHONE

Incorporating the Famous
"MELVA" Screen-Grid Receiver.

3. Stages of S.G. Detector and Pentode.

A fine instrument of magnificent quality both as to technical details and appearance. Ample power and amazing selectivity enabling upwards of 30 European Stations to be received at full loud-speaker strength anywhere in the country. Mains-driven Gramophone Mechanism of the first quality.

Ask for Catalogue giving full details of high grade Rialton Sets, or demonstrations arranged in any part of the country.

RIALTON
RADIO
"The Rolls Royce of Radio"

13-14, GOLDEN SQUARE, LONDON, W.1.



Length 38 ins. Depth 28 ins.
Height 38 ins.

Delivered and installed complete, 105 gns.

"IT'S THE TOBACCO THAT COUNTS"



*Player's
Please*



PLAYER'S "MEDIUM" NAVY CUT CIGARETTES

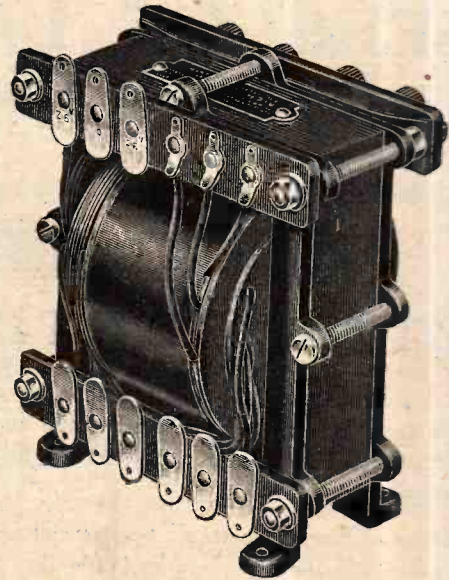

R. & B.

**MAINS TRANSFORMERS. POWER CHOKES.
AUTO-TRANSFORMERS. OUTPUT TRANSFORMERS.**

Write or 'Phone your enquiries to:-

RICH & BUNDY, LTD.,
New Road, Ponders End, Middlesex.

'Phone: ENFIELD 6777.

Mention of "The Wireless World," when writing to advertisers, will ensure prompt attention.

The Wireless World

AND
RADIO REVIEW
(18th Year of Publication)

No. 560.

WEDNESDAY, MAY 21ST, 1930.

VOL. XXVI. No. 21.

Editor : HUGH S. POCKOCK.
Assistant Editor : F. H. HAYNES.
Editorial Offices : 116-117, FLEET STREET, LONDON, E.C.4
Editorial Telephone : City 9472 (5 lines).
Advertising and Publishing Offices :
DORSET HOUSE, TUDOR STREET, LONDON, E.C.4.
Telephone : City 2847 (13 lines). Telegrams : "Ethaworld; Fleet, London."
COVENTRY : Hertford Street.
Telegrams : "Cyclist, Coventry." Telephone : 5210 Coventry.
BIRMINGHAM : Guildhall Buildings, Navigation Street.
Telegrams : "Autopress, Birmingham." Telephone : 2970 and 2971 Midland.
MANCHESTER : 260, Deansgate.
Telegrams : "Iliffe, Manchester." Telephone : 8970 City (4 lines).
GLASGOW : 101, St. Vincent Street, C.2.
Telegrams : "Iliffe, Glasgow." Telephone : Central 4857.

PUBLISHED WEEKLY.

Subscription Rates : Home, £1 1s. 8d. ; Canada, £1 1s. 8d. ;
other countries abroad, £1 3s. 10d. per annum.

Entered as Second Class Matter at New York, N.Y.

As many of the circuits and apparatus described in these pages are covered by patents, readers are advised, before making use of them, to satisfy themselves that they would not be infringing patents.

CONTENTS OF THIS ISSUE.

	PAGE
EDITORIAL VIEWS	523
UNIT H.F. STAGE. BY N. P. VINGER-MINTER	524
THE STENODE RADIOSTAT. BY S. O. PEARSON	527
A FURTHER NOTE ON CALIBRATION. BY A. L. M. SOWERBY	531
CURRENT TOPICS	534
BROADCAST RECEIVERS REVIEWED. FERRANTI A.C. MAINS SET	536
HIGH PERMEABILITY ALLOYS	538
CORRESPONDENCE	542
LABORATORY TESTS ON NEW APPARATUS.	543
BROADCAST BREVITIES	544
READERS' PROBLEMS	545

THE REGIONAL SCHEME.

A CORRESPONDENT whose letter is published in this issue, writing on the subject of the Regional Scheme, questions whether the service provided by the B.B.C. to-day is as good as it was a few years ago. It is suggested that the Regional Scheme has, so far, not worked out on the lines of giving the public the service and alternative programmes originally promised. One of the complaints of our correspondent, which is in common with that of a number of our readers who have written to us, is that there is to-day no greater variety—in fact, rather less choice, of programmes than there formerly was under the old order of things. This is because the National and Regional stations of Brookmans Park have, on occasions, broadcast the same programme, whilst very frequently they transmit programmes which are of the same character and, therefore, do not cater for different public tastes.

Before the introduction of the Regional Scheme, when many areas were served by only one transmitter, the

complaint was that listeners had no alternative programme, and that the B.B.C. was not meeting popular wishes. The B.B.C., when they now transmit the same programme from both the Regional and the National transmitters, do so because they consider that the particular programme they have to broadcast is one which would appeal to everybody: but who is competent to decide what programmes merit this special consideration? However convinced the B.B.C. programme officials may be that a certain programme ought to be acceptable to every listener, the fact remains that no such programme exists. It is not enough to say "Oh, but of course everybody would want to hear that!" and take it for granted that this individual opinion is shared by all listeners.

Duplication in the Same Area.

We sympathise with the difficulties which the B.B.C. are up against in trying to arrange for perpetual alternative programmes, but because the Regional Scheme originally set out to promise the public a choice, even occasional failure of the ideal plan is bound to provoke strong comment. We believe that the B.B.C. would themselves readily agree that in transmitting the same programme from both the National and the Regional transmitters at Brookmans Park they are falling short of the ideal which they have set themselves. Economically, also, we would contend that such an arrangement is entirely unsatisfactory, for it can safely be assumed that those who can get the Regional can also receive the National programme, and to set two transmitters in operation to pump out precisely the same programme when both the stations serve the same area would appear to be an economic blunder.

It should, in our view, never happen that two stations serving the same area should transmit the same programme.

o o o o

THE STENODE RADIOSTAT.

WE recently promised our readers that we would give a description of the Stenode Radiostat as early as possible. In this issue we include a technical description of the receiver, and give a suggested explanation of the operation of the device.

It is not claimed that this explanation is final, nor even that it is complete in itself, but we believe that it will serve to harness the practical results obtained with the Stenode to accepted theory and show that the two are by no means so irreconcilable as many critics have been inclined to regard them.

UNIT H.F. STAGE

PROBABLY the most popular broadcasting receiver in use to-day is the ordinary two-valve set consisting of a leaky grid detector with reaction followed by a transformer-coupled L.F. stage. Owing to the introduction of the Pentode valve, the volume given by such a receiver approximates very closely to that given by a similar set fitted with an extra L.F. stage. It is capable of giving excellent loud speaker results on the local and high-powered station, and *if in skilled hands* will enable quite a number of foreign stations to be brought in on the loud speaker. This type of set owes its popularity to the fact that it is comparatively inexpensive in initial cost and upkeep, and has a minimum number of controls.

Unfortunately, owing to the fact that it depends solely upon reaction for its range-getting properties, it is never entirely satisfactory for the purpose of bringing in a large number of stations on the loud speaker, because reaction has to be pushed to a limit which is incompatible with good quality, in order to obtain adequate volume on the loud speaker. On the other hand, a receiver which possesses a well-designed H.F. stage in addition to reaction shows a marked superiority from the point of view of quality, not necessarily because it enables one completely to dispense with reaction, if desired, but because so much less reaction has to be used in order to bring a distant station up to a given degree of volume than is the case when no H.F. stage is present. A well-designed H.F. stage is then a very great advantage in a receiver. Many people, however, partly on the grounds of expense, do not want to scrap a good detector and L.F. arrangement, and it is very largely for this class of people that the present unit has been designed.

An examination of the circuit diagram reveals the fact that it is adaptable for both broadcast bands by a simple switching arrangement. The selectivity can be varied according to the needs of the locality in which the set is to be used,

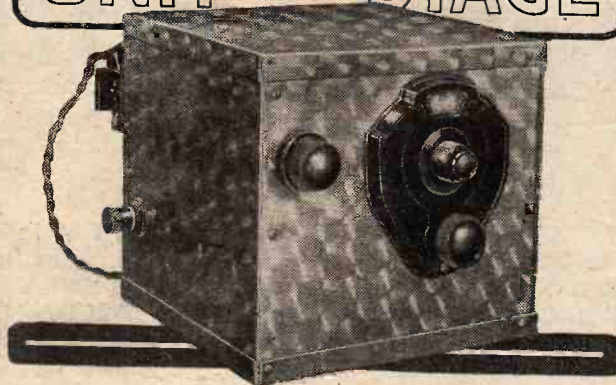

A Stable Long-range Unit of High Magnification.

By N. P. VINCER-MINTER.

unit be used in preference to the use of a variable or fixed condenser in series with the aerial lead-in. The unit recommended is the one described in an article which appeared in the issue of this journal for March 12th, 1930.

Both the aerial tuning unit and the H.F. unit under consideration are housed in the standard $6\frac{1}{2}$ in. \times $6\frac{1}{2}$ in. \times 6 in. aluminium screening boxes, which are obtainable from almost any radio dealer nowadays. These two units used in front of an ordinary Reinartz receiver form an excellent combination. Another use to which this unit can be put is to employ it for the intermediate amplifier of a short-wave superheterodyne receiver by placing it between any type of "detector and L.F." combination, and the short-wave superheterodyne adaptor which was described in the issue of this journal for April 23rd, 1930. Readers will remember that that adaptor was intended for use in front of a broadcast

receiver which possessed an H.F. stage, and it is obviously not possible to use it in front of a receiver without an H.F. stage.

A 5-pin valve holder is fitted, so that an A.C. screen-grid valve can be used if desired. In this case the link which joins the terminal of the cathode socket (centre) of the valve holder to the L.T. terminal should be removed, and the L.T. switch permanently closed. The earth terminal of the unit should be joined direct to the earth terminal of the set, as well as to the actual earth itself. No extra

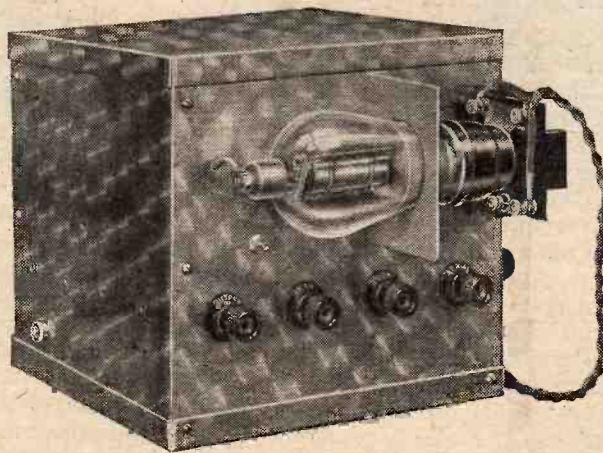

The unit viewed from the back. Note the method of mounting the valve.

Unit H.F. Stage.—

connection need be made to the cathode terminal of the valve holder. At the same time, a special 0.9-volt grid cell which is suitable for battery type S.G. valves should be replaced by a 1½-volt cell. On no account, however, should anything but a special 0.9-volt cell be used for an ordinary type S.G. valve.

When A.C. Mains are Available.

The output terminal of the unit should be connected by as short a length of wire as possible to the aerial terminal of the receiver. If there is a series aerial condenser in the receiver, the experiment of short-circuiting it should be made to see if improved results or otherwise are obtained. Provided that the same L.T. battery is used for both unit and set, no further connection is necessary. If separate batteries are used, the two earth terminals should be joined together, as previously mentioned when discussing A.C. valves. In any case no H.T. — connection is necessary, this terminal, together with the low-potential output terminal, being merely shown on the circuit diagram in order to illustrate theoretical principles. It will be noticed that twisted leads (ordinary "flex") are connected direct to the L.T. terminals on the valve holder; a "straight-through" type switch is used in this lead near the battery end. If there is likelihood of A.C. mains being used at some future date, this arrangement should be employed, as, by keeping the L.T. leads completely outside the box and, therefore, away from the coils, one serious cause of A.C. hum is eliminated. If there is no possibility of A.C. mains being used, it will obvi-

ously be more convenient to mount an L.T. switch on the front of the box, or, better still, a three-pole switch of the type used for wave-changing should be obtained instead of a double-pole one, and then it will only be necessary to put the switch to the centre position in order to switch off.

With regard to the actual constructional details, it may be said at once that this unit is as simple to build as to operate. The customary dimensional layout is

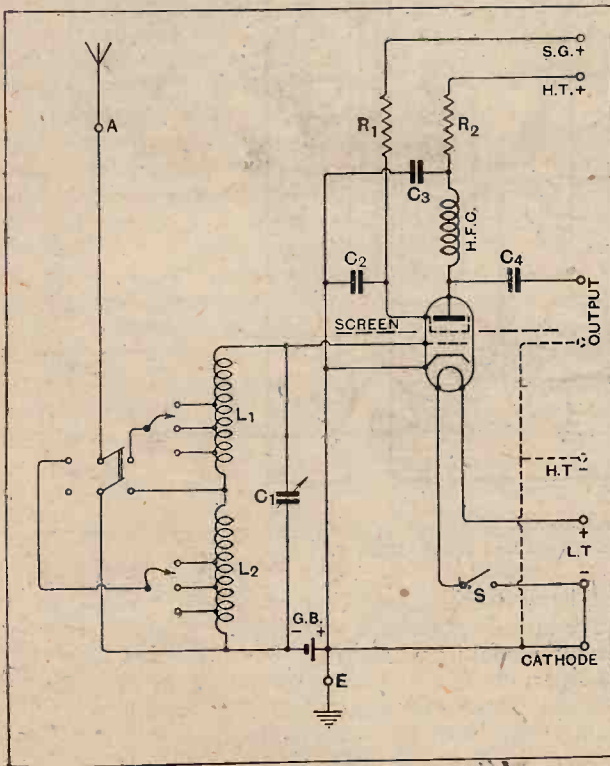
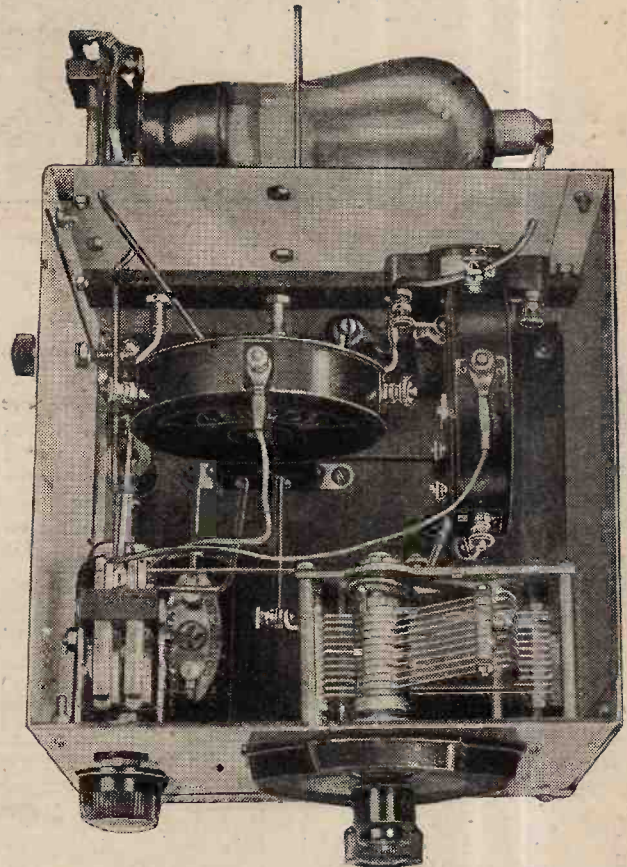

Fig. 1.—The theoretical circuit diagram. C₁, 0.0005 mfd.; C₂, C₃, 0.5 mfd.; C₄, 0.0003 mfd.; R₁, R₂, 600 ohms.

B 7



An interior view. The bias battery is beneath the tuning condenser.

not given, as the position of the various components can be easily seen by an examination of the practical diagram. Provided that the general layout is followed approximately, there is no need for any exactitude in the placing of the components. The box is sold in parts and is easily assembled with the nuts and bolts provided, the wooden baseboard being held fast by screws passed through the bottom of the metal container. The method of erecting the box will be quite obvious to anybody with the parts in front of him, and calls for no further comment.

All the baseboard components should be mounted and wired up as far as possible before completing the box. The variable condenser and the switch on the front, and the terminal strip on the back, should be mounted before the box is completely assembled. No part of the variable condenser must be allowed to come into contact with the box, or the grid battery will be short-circuited. This difficulty is overcome by drilling

LIST OF PARTS.

- | | |
|--|---|
| <ul style="list-style-type: none"> 1 Standard aluminium box with baseboard, $6\frac{1}{2} \times 6\frac{1}{2} \times 6$ in. (Peto-Scott). 1 D.P. D.T. switch ("Eureka," L. Person & Son, 63, Shaftesbury Street, London, N.1). 2 Fixed coil holders (Lotus). 2 Tapped plug-in coils, No. 60 X and No. 200 X (Lewcos). 1 0.0005 mfd. variable condenser (Lotus). 1 Vernier dial ("Dominion," Brownie Wireless Co.). 2 600 ohm decoupling resistances (Wearite). 2 0.5 mfd. non-inductive fixed condensers (Hydra). | <ul style="list-style-type: none"> 1 0.9 volt grid bias cell (Siemens). 1 Binocular H.F. choke (Walmel, DX3). 1 5-pin valve holder (Junit H.V.). 1 0.0003 mfd. fixed condenser (C.D.M.). 5 Ebonite shrouded terminals (Igranic). 2 Spade ends (Lisenin). 1 "Straight through" type switch (Grafton). |
|--|---|

Approximate cost £2 10 0.

In the "List of Parts" included in the descriptions of *THE WIRELESS WORLD* receivers are detailed the components actually used by the designer and illustrated in the photographs of the instrument. Where the designer considers it necessary that particular components should be used in preference to others, these components are mentioned in the article itself. In all other cases the constructor can use his discretion as to the choice of components, provided they are of equal quality to those listed, and that he takes into consideration in the dimensions and layout of the set any variations in the size of alternative components he may use.

a large clearance hole for the condenser bush; an oblong piece of ebonite having a thickness of $\frac{1}{8}$ in. is screwed to the back of the box front by nuts and bolts, and the condenser is actually mounted on this, using the one-hole fixing method. Similarly, a $\frac{3}{16}$ in. ebonite strip is mounted on the inside of the back of the box, and large holes are drilled in the aluminium in order to clear the shanks of the four terminals. The wiring is carried out

ever in the case of this unit owing to careful design. The method of mounting the valve holder is obvious. It is a type specially made for mounting in the manner shown. No dimensions are given for the small aluminium shield through which the valve is passed, as the position of the hole depends on the amount by which the valve holder projects from the back of the box, and it is realised that many readers may care to use valve

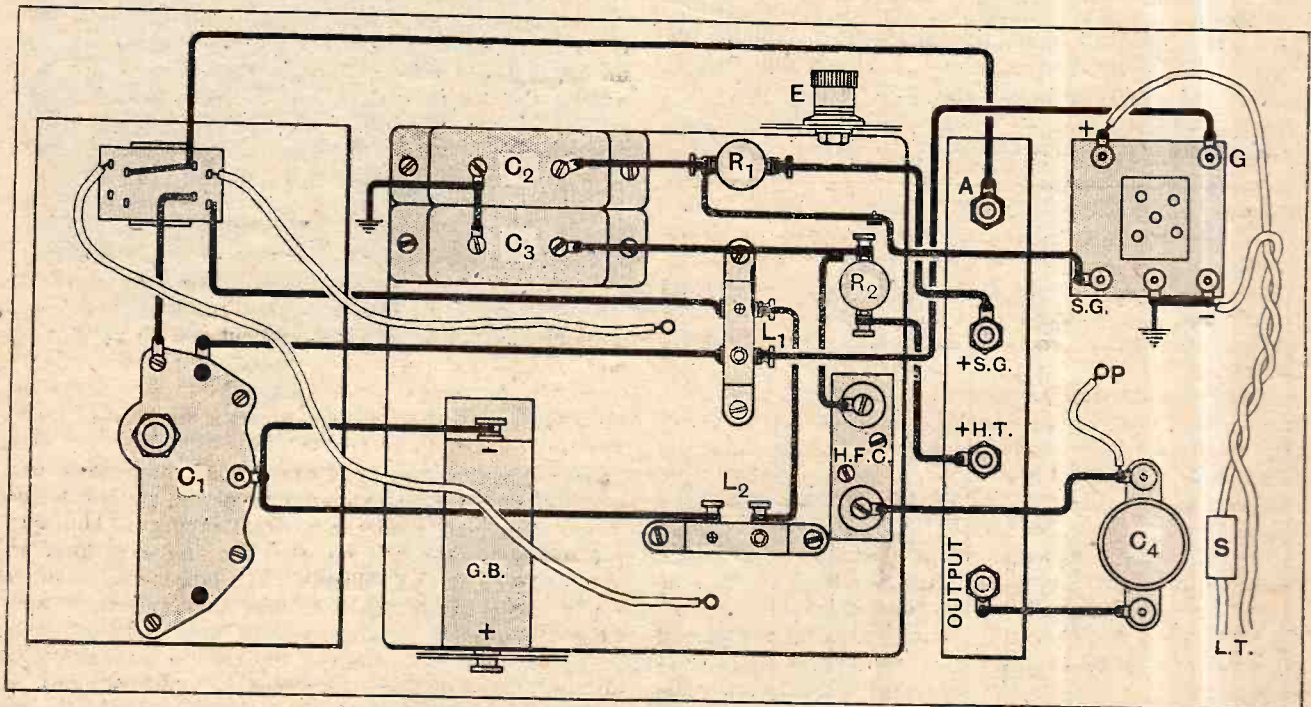
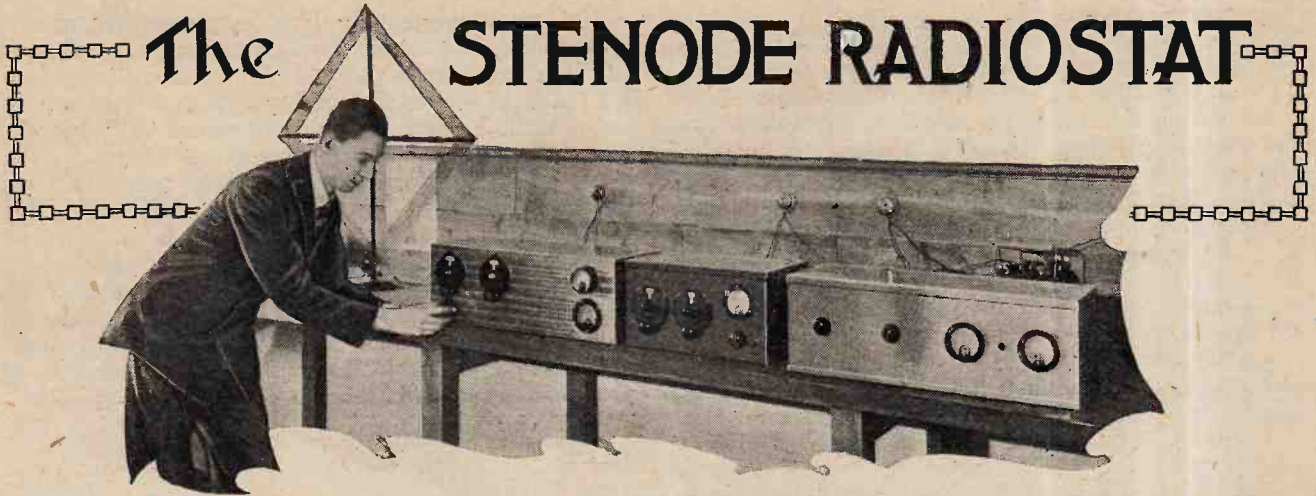

Fig. 2.—Practical wiring plan. Note the position of the switch S.

with glazite, and connections are kept as short as possible; most of them should be made before the box is completely assembled, and then no difficulty will be encountered. The positive terminal of the grid battery passes through the side of the screening box, this forming both a mechanical support and an electrical connection, as the screening box is used as the earth return where possible, this conferring no disadvantage what-

holders of other dimensions which they may happen to have in their possession. If desired, it may be obtained ready made from the makers of the screening box. Needless to say, it should be placed in line with the internal screen of the valve. This small screen, in conjunction with the valve holder, acts as a mechanical buffer, so that the unit may be pushed right back against a wall without fear of damage to the valve.



A Suggested Explanation of the Principles Involved.

By S. O. PEARSON, B.Sc., A.M.I.E.E.

IN the issue of *The Wireless World*, dated December 11th, 1929, a short note was given introducing to readers the super-selective receiving set, designed by Dr. James Robinson, and known as the "Stenode Radiostat." On that occasion a hint was given as to the main principle on which the operation of the receiver depended, but a detailed explanation had to be withheld on account of the patent situation. Now that this restriction has been withdrawn, it is possible to give full details of the principles involved, and a description of the apparatus itself together with a complete circuit diagram.

The outstanding feature of the receiver is that the tuning is so sharp that an interfering station, whose carrier-frequency is less than 1 kilocycle per second off that of the desired transmission, can be completely eliminated without producing high-note loss. The effects of excessively sharp tuning in an ordinary receiver are so well known that no more than a brief reference is needed here; as the selectivity is increased by reducing the damping of the tuned high-frequency circuits, the lower notes in the audible range are accentuated relative to the higher ones, and the reproduction becomes "woolly." This effect is not present in the Stenode receiver, all frequencies being reproduced in their proper proportion, in spite of the fact that the tuning is very much sharper than anything obtained hitherto.

In face of the generally accepted sideband theory of modulated waves, an announcement such as this was bound to be received with a certain amount of scepticism, because it apparently repudiates the sideband theory. But this is no doubt only apparent. It is argued that there must be a fallacy somewhere when a claim is made to be able to eliminate a 1,000-cycle unwanted beat-note and yet retain all frequencies of the desired transmission up to 5 kilocycles or more. The first impression one gets is that either the claim is extravagant, or, if the claim is substantiated, there must be something wrong with the sideband theory. However, on closer investigation it would appear that

the performance of the receiver might be explained without any contradiction of the sideband theory of modulated waves. In fact, the sideband theory might be applied to it to explain its action just as in the case of a normal type of receiver, but new importance is given to a certain aspect of heterodyne interference, namely, that an interfering frequency producing a heterodyne beat-note in the ordinary way does not have the same effect on the carrier wave as a pair of side-frequency components representing a single low-frequency modulation. This point will be referred to again.

Inertia in Tuned Circuits.

On the other hand, the action of the receiver can probably be more easily explained in terms of the other theory of modulated waves, namely, by treating a modulated wave *as such*, without imagining it to be split up into its equivalent components. According to this theory, the high notes in a normal receiver are attenuated relatively to the low ones, due to the inertia effects in the tuned circuits; *but the number of high-frequency oscillations per second in the modulated wave are exactly the same as the number of oscillations per second in the unmodulated carrier wave.* (The term "frequency" has been avoided here because some will object that, strictly speaking, "frequency" can be applied only to a wave which repeats itself exactly cycle by cycle.)

It was along this line of thought that Dr. Robinson directed his efforts in developing the Stenode, and all those who have witnessed a demonstration of the experimental model agree unanimously that these efforts have been crowned with the greatest success, and that the new principle promises to have very far-reaching effects not only in radio telephony, but also in wireless and line telegraphy.

When a high-frequency voltage is suddenly applied to a tuned circuit having a very low decrement, that is to say, very little damping, the current oscillations in it build up to a considerable strength, but it takes

The Stenode Radiostat.—

a comparatively long time for the amplitude to reach any given fraction of the final steady value towards which it is tending; in other words, the circuit possesses a fairly long time-constant. On the other hand, when the energising voltage is suddenly removed the oscillations take some time to die away.

From this it is evident that when an amplitude-modulated high-frequency voltage is applied to the circuit, the sluggishness of the latter will tend to suppress the variations of amplitude as regards the current in the circuit. The higher the frequency of modulation the greater will be the resulting attenuation of the low-frequency components, and so, on the whole, the lowest frequencies of modulation will have excessively high amplitudes compared with the highest ones.

In dealing with a tuned circuit to which a modulated high-frequency voltage is applied, the same conclusions are arrived at whichever of the two theories is adopted, namely, that the lowest frequencies of modulation are accentuated relatively to the higher ones as far as the resulting current is concerned. The sideband theory has been more generally used simply because its application is comparatively simple, and the majority of those engaged in wireless work have acquired the habit of always thinking of a modulated wave in terms of its equivalent components. Although some of us have been at great pains to prove experimentally that the side-frequency components do actually exist, the success of these experiments does not disprove the existence of the modulated wave intact.

A resonating system of any kind is one which has the property of responding more to one particular frequency than to any other, and if such a system is tuned to any one component frequency of a complex alternating force, whether it be mechanical or electrical, the resulting vibration set up in it is also a complex one, but the relative amplitudes of the component frequencies have been changed, the one at the resonant frequency being greatly accentuated.

An Interesting Comparison.

In listening to the note of a violin we usually imagine it as a complex vibration—we have not got into the general habit of thinking of it in terms of its equivalent fundamental sine wave and series of harmonics. But if we took the same trouble to prove the physical existence of these harmonics as we have done for modulated waves, we should find them all there. If the sound wave from the violin is allowed to impinge upon the blade of a tuning-fork whose natural frequency is equal to, say, the third harmonic of the violin's note, the fork will show a large response to that particular component frequency of the complex wave, and practically no response to the remaining component frequencies.

The fact that in the case of a modulated high-frequency wave the ratio of any component side-frequency to the basic frequency is very nearly unity whereas for the complex low-frequency wave the ratio of any harmonic-frequency to the fundamental is a whole number other than unity does not in any way affect the principles involved.

The knowledge that the high-frequency variations in a modulated wave pass through the same number of complete reversals per second as the carrier wave itself led Dr. Robinson to the conclusion that if the receiving circuit could be sufficiently sharply tuned, any unwanted wave on a neighbouring frequency, even if removed by a few cycles only, could be effectively eliminated. At the same time he realised that the use of such a sharply tuned circuit would necessarily result in enormously accentuating the lower note-frequencies, so that, in the reproduction, the higher frequencies would be comparatively so weak as to seem practically non-existent, and that therefore some means would have to be provided for preventing the lower notes from getting out of proportion as regards relative strengths.

Details of the Receiver.

It is in these two respects that the Stenode Radiostat differs in principle from any orthodox type of receiver, namely, the provision of a means of effecting razor-edge tuning together with a compensating device for maintaining the proportionality of the various low-frequency components of the modulated wave without reducing the sharpness of tuning.

The necessary sharpness of tuning is effected by the use of a quartz crystal, the piezo-electric properties of which are already well known. Quartz crystal is perhaps among solids the one which has the most perfect mechanical elasticity, and if a suitably shaped piece of such crystal is set into longitudinal and transverse vibration by striking it, the vibrations persist for a considerable time. If the vibrating crystal is mounted between two metal plates an alternating potential difference is set up between the plates at a frequency equal to that of the mechanical vibrations within the crystal. On the other hand, if an alternating voltage whose frequency is equal to the natural frequency of vibration of the crystal is applied between the plates violent mechanical vibrations are set up in the crystal.

In the Stenode a quartz resonator embodying these principles comprises the main tuning device in the last intermediate frequency stage of an otherwise normal superheterodyne receiver. The complete circuit diagram of the latest demonstration model is given in Fig. 1, the position of the quartz resonator in the circuit being clearly shown immediately preceding the anode-bend detector, which has a conventional tuned-grid circuit.

The use of the superheterodyne principle is absolutely essential because a quartz resonator has a fixed natural frequency and so cannot itself be tuned to stations having different wavelengths—the frequency of each station received has to be transposed to the resonant frequency of the crystal. The intermediate frequency used is 100 kilocycles per second, corresponding to a wavelength of 3,000 metres. There are thus only two tuning controls in the receiver, one to tune the frame aerial to the wavelength of the station to be received and the other to tune the local oscillator to produce a supersonic beat-frequency of 100 kilocycles per second.

The three-electrode valve on the extreme left of the diagram is the local oscillator, and the next one (screen-grid) is the first detector. An idea of the extreme sharpness of tuning will be obtained when it is pointed

The Stenode Radiostat.—

out that the 0.0003-mfd. condenser for tuning the local oscillator has in parallel with it a variable condenser of not more than 10 micro-microfarads, which is itself controlled by a slow-motion dial, and that a quarter of a turn on this dial is sufficient to tune right through a station. One complete turn represents a change of one micro-microfarad only.

Preventing High-note Loss.

We turn now to the method of maintaining correct proportionality as regards the amplitudes of the various audio-frequency components in the output circuits, under conditions when ultra-sharp tuning is effected in one of the intermediate-frequency stages. Two separate and distinct methods have been tried out, and both have proved successful. The first of these is the one

diagram. It consists essentially of a high-pass filter designed to have a frequency characteristic of such a shape as to compensate as nearly as possible for the excessive magnification of the lower modulation frequencies by the quartz resonator.

It is this system which is used in the latest demonstration model, a photograph of which is seen in the title illustration. The receiver is divided into three distinct sections each housed in a metal screening box. The one on the left contains the high- and intermediate-frequency stages of the superheterodyne portion; the centre one holds the quartz resonator with its associated high-frequency transformer and condensers, together with the second detector valve and tuned-grid circuit; the one on the right contains the low-frequency amplifier and the special compensating filter. The frame aerial is seen on the left of the picture.

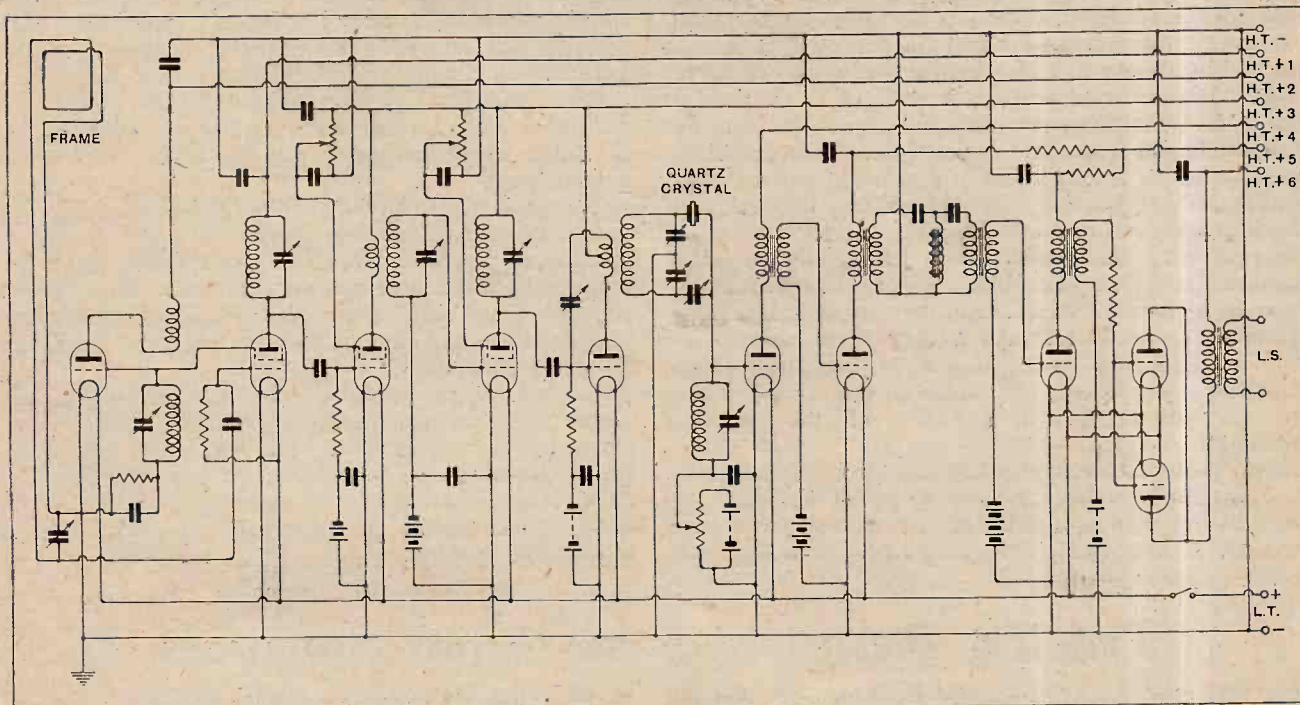

Fig. 1.—Circuit diagram of the Stenode Radiostat which is essentially a quartz crystal-controlled superheterodyne receiver with provision in the L.F. amplifier for frequency correction. The first valve is the local oscillator and the second a screen-grid first detector. There are three valves in the intermediate-frequency amplifier followed by an anode bend detector. Note the high-pass filter between the first and second L.F. stages.

referred to in *The Wireless World* of December 19th, 1929, a system of phase reversal at a supersonic frequency being introduced in the intermediate-frequency stages to eliminate the effects of the long time-constant in the quartz resonator circuit.

Since the previous announcement was made considerable progress has been effected towards simplifying the receiver; it has been found possible to eliminate the complications of having to reverse periodically the phase of the high-frequency oscillations applied to the quartz resonator. In the later type no compensation whatever is provided in the high- or intermediate-frequency stages, but a special filter circuit is included between the first and second valves in the low-frequency amplifier, its position being clearly seen in the circuit

Reviewed as a whole, then, the receiver resolves itself into one of extremely high selectivity, with a tone corrector incorporated in the low-frequency amplifier, and perhaps one may be forgiven for entertaining the idea that similar results might be obtained by more ordinary methods without the quartz resonator. But when we come to consider the matter quantitatively we arrive at the conclusion that this possibility is very remote. For instance, the decrement of the crystal in use is given as roughly 0.00004, whereas for an efficient tuned circuit of the ordinary kind at a wavelength of 3,000 metres without the use of reaction the decrement is of the order of 0.03. It would be hopeless to attempt to use critical reaction to lower the decrement sufficiently, on account of the inevitable instability that

The Stenode Radiostat.—

would result. The great advantage of the quartz resonator is that both its frequency and decrement are fixed, enabling the compensating filter to be accurately designed.

The Sideband Theory.

In reading through the foregoing brief description there is little doubt that at the back of the minds of most readers there has persisted the question: "Yes, but how can this performance possibly fit in with the sideband theory?" There is no doubt whatever that the theory is quite sound—the whole system of modern radio-telephonic practice is based upon it.

In view of these facts the writer offers the following as a possible explanation of the performance of the Stenode Radiostat in the light of the sideband theory. If a high-frequency wave of frequency f cycles per second is modulated so that its amplitude varies about the mean value at an audio-frequency of F cycles per second according to a simple sine law it is well known that this modulated wave is equivalent to the sum of *three* high-frequency waves each having a constant amplitude and frequency. One of these has a frequency of f cycles per second equal to that of the carrier wave, and the other two have frequencies of $f - F$ and $f + F$ cycles per second respectively. The point to be stressed here is that a modulated wave such as this *cannot be resolved into less than three components*. Besides the carrier frequency, there are always two separate component frequencies for each component or harmonic of the low-frequency wave, and when all these high-frequency components are combined there is absolutely no variation in the "frequency" of the resultant modulated wave.

Now, when heterodyne interference is produced by an unwanted carrier wave setting up an audible beat-note in conjunction with the carrier wave of the desired station, there are only *two* component high-frequencies

involved. By adding two such waves together it can be shown that the resulting modulated wave does not have a constant frequency. In other words, when *two* high-frequency waves are added together the resulting wave is not only modulated as regards amplitude, *but as regards frequency also*.

In ordinary tuned circuits the tuning is so flat compared with that of the Stenode that a slight amount of frequency modulation is neither here nor there. With the Stenode, however, the tuning is so sharp that even a small amount of frequency modulation, or "frequency wobble," in the carrier wave of the station being received renders satisfactory reception impossible. It is one of the main features of the Stenode Radiostat that the transmitting station to which it is tuned must be crystal controlled or possess other means of ensuring that the carrier frequency is not affected by the modulation. A crystal-controlled station, such as Rome, can be perfectly satisfactorily tuned in with very good quality, but one such as Toulouse, where a certain amount of frequency modulation exists, cannot be received with good quality, and occasionally it cuts out altogether when an excessive frequency wobble occurs. A station whose frequency wanders slightly cannot be kept in tune.

This particular behaviour of the receiver would appear to confirm the explanation given above that the usual side-frequencies of an amplitude-modulated wave are retained, whilst a beat-frequency produced by a station slightly to one side of the desired one as regards frequency is entirely cut out because this latter results in frequency modulation.

Judging by the sound of atmospherics, one would gather that the receiver is capable of dealing very efficiently with transients. The sounds produced by the atmospherics are very sharp and crisp crackles, and yet over the lower register of the musical scale the bass notes of instruments are very well reproduced from a moving-coil speaker.

Tracing Resonances in Loud Speakers.

THE presence of a resonant frequency in some one or other of the parts of a loud speaker is a not unknown phenomenon; it may be due to the paper cone, to a loose wire, to a screw or nut that has worked itself loose, or to any one of a dozen other causes. The audible symptom is usually a rattle or buzz that occurs only at certain notes in music.

While a buzz of this kind is usually easy enough to remedy, once the cause is found, it is generally surprisingly difficult to locate, for it seems to come from all parts of the speaker at once. Nor is the search made easier by the fact that the objectionable noise is only intermittently excited by one particular note, for by the time one has realised that the speaker is buzzing again the note is over, and the buzz has stopped before one has had any chance of tracing it.

A little judicious law-breaking comes to our rescue here. If the receiver is set oscillating, and the tuning is varied until the beat-note between it and a station

has the pitch that produces the buzz, one can go over the buzzing speaker at leisure and trace the noise, now made continuous, to its source. The tuning of the oscillating receiver must be carried out with extreme slowness, for the beat-note will pass over the whole audible range in response to a mere touch on the tuning dial. With a slow-motion condenser, however, there is seldom any real difficulty in finding the note to which the speaker responds.

In carrying out this test, consideration for one's neighbours makes it essential to disconnect the aerial before setting the receiver oscillating on the wavelength of the local station. If the listener lives at some distance from the nearest station it may be found impossible to obtain a sufficiently loud beat-note with no aerial; in such a case the receiver should be tuned to a foreign transmitter, and on no account to the one upon which the district as a whole depends for its programmes.

A. L. M. S.

A Further
NOTE ON

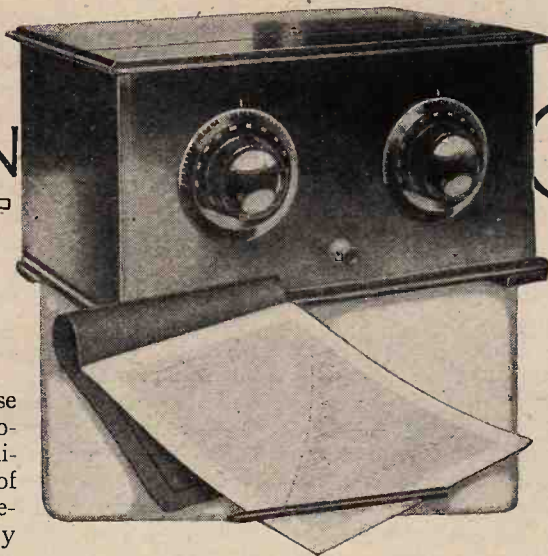

CALIBRATION

Apparent Trifles
That Make
All the Difference.

By
A. L. M. SOWERBY,
M.Sc.

A RECENT article in these pages¹ described a progressive means of calibrating the main tuning dial of a receiver in wavelengths or frequencies. In that article fairly explicit directions were given in the hope of tempting even those who had previously regarded the task of calibration as a difficult one to overcome their doubts and to have a shot at the business. Partly with that aim in view, and partly to avoid continual digressions, the various sources of possible uncertainty in the calibration were hardly mentioned. The present note represents an endeavour to amplify the earlier article.

It is not to be understood that there is any particular difficulty in making the calibration curve, for that is not the case; the point is that the curve, when made, may some weeks later be found to be seriously inaccurate. It will be our business to discuss how such inaccuracy arises, so that, being forewarned against it, we may avoid it entirely.

The calibration made by tuning in a number of stations of known wavelength registers the setting of the receiver that corresponds to each of the individual wavelengths tuned in, and from these, by drawing a curve on squared paper through all the points found, the settings of the dial for intermediate wavelengths are also determined, so that, finally, the whole tuning range is covered without a single gap. The curve is thus undoubtedly right when first made. Provided that no change of any kind is made in the receiver, and that it is subjected to no external influence that will cause it to vary its

behaviour, it will continue indefinitely to tune to each wavelength at the setting expressed by the curve. But if the receiver is altered in any way, knowingly or unknowingly, after the curve is made, the setting of

the tuning dial for any particular wavelength will usually change to a greater or lesser amount, with the sad result that the curve so carefully compiled can no longer be relied upon. We must, therefore, try to make the calibration under fixed and reproducible conditions, so that whenever the curve is to be used for finding or identifying a distant station we may be certain that the receiver is in all respects exactly as it was during the making of the curve.

The Effect of Reaction.

The receiver that was used as an example of calibration was one of the portable type with a single stage of high-frequency amplification using a screen-grid valve, and with reaction into the detector circuit. Fig. 1 does not pretend to be an exact copy of the connections of the receiver used, but it shows the main points correctly. The dial that was chosen for calibration was that controlling the grid circuit of the detector, even in face of the fact that the setting of the dial for any given wavelength was found to depend to a small extent upon the position of the reaction control.

This choice was made because it was found that with maximum reaction (receiver nearly, but not quite, oscillating) the tuning of this circuit could be made very sharp indeed. The frame-tuning was at all times flat enough to make it difficult to decide within a degree or so the exact setting that gave loudest signals from the

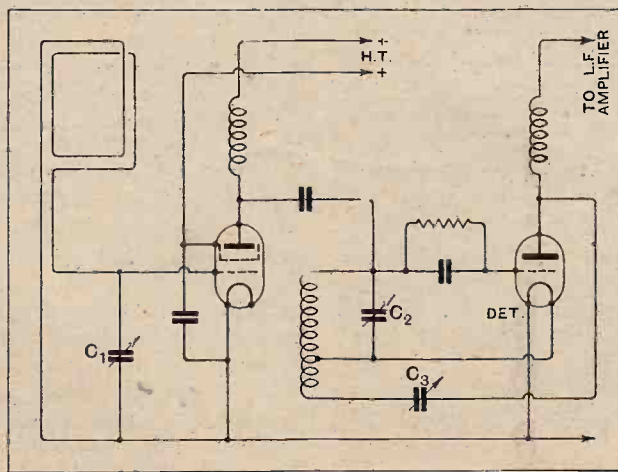

Fig. 1.—Circuit of a portable receiver, the second tuning dial of which (C₂) was calibrated in wavelengths. Variations of the reaction condenser C₃, and other causes, can render the calibration unreliable unless care is taken.

¹ "Every Set its own Wave-meter," *The Wireless World*, April 16th, 1930.

A Further Note on Calibration.—

station being heard. The possibility of errors arising through applying reaction to a different extent on different occasions was minimised by making all readings with the set on the verge of oscillation.

There are, however, still opportunities for errors to creep in and derange the calibration. The trouble is that the tuning condenser whose readings we have noted is not the only provider of capacity in the tuned circuit. Both the screen-grid valve and the detector are connected in parallel with the condenser, and there is, in addition, the complex effect due to the reaction condenser and the reaction coil. If the capacity contribution made by any of these is allowed to vary, there will have to be a corresponding alteration in the setting of the tuning condenser to compensate for it.

Change of Capacity with Change of Valve.

If the screen-grid valve is changed for another, whether of the same make or not, there is no guarantee whatever that the new valve will have the same anode-screen capacity as the old one. There will, therefore, be a new and slightly different "stray" capacity from this source, so that the calibration will be upset a little. Replacing the detector valve will have a similar effect. The influence of altered high-tension or filament voltage is less obvious, but still cannot be ignored. As the batteries grow old, it will be found that the reaction condenser has to be turned farther and farther round before the point of oscillation is reached, so that the calibration curve will depend to a small extent on the con-

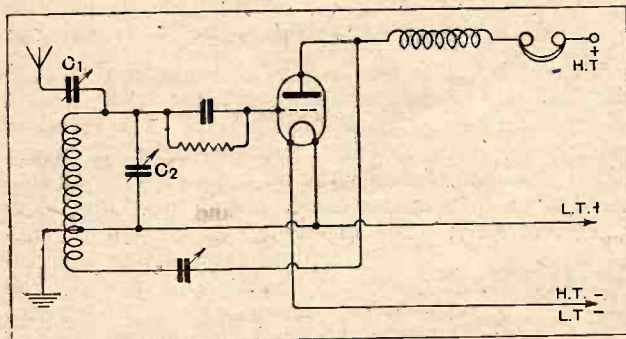

Fig. 2.—If the tuning dial (C_2) of the single-valve set here shown is to be calibrated, some attention must be paid to the setting of C_1 and to the aerial-earth capacity.

dition of the batteries." The battery voltage plays a second part, in that the effective capacities of the two valves will depend to a small extent on their working voltages. The change due to this cause may be in the same direction as that brought about by the concurrent need of readjusting the reaction condenser, or it may be in the opposite direction, so that the two effects cancel out more or less completely. As a result, the calibration may be almost independent of battery voltage, or it may, on the other hand, be quite appreciably controlled by it.

When Using a Frame Aerial.

It is to be noticed that all these possible sources of variation can be traced down to small capacity changes.

This being the case, one would expect that at the upper end of the tuning range, where the tuning condenser provides perhaps 90 per cent. of the total capacity, their effect in altering the calibration would be quite small, while at the other end, where stray capacities preponderate, their effect would be much greater. In practice it is found that quite considerable alterations may be made to the set without appreciably changing the setting required for a 500-metre station, but that the same alterations will move a 250-metre station four or five degrees one way or the other on the tuning dial.

If we had chosen to calibrate the condenser tuning the frame, we should have had to pay attention to much the same points, and, in addition, we should find that if any large object, and especially any metal object, was allowed to come near the frame, the tuning would be affected. There have been cases where a frame has been stood against a mirror (the reflecting surface of which is metallic) with the result that stations have made their appearance ten or even twenty degrees away from their appointed positions on the dial. But so long as one is aware of this source of difficulty it is very easily avoided.

With receivers where no high-frequency stage is employed, and an ordinary aerial is used, there are other possible sources of trouble in addition to those already mentioned. These additional ways in which an accurate calibration curve can cease to represent the behaviour of the receiver all depend, directly or indirectly, upon the aerial.

The Capacity of the Aerial.

Fig. 2 shows a single-valve set in which the aerial is connected through a semi-variable condenser to the upper end of the tuned circuit. Here the aerial provides a very considerable fraction of the total tuning capacity in use. The tuned circuit, in fact, may be "boiled down" to the equivalent form of Fig. 3, in which C_1 and C_2 represent the same components as in Fig. 2, while C_3 stands for the inter-electrode capacity of the valve. C_0 represents the capacity between the aerial and the ground beneath it, between the lead-in and the wall of the house, and all other such possible pairs of conductors. With an out-door aerial of moderate size C_0 usually has a value of about 0.0003 mfd. This capacity is in series with C_1 , the two together being in parallel with the tuned circuit. If C_1 were short-circuited (or made very large) the total capacity provided by the two would be equal to C_0 alone, while if C_1 were very small compared with C_0 the total capacity would not differ greatly from that of C_1 alone. Variations of C_1 can therefore change the total contribution of capacity from a minimum value a little less than the minimum to which C_1 can itself be adjusted up to a maximum which is the capacity of the aerial alone.

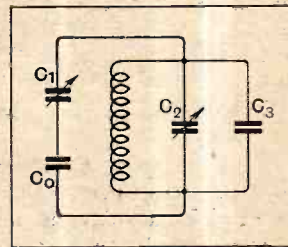

Fig. 3.—From the point of view of calibration, this simpler circuit may be taken as equivalent to the corresponding parts of Fig. 2. C_0 represents the capacity between aerial and earth.

A Further Note on Calibration.—

Now, the average listener, quite rightly, regards C_1 as a coupling condenser which is varied, as required, to control the coupling between the aerial and the set. While this is undoubtedly the function that C_1 was intended to perform when the designer of the set decided to put it in, the effect that we have just seen it to have on tuning must not be overlooked. If it is increased in capacity C_2 must be reduced in order to keep the total capacity constant, and vice versa, so that before calibrating a set of this type C_1 must be adjusted to a suitable value, and then left severely alone for good and all.

It will be clear from what has been said that it is not enough to keep C_1 constant; in addition, C_0 must not vary. Apart from alterations in the aerial itself, such apparently irrelevant matters as fitting a new gutter or water-pipe near the down-lead, or the spring sprouting of the tree to which the far end of the aerial is attached, may have an appreciable effect on the setting of the tuning condenser that a given station demands. In short, if any large object is allowed to approach more closely to the aerial, or is removed to a greater distance from it, the overall aerial-earth capacity represented by C_0 will change and upset the calibration of C_2 .

Stepping Down the Aerial Capacity.

Another type of aerial-coupling is shown in Fig. 4, where the series condenser is omitted and the aerial is connected to a primary wound over the main tuning

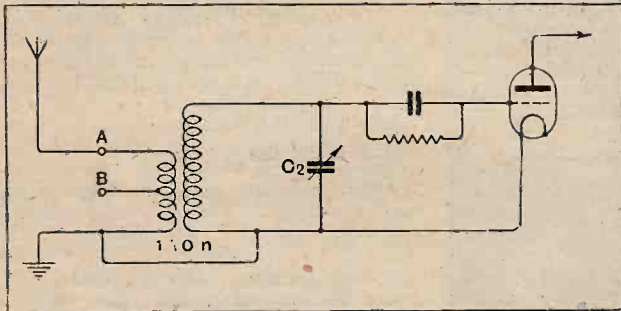

Fig. 4.—Another means of coupling the aerial to the tuned circuit. This arrangement, with fixed coupling between primary and secondary, shares with that of Fig. 6 the distinction of being the circuit best adapted to calibration.

coil. So far as variations in the aerial itself, or its immediate surroundings, are concerned, this circuit is susceptible to changes in the same way as that of Fig. 2, though usually to a lesser extent. The equivalent circuit to Fig. 4 is shown in Fig. 5, where n represents the ratio of turns between the tuning coil proper and the aerial primary. It will be seen that the step-up of 1 to n in the transformer results in stepping down the aerial capacity in such a way that C_0 connected across the primary becomes equivalent to $1/n^2$ times that capacity connected across the secondary.

Thus the contribution made by the aerial to the total tuning capacity depends on the aerial capacity itself, as before, and also upon the ratio between primary

and secondary turns in the aerial-grid transformer. It is quite common for the primary to be tapped to provide variable selectivity, and many have found it desirable to use the full primary for the upper part of the waveband, but to connect the aerial to the tapping-point when receiving stations of lower wavelength. This practice need not be abandoned if it is decided to calibrate the tuned circuit; all that is necessary is that the aerial should be shifted from A to B at some definite point in the waveband, and that the wavelength at which the change is made should be noted on the calibration curve. The change being a reproducible one, it can quite safely be allowed for by making the calibration curve under the conditions to be used in reception afterwards.

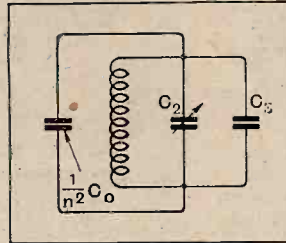

Fig. 5.—A simplified equivalent of Fig. 4. The ratio of turns (assuming close coupling) in primary and secondary of the aerial-grid transformer is n .

In cases where the primary and secondary coils are not built into one component, but are separate, it will, of course, be necessary to arrange that the coupling between them is fixed and invariable. Closer coupling, keeping the number of turns unchanged, is equivalent to altering the number of turns

while keeping the coupling unchanged, but suffers from the drawback, from our present point of view, that the position of coupling chosen for the calibration is not easily reproduced on subsequent occasions when it is desired to make the fullest use of the calibration for finding a station.

Auto-coupling.

The arrangement of Fig. 6, where the aerial is tapped into the coil instead of being connected to a separate primary, is equivalent to Fig. 4, and the same precautions must be observed and the same small liberties may be taken.

Although it is not thought that attention has been drawn in this note to all the possible small changes that may take place in a set after a calibration curve has been made, yet it is hoped that the most likely ones have been mentioned. In any case, enough has been written to emphasise that, once a tuning dial has been calibrated in wavelengths, care must be taken to keep the tuned circuit, and everything connected to it, as nearly unchanged as possible. If proper attention is not paid to this point the calibration curve will no longer hold good, and much of the time and trouble devoted to its preparation will have been wasted.

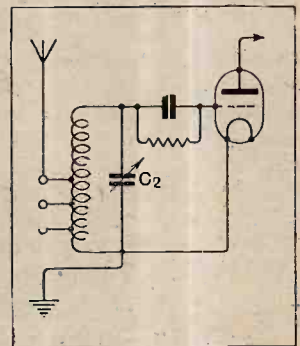

Fig. 6.—A mode of coupling the aerial to the tuned circuit which is practically identical in its results with that of Fig. 4.

CURRENT

TOPICS

LISTENING FOR JOBS.
The experiment of broadcasting offers of employment from the Tokyo station is giving great satisfaction to the Japanese Government. Since September last the station has regularly broadcast information regarding the labour market, with details of situations vacant.

SHORT WAVES FROM RABAT.
Rabat, Morocco, already famous for its broadcasting station, is to have a short-wave transmitter. The apparatus is already nearing completion, and tests will probably begin on June 15th.

ILLICIT TRANSMITTER GOES TO GAOL.
George W. Fellowes, an Englishman, has been sentenced to a year's imprisonment at Leavenworth, Kansas, for operating an unlicensed wireless transmitter. On completion of the sentence he is to be deported as "an undesirable alien."

HIGH JINKS ON THE BROADCAST BAND.
The countryside within a radius of 38 miles of Lyons formed the arena for a hidden transmitter hunt on Friday last, May 16th, when wireless enthusiasts, both amateur and professional, competed for a number of prizes offered by a firm of valve manufacturers. The competitors scoured the country in cars fitted with directional receivers. That the concealed transmitter operated on the broadcast wavelength of 350 metres is an indication of the laxity of the French wireless laws.

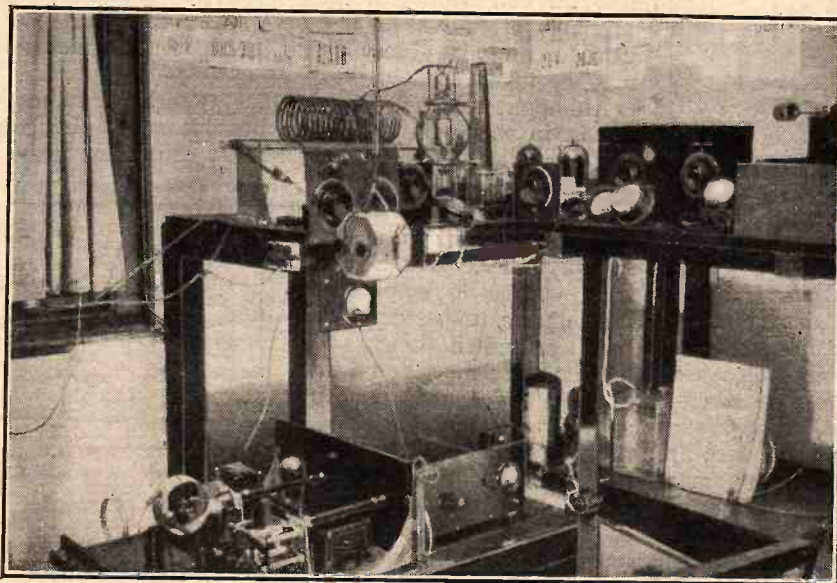

A SCOTTISH TRANSMITTER. G 6RG, owned and operated by Mr. B. Groom at 157, Wood Street, Galashiels. In the foreground is seen the 2-valve short-wave receiver with Marconi Reisz microphone suspended above it. The crystal-controlled transmitter is conveniently arranged on the two benches.

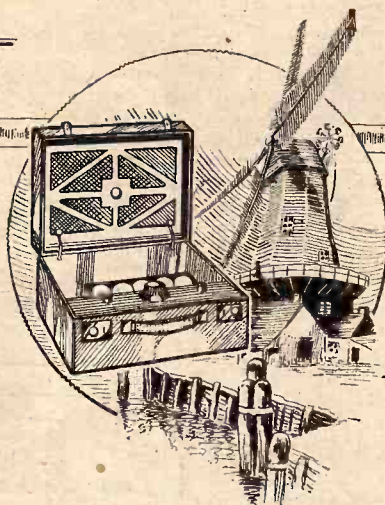
Events of the Week
in Brief Review.

FINLANDIA.
Licensed listeners in Finland now number 90,232, of whom 12,984 are of Swedish nationality.

TWIN SHORT WAVES IN CZECHOSLOVAKIA.
We learn that the new short-wave station at Podebrady will comprise twin transmitters working on wavelengths between 15 and 20 metres.

FAREWELL, I.B.C.
Now that the Indian Government has taken over the broadcasting organisation the Indian Broadcasting Company has ceased to exist. The official designation is now "The Indian State Broadcasting Service." The headquarters are at Radio House, Apollo Bunder, Bombay.

THE TEN-POUND WIRELESS SET.
An interesting item in the competition list of the Royal Welsh National Eisteddfod, to be held at Llanelly from August 4th to 9th, is the following:—
No. 339. The Best Wireless Set, costing not more than £10. Reception, workmanship and value for money to be taken into consideration. Prize £3. Given by O. S. Neill, Esq.

WIRELESS AND PHYSICAL RESEARCH.
Dr. W. H. Eccles, F.R.S., will deliver the Presidential Address of the Institute of Physics at 5.30 p.m. on Tuesday next, May 27th, at the Institution of Electrical Engineers, Savoy Place, W.C.2. The title of the address will be "The Influence of Physical Research on the Development of Wireless." The meeting is open to the public without ticket.

INTERNATIONAL WIRELESS CONFERENCE.
The Fourth International Conference on Wireless Regulations is to be held at Liège from September 22nd to 26th next, the delegates being the guests of the Belgian Government. The meetings will be held in the University buildings, and will be officially opened by M. Forthomme, Belgian Minister of Posts and Telegraphs.

SCHOOL WIRELESS SHOW.
Wireless receivers specially suitable for use in schools are being shown this month at the Palais du Cinquantenaire, Brussels, under the auspices of an association recently formed to extend the use of wireless in educational work. A feature of the exhibition is a competition for schoolmasters, who are asked to devise plans for obtaining the best results with school wireless.

"ELETTRA" TALK RELAYED.
An unrehearsed conversation between Senator Marconi's yacht *Elettra* in the Mediterranean and the studio of the American National Broadcasting Company in New York was recently relayed over the entire network of American broadcasting stations. Senator Marconi used a transmitting power of 750 watts on a wavelength of 26.7 metres, while the transmission from America, via the Schenectady station, was conducted on 19.5 metres.

COMMERCIAL RADIO-TELEPHONY PIONEER.
Mr. F. S. Mockford, in charge of the Croydon Air Port Wireless Station for nearly eleven years, and the examiner for aircraft wireless operators' licences, has resigned to take up an appointment with Marconi's Wireless Telegraph Co., Ltd.
The station at Croydon has been in continuous operation since 1919, and is believed to have been the first in the world to open a regular commercial radio-telephone service.

SHETLAND STILL CALLING.

Portable wireless came to Shetland's rescue last week after the breakdown of the cable between Lerwick and the Scottish mainland. The apparatus was taken by steamer from Aberdeen and erected at the dismantled wireless station near Lerwick.

○○○○

OFFICIAL PRAISE FOR FRENCH AMATEURS.

While conducting a tour of the French military wireless stations in Morocco last week, General Ferrié picked up a message from a French amateur on 45 metres. The General replied with a message of goodwill to all the amateurs of France, and expressed his admiration of their work on the short-wave band.

○○○○

ANOTHER TWIN-WAVE STATION.

Dual transmission stations show promise of being the rule rather than the exception in the next few years. The latest twin transmission scheme is that of Hungary. According to present plans Budapest is to have a 120 kW. station sending two programmes simultaneously, the object being to provide a satisfactory service to crystal listeners in all parts of the country.

○○○○

WAVELENGTH CHAOS IN RUSSIA.

Three new 100-kilowatt broadcasting stations are to be erected in Soviet Russia, according to the Russian journal *Electrosvyas*, which also gives details of the growing amount of interference throughout the country. The worst conditions prevail in Moscow, thousands of complaints from listeners in this area having been addressed to the Russian Station Commissariat.

Having rejected the Prague Plan, Russia can expect little sympathy from the rest of Europe.

○○○○

I.E.E. WIRELESS SECTION.

The following have been nominated by the Wireless Section Committee to serve on the committee from October 1st, 1930:—Chairman, C. E. Rickard, O.B.E.; ordinary members, G. W. N. Cobbold, B.Sc., B. E. G. Mittell, E. H. Shaughnessy, O.B.E., G. Shearing, B.Sc., L. B. Turner, M.A. The following will continue to serve as members of the committee:—The President, I.E.E., the Chairman of the Papers Committee, I.E.E., a nominee of the Council, I.E.E., a nominee of the General Purposes Committee, I.E.E., R. H. Barfield, M.Sc., A. J. Gill, B.Sc., Professor E. Mallett, D.Sc., E. B. Moullin, M.A., L. C. Pocock, Commander J. A. Slee, C.B.E., R.N., P. K. Turner, together with one representative each to be nominated by the Admiralty, the Air Ministry, the General Post Office, and the War Office.

○○○○

TROUBLE IN AUSTRALIA.

An ominous decrease in the number of wireless licences is being made the basis of a severe attack on the recently formed Australian Broadcasting Company and the Government Department concerned. In accordance with a Royal Commission set up in 1927, the Government undertook to maintain the transmitters and to erect relay stations in suitable centres, at the

B 17

same time inviting tenders for the provision of programmes.

According to our Australian contemporary, *Wireless Weekly*, the Government has not fulfilled its promises. "Transmission is worse," says the journal. "There are no relay stations, and, as a result no new listening areas. The Australian Broadcasting Company finds its revenue too small to provide the first-rate programmes it proposed."

Australian listeners pay an annual licence fee of 24s., this amount being allotted as follows:—12s. for the pro-

gramme, 3s. to the holders of patent rights, and 9s. to the Government. Listeners are now asking if the Government's attitude justifies such a large proportion.

WIRELESS AT WESTMINSTER.

(From Our Parliamentary Correspondent.)

No Revision of B.B.C. Charter.

In the House of Commons last week Major Glyn asked the Prime Minister whether he would enquire into the charter of the British Broadcasting Corporation with a view to its revision so as to make the Postmaster-General responsible for questions such as the treatment and remuneration of the officials of the corporation, and also to enable the programmes to be subjected to effective criticism both concerning their quality and the sums paid in some instances for the rights of reproduction.

Mr. MacDonald said he did not consider that it would be advisable to revise the charter of the British Broadcasting Corporation in the sense indicated by Major Glyn.

○○○○

Licence Revenue.

Mr. Viant, the Assistant Postmaster-General, stated that the gross revenue received from wireless licences during the twelve months ended April 30th, 1930, was about £1,550,000. The corresponding figure for the previous year was about £1,370,000, and for 1924 about £500,000.

TRANSMITTERS' NOTES.**Amateur Convention in Germany.**

The Fifth Convention of German amateurs will be held at Halle, Saale, from June 7th to 9th. The programme arranged is:—

Saturday, June 7th. 8 p.m., Greetings.
Sunday, June 8th. Morning, Business Meeting.
Monday, June 9th. Lectures by Dr. Wigge (D4AFF) and Mr. Wigand (D4CX).

There will also be station visits in Halle. All British amateurs will be heartily welcomed, and those wishing to attend this convention should communicate before June 3rd with the Hon. Secretary, D.A.S.D., Blumenstrasse 19, Berlin, W.57, or with Mr. M. W. Pilpel, 54, Purley Avenue, London, N.W.2.

NEW CALL-SIGNS.

- G5CL M. Shaw, 24, Asbroft Drive, King's Park, Glasgow (Change of address). Transmits on 20 and 40 metres and will welcome reports.
- G6BT C. A. Jamblin, 121, Queen's Road, Bury St. Edmund's, Suffolk. (Change of address.)
- G6RH R. Holmes, 5, Mostyn Avenue, Allerton, Liverpool. Transmits on 20 and 40 metres C.W. and telephony.
- 2BJR G. A. Swinerton, 109, Shireland Road, Smethwick, Birmingham.
- ON4JF G. Cordier, 124, rue St. Laurent, Liège. Belgium.
- France.**
- F8BT R. Chevailler, 41, rue du Rocher, Bordeaux.
- F8BX P. Germond, 46, Bld. du Chateaudun, Orleans, Loiret.
- F8EY R. Gay, 15 bis, Avenue Edouard VII, Dinard, Ile-et-Vilaine.
- F8IQ H. Bosquet, 4, rue Parbes Penas, Herault.
- F8KF M. Clemens, rue Lakanal, Lunel, Herault.
- F8KW M. Lagrue, 4, Avenue Marie Alexandrine, Colombes Seine.

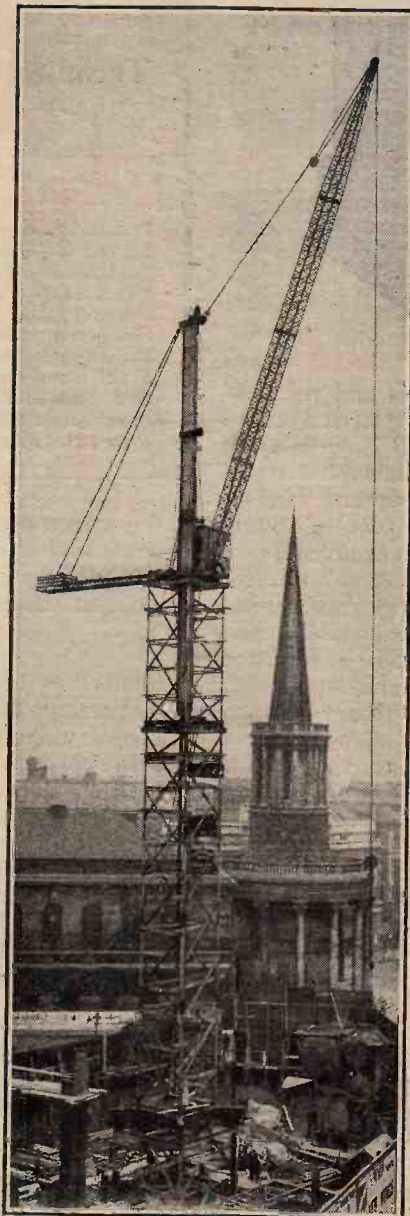

BROADCASTING HOUSE. A striking photograph taken last week showing the preparations in hand for the erection of the steel framework of the new B.B.C. headquarters in Portland Place. A portion of the Queen's Hall can be seen behind the Church of All Souls, Langham Place.

Broadcast Receivers Reviewed



FERRANTI

A.C. MAINS SET

Technical Description and Results of Test.

SPECIFICATION.

Transformer-coupled S.G. stage. Osram M.S.A.
Leaky-grid detector. Osram M.H.L.A.
Transformer-coupled L.F. stage. Osram P.625.
Two wave ranges.
Two-dial tuning.
Grid bias by cathode resistance and half-wave metal rectifier.
Volume control by variable aerial condenser.
Reaction control by revolving coil.
Section-wound tuning coils on bakelite formers.
Power output 880 milliwatts (6 watts anode dissipation).
Price £25. Royalty £1 extra.

SCIENTIFIC design on original lines and the publication of performance data have placed Ferranti products in a foremost position. It is, in fact, an established practice to use an L.F. intervalve transformer bearing the name "Ferranti" in any receiver that bids for quality reception. We proceed, therefore, with more than usual interest in an examination of the Three-valve All-mains set, the first Ferranti receiver to appear on the market. Almost every reader must be anxious to glean precise details of the general design and performance of this receiver, which is regarded as one of the best British productions. This report will, therefore, take the form of facts rather than comment, bearing in mind that unqualified observations shorn of other considerations do not always convey a fair criticism.

Circuit.

Apart from the mains equipment, the circuit represents a standard arrangement of an indirectly heated S.G. valve with aerial and intervalve H.F. transformers. Detection is by leaky-grid condenser with values of 0.0003 mfd. and 1 megohm. In order to provide a maximum grid swing to the output valve, the new high-ratio A.F.6 intervalve transformer is used representing a departure originating in the Ferranti laboratories. Grid bias for the output valve is obtained from a half-wave metal rectifier. A transformer matches the output valve to either a high- or low-resistance loud-speaker winding, and provides complete separation from the high-tension supply.

Full-wave valve rectification is used, and smoothing is by a single choke in the positive lead and the usual condensers. Voltage regulation is obtained by a bank of resistances giving potentials of 130, 72, and 240 volts to the anodes of the three valves in succession

and a screen potential of 68 volts. A resistance in the cathode lead of the H.F. valve gives a negative bias of 1 volt, while a metal rectifier applies a 28-volt bias to the output valve.

Construction.

Stout tinned-iron plate is used in the construction of a housing, the pieces being held together by rivets and spot welding giving considerable strength. Ribbed bakelite formers support the coil windings, which are carried in slots. Geared drives are fitted to the all-brass tuning condensers, and small lamps give indirect lighting to the scales. An entirely novel feature is the use of flexible drives between the reaction and volume controls and the condenser and swinging coil with which they are associated. A four-pole switch secured to the metal barrier separating the aerial and H.F. tuned circuits changes the wave range by short-circuiting sections of the windings. All voltage-regulating resistances are of the moulded type, and operate with an inappreciable temperature rise. With the apparatus assembled and wired as a complete unit, it is slid into the back of a tall rectangular cabinet of elegant design.

On Test.

Reception requirements vary with locality, but it is reasonable to take London as a place of test, where a radius of fifty miles embraces one-third of the listeners of the British Isles, while to demonstrate selectivity the test was carried out at a distance of five miles from Brookmans Park. An aerial consisting of 60ft. of

Broadcast Receivers Reviewed—Ferranti A.C. Mains Set.—wire was used, sloping up from the ground at an angle somewhat steeper than 45 degrees. As was perhaps to be expected, either of the two London stations was received at full loudspeaker strength, irrespective of the setting of the H.F. tuning dial, though the aerial tuning condenser gave almost complete separation.

It was to be noted that control of volume was provided by a small variable condenser in the aerial lead. With this condenser set to zero, the London Regional could be cut out within five divisions on either side of 40 on the 100-division aerial condenser scale, while the National programme came in at good strength up to 30 divisions from zero. At 60 divisions the Midland Regional could be tuned in at full strength by slightly advancing the volume control off zero, and in this position reception was clear of the two Londons. These tests were made with the "range" control at zero, and in this position the reaction coupling is completely reversed from the position of regeneration. Although a slight mains hum could be produced with certain settings of the dials, reception was always possible with absolute freedom from mains or background noises.

Rejector Units.

In the position of minimum reaction coupling, but with the volume control at maximum, a few foreign stations were tuned in after dark, but to the accompaniment of the Brookmans Park transmitters. To overcome these difficulties arising from local station interference, a wave rejector has been produced which

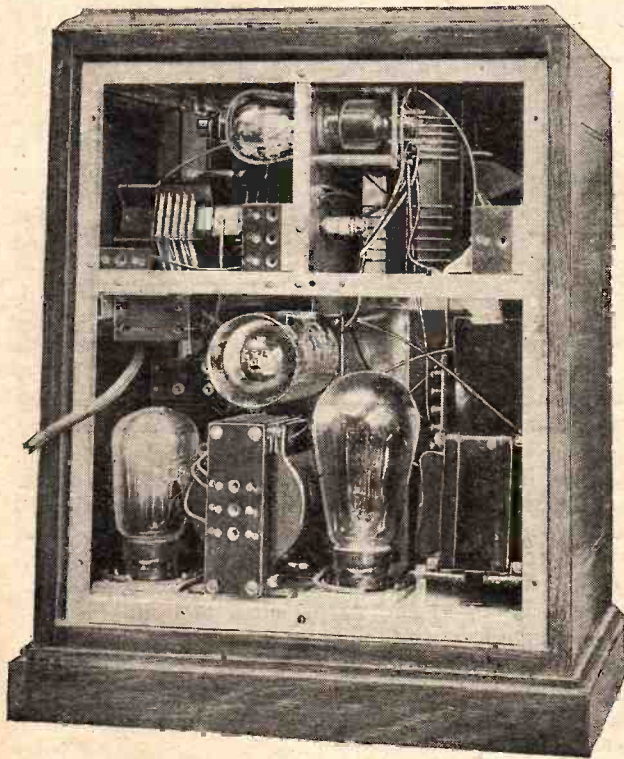

On removing the back panel the mains leads become disconnected. An electrostatic screening tube surrounds the horizontal detector valve.

B 19

forms a sub-base to the receiver. Its four controls consist of a three-position switch and three condensers of small capacity. Interposed in the aerial lead, this unit consists of three tuned rejectors closely adjusted to the wavelengths of 261, 356, and 1,554 metres. The vari-

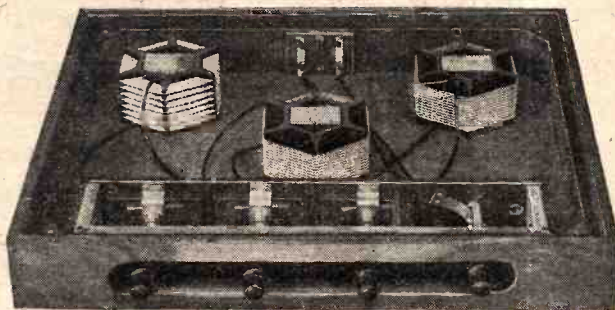

Ferranti rejector unit for removing local interference. It forms a sub-base to the receiver.

able condensers provide critical tuning for these circuits, and a three-position switch gives a straight-through connection from aerial to set, or introduces simultaneously the pair of short-wave circuits or steps over to the long wave. These rejectors permit of foreign station reception, and provide complete removal of the local interfering signals, but over a much sharper wave band than that on which the signals are to be found. Slight adjustment of the rejectors sufficiently shifts their tuning to remedy this difficulty. Locating pins projecting from the top face of the filter unit could be usefully added in order to hold the receiver in position.

Distant Reception.

Foreign station reception on the broadcast band during darkness gave, under the average conditions of test, some half-dozen stations with a clarity and entire freedom from mains noise that rendered listening to the transmissions worth while. For this result the rejector unit is a necessity. On the long wave band Radio Paris could be received in daylight, and after dark the customary four transmissions could be tuned in. Here again the rejector is a necessity for the removal of 5XX, and adjustment of the rejector is called for during reception.

Although it will not fall to the lot of the average listener to operate the dials continuously for several hours, as was necessary during this test, attention may be drawn to the difficulty in manipulating the tuning controls, which results from the knobs being located so high above table level.

A three-pin connector at the back of the set allows for the introduction of a gramophone pick-up. When the connector is inserted, the voltage from the pick-up is fed into the grid of the detector, the necessary negative bias being obtained by the voltage drop across a resistance in the cathode circuit.

Selling at £26, including valves and patent royalty, this receiver will give prolonged service without needing attention.

HIGH PERMEABILITY ALLOYS

Their Application to Intervalve Transformers and L.F. Chokes.

(Contributed by the Research Staff of R.I. Ltd.)

UNTIL about the year 1920 the best material available for the manufacture of commercial power transformers, audio-frequency intervalve transformers and L.F. choking coils, consisted of a 4 per cent. silicon steel, rolled and cut into laminations of suitable thickness and size. Large power transformers have been made for many years, having cores of this material, whose electrical efficiencies have been made as high as 98 per cent., or even more.

It was natural, therefore, that with such a material available an application was immediately found for its commercial use in the smaller types of transformers (mainly intervalve L.F. types) required in the earlier days of the radio industry; a large number of such transformers have been made, and are now in use in probably millions of radio receivers and amplifiers. It was soon realised, however, that, although these transformers had very good qualities and characteristics, they could be much improved in their particular characteristics, and their bulk and weight could be considerably reduced at the same time if magnetic cores were available having considerably higher values of effective permeability.

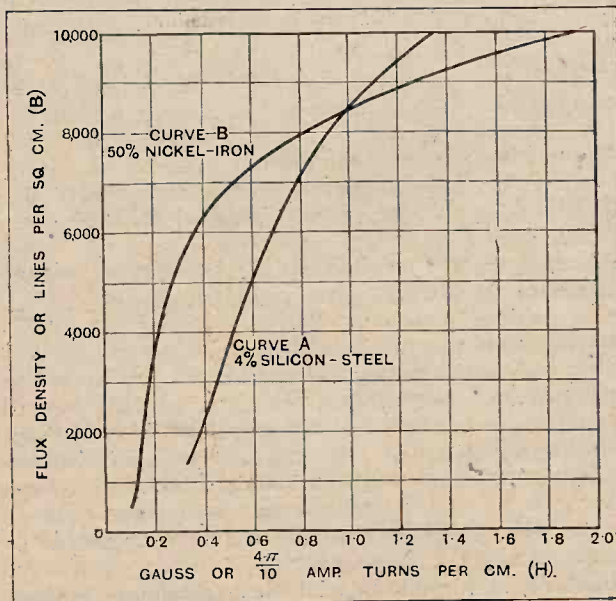

Fig. 1.—Curves showing relative flux densities for 4% silicon steel and 50% nickel iron.

Early investigators, such as Barrett, Brown, and Hadfield, were aware of the possibilities attached to alloys of nickel and iron, and in 1910 Panebianco showed that such alloys were of magnetic importance. In 1920 T. D. Yensen read a paper before the American Institute of Electrical Engineers, giving more detailed information, and showing the importance of alloys having about 50 per cent. nickel and 50 per cent. iron.

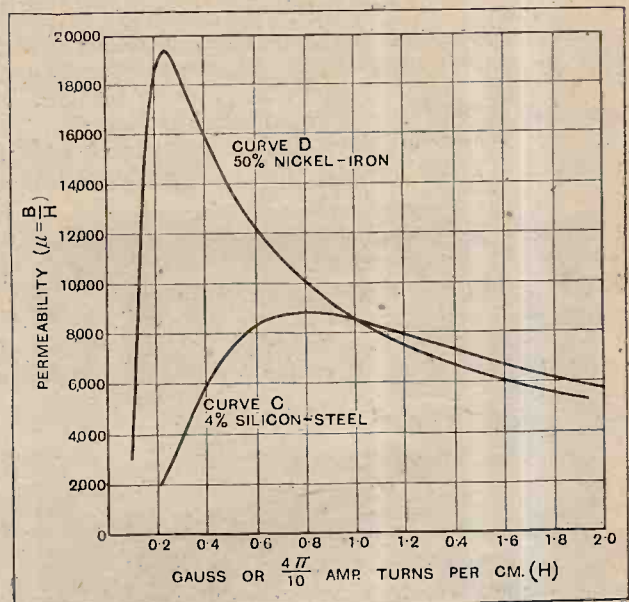

Fig. 2.—Showing permeability of the same alloys as described under Fig. 1.

In the light of still more recent research, it is found that the most useful nickel-iron alloys may be divided into two well-defined groups: the one group, after Yensen, containing approximately 50 per cent. of nickel and 50 per cent. of iron, and the other group about 78 per cent. of nickel and 22 per cent. of iron.

The magnetic permeability of these alloys varies from about twice to about six or seven times that of the best silicon-steel materials, and it would appear to lead the way to their use for choke and intervalve transformers for radio purposes.

Fig. 1 shows common B/H curves, and Fig. 2 shows μ/H curves for 4 per cent. silicon steel and 50 per cent. nickel iron. Incremental permeability curves are

High Permeability Alloys.—

also given in Fig. 3, which figures are effective where the cores carry D.C. magnetising forces as shown.

The advent of these magnetic alloys did not, however, produce such a great revolution in all transformer design, due to the electrical limiting features which here follow; but it did produce a marked interest in the magnetic cores which can be used by modern designers for power transformers of all sizes and for L.F. intervalve transformers and choking coils as used in modern radio receivers. The R.M.S. value of E.M.F. which is induced into a secondary winding of any transformer may be obtained from the fundamental equation:—

$$E = 4.44\phi f T \times 10^{-8} \text{ volts,}$$

$$\text{or } E = 4.44BAfT \times 10^{-8} \text{ volts.}$$

Where B = flux density in lines per sq. cm.

ϕ = total flux.

A = area of flux path in sq. cms.

f = frequency of alternation in p.p.s.

T = secondary turns.

Similarly, this formula will give the primary back E.M.F. (which is equal in magnitude to the forward E.M.F. or applied voltage) if T is the number of primary turns. From this equation, the primary turns

$$T = \frac{10^8 E}{4.44 BAf},$$

showing that for equal applied primary voltages, equal frequencies and equal core areas, the number of requisite primary turns T are inversely proportional to the working flux density B. Thus, any proposed new core material to replace 4 per cent. silicon steel for mains power transformer purposes must have an economical working flux density equal or greater than that for silicon steel.

Unfortunately, as illustrated in Fig. 1, the new high permeability magnetic alloys have economical working flux densities much less than that of silicon steel, and consequently there are greater primary turns required for the use of these alloys on mains voltages and mains frequencies. This does not mean that high permeability alloys cannot be used at all for the making of mains power transformers, but that excessive turns must be used if an attempt is made to do so. The result is a very inefficient transformer, due to the use of far too much copper, producing excessive copper power loss.

Now L.F. intervalve transformers are not required to deliver any appreciable power, but to give in most cases just a step-up of voltage from primary to secondary. So that actual power efficiency here does

not have to be considered. Therefore, there is an immediate application for high permeability alloys in the manufacture of L.F. intervalve transformers. The extremely satisfactory performances obtained from L.F. intervalve transformers with high permeability alloy cores are thus only rendered possible by reason of the fact that they operate on "no load." The high permeability feature is of great importance, since high primary inductance is required. The inductance of the primary is given by the formula $L = \frac{1.257T^2\mu A \times 10^{-8}}{l}$

henrys for a theoretically closed magnetic core where μ = the effective permeability.

l = mean flux path length in cms.

A = flux path area in sq. cms.

For a given value of primary inductance, it will be noticed that an increase in core permeability may be accompanied by a decrease of primary turns.

In order that an intervalve transformer shall give uniform amplification throughout the whole of the range of audio frequencies, it is absolutely essential that the minimum turns shall be used so as to decrease the self-

capacity of the windings (particularly the secondary) and to decrease flux leakage. It is also desirable to reduce the general dimensions to the lowest practicable figures. Where the core carries D.C. anode current, the effective primary inductance is given by the formula $L = \frac{1.257T^2A\mu \times 10^{-8}}{l}$ henrys, where " μ " is the core incremental permeability.

As shown later in the notes on L.F. chokes, it is possible to obtain maximum effective inductance by a suitable choice of air-gap length to be inserted in the flux path and the inductance formula then becomes

$$L = \frac{1.257T^2A \times 10^{-8}}{l/\mu_1 + a}$$

henrys where "a" is the air gap length in cms. But in such cases the number of primary turns has still to be of a fairly high order, and a greater weight of alloy needs to be used for the production of high inductance with low turns. Fig. 4 gives voltage amplification curves for both silicon steel and nickel-iron cored transformers, whose total weights are shown. These curves indicate the superiority in overall performance of the nickel-iron core, more particularly where the transformer is connected with the parallel-feed system. The reduction in total weight given by the use of the 50 per cent. nickel-iron alloy is of considerable im-

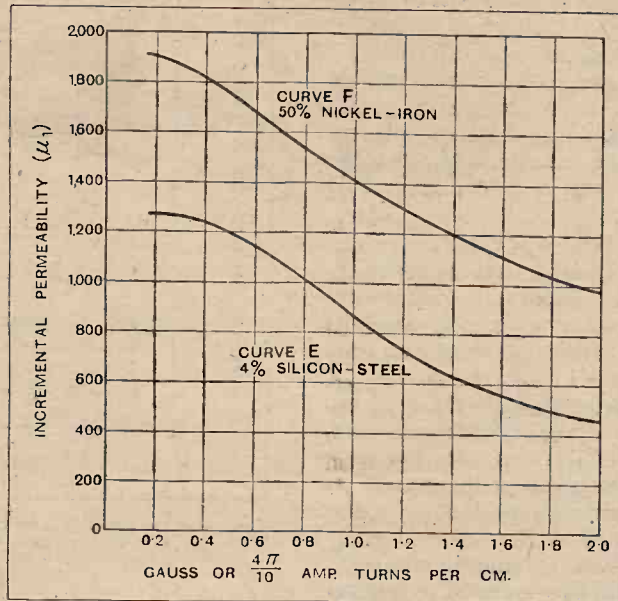

Fig. 3.—Incremental permeability curves.

High Permeability Alloys.—

importance in some radio receivers where considerations of total weight and bulk must be studied. It would be well to comment here upon the reason for the perfection of very low note amplification with the parallel-fed system; it is due to voltage resonance of the transformer primary and coupling capacity, and *not*, as is often conjectured, to an exceedingly high primary inductance obtained with absence of D.C. anode current through the primary. The transformer giving response curve "G" has a primary inductance of 85 henrys.

In the design of L.F. choking coils we have practically only to study the details of effective inductance and D.C. resistance as regards electrical features; a glance at Fig. 5 will show that effective inductances of equal high order and equal D.C. resistance are obtainable by the use of 50 per cent. nickel iron in place of silicon steel cores and give the considerable advantage of about one-half the weight and a reduction in bulk.

Fall of Inductance when Carrying D.C.

The last formula quoted is equally true for giving the effective inductance of an L.F. choke coil. High incremental permeability of the core is absolutely essential, and a correct proportioning of air-gap length to mean flux path length must be used to give a suitable rate of change of effective inductance with D.C. current passing. Choking coils may be made which give substantially constant effective inductances over the whole of their useful D.C. current ranges, but this means the employment of an effective air gap much greater than otherwise necessary. A glance at the last inductance formula shows that, for a given volume of core, such an effect may only be produced by the use of excessively high turns and a resultant high D.C. resistance.

In order that a choke coil should have the greatest application for the many uses to which it may be put in radio receivers and L.F. amplifiers, it should be capable of maintaining about half or two-thirds of its highest

effective inductance at its highest D.C. current load; at this highest load it should not give an excessive D.C. "voltage drop" and its temperature rise should be normal.

Once the design details have been obtained of such chokes giving similar curves to those shown in Fig. 5, the figures for any one choke may be advantageously

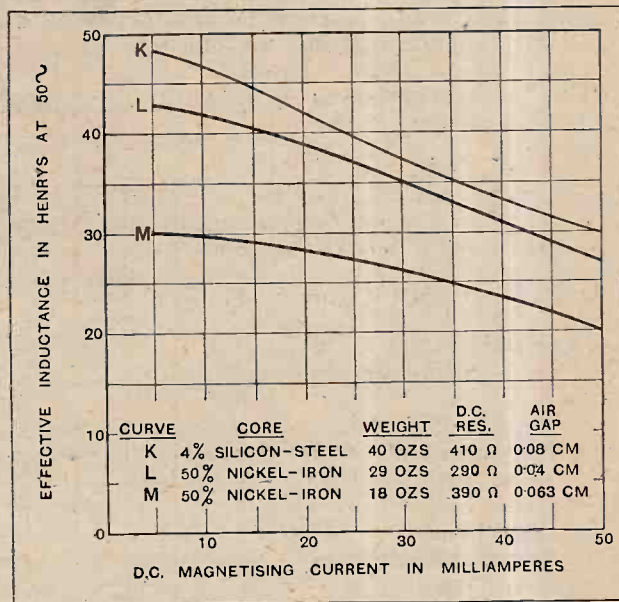

Fig. 5.—The effective inductance of chokes with cores of various alloys. The curves show that with a small air gap only a relatively small drop in inductance takes place with maximum D.C. load.

used for designing other chokes, either on similar or different cores. For instance, taking curve M, if the turns are T, a curve may be plotted showing effective inductance against ampere turns. Using an exactly similar

core and new turns T₂, its exact curve for inductance against D.C. current may be predetermined by a calculation of a few points giving the products of $\left(\frac{T_2}{T_1}\right)^2$ and the effective inductances shown by curve M for equal values of ampere turns for the two chokes. By way of example, if choke M has 5,000 turns and gives 20 henrys at 50 mA., the effective ampere turns are 250. Then a choke of 4,000 turns passing a D.C. current of $\frac{250}{4000} = 62.5$ mA. will give an effective inductance of $20 \times \left(\frac{4000}{5000}\right)^2$ at the current of 62.5 mA.

The calculation is based upon the fact that the effective incremental permeability depends directly upon D.C. magnetising ampere turns and flux density produced, and is constant for any one core plus gap and one

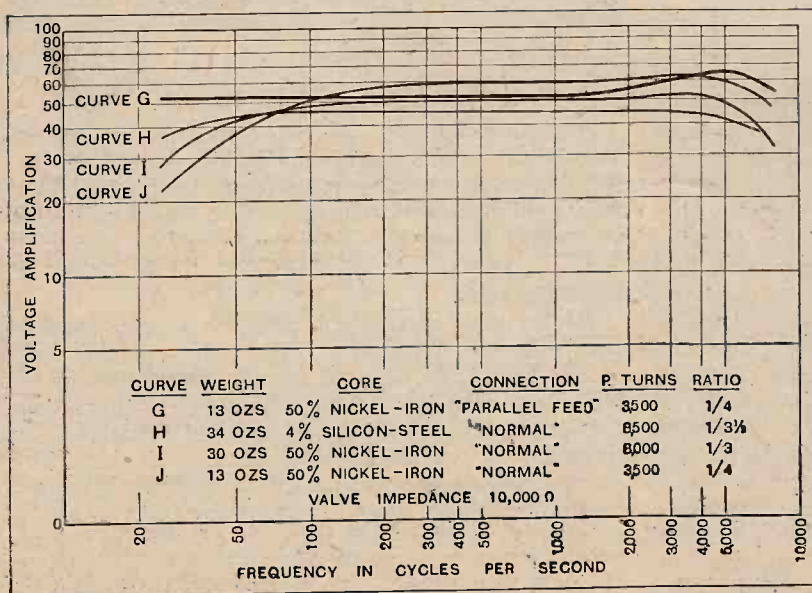

Fig. 4.—Voltage amplification for silicon steel and nickel iron-cored transformers.

High Permeability Alloys.—

value of ampere turns. From the designs and dimensions of one choke, it is also possible to predetermine accurately the dimensions and all data for a range of choking coils, all of which have the same inductances at minimum current, at maximum current, and at fractional intermediate values; they will naturally have different values of maximum D.C. current, also different D.C. resistances. Since, for any given core and gap, the flux density produced is proportional to ampere turns and inversely proportional to $\left(\frac{l}{\mu} + a\right)$, if

the ampere turns, the length of flux path, and the gap length are all multiplied by the same mathematical constant, the flux density will remain as before. Hence the incremental permeability will not be altered. Also, since effective inductance is proportional to area and inversely proportional to $\left(\frac{l}{\mu_1} + a\right)$, the inductance will remain as before, provided the core area is multiplied by this same constant and that the turns are not altered.

By way of example, if curve M is obtained with turns, $T=5000$,

Core area $A=1.7$ sq. cms.,

Flux path $l=1.6$ cms.,

And air gap $a=0.063$ cms.,

then taking a modification constant of 1.3, the new turns, $T=6500$.

Core area $A=2.2$ sq. cms.,

Flux path $l=20.8$ cms.,

And air gap $a=0.082$ cms.

Since curve M shows an effective inductance of 20 henrys at 50 mA., the new choke will give an effective inductance of 20 henrys at $1.3 \times 50 = 65$ mA. Curve M also shows 30 henrys at 5 mA.; the new choke will then give 30 henrys at $1.3 \times 5 = 6.5$ mA. The D.C. resistance of the new choke may be readily calculated from the new modified available winding area.

In the manufacture of any of the nickel-iron alloys it is absolutely necessary to exclude practically all traces of impurities. The nickel-iron curves shown in Figs. 1, 2 and 3 are for a material containing approximately 50 per cent. of nickel and iron; this particular alloy is very pure, and contains only minute traces of other elements. Impure magnetic alloys produce poor magnetic characteristics, and, in addition, are magnetically unstable. A test on a set of laminations taken after cold rolling and punching reveals the fact that, magnetically, the material is quite useless in this state and develops a permeability of about only one-tenth of the value obtained after the special heat treatment to which they are later subjected. This process is an exceedingly important operation and is necessarily carried out under skilled technical supervision. After emerging from this process, it is essential that the stampings shall be treated carefully and not hammered or bent, as this destroys to some extent the magnetic properties. It is not within the scope of these notes to deal with any other of the very high permeability alloys, some of which may be made to give permeability figures as high as 60,000 and have other applications.

No mention has been made here of the core energy losses associated with this particular alloy used for the intervalve transformers and chokes dealt with. Core losses are of little importance here, since the intervalve transformers have high winding resistances, and power or energy efficiency need not be studied; the choking coils may have reasonably high core losses and still give the high effective inductances quoted.

In compiling this article, the writers are greatly indebted to Mr. J. A. Holden, of Magnetic and Electrical Alloys, Ltd., for notes and curves appertaining to the nickel-iron alloy. It is hoped that all technical data here given will be of interest to those many radio enthusiasts who not only take great pains in their choice of components, but often have considerable technical knowledge of the electrical and other features desirable.

The Legitimate Use of Reaction.

THERE are those who say that no receiver can possibly give its fullest efficiency unless reaction is used. There are others who maintain that it should be made a criminal offence to fit a reaction control to any set. Both views are extreme, but both contain a germ of truth.

Reaction is usually associated with the use of a grid rectifier, where the grid current damps the tuned circuit to a very considerable extent. The effect of this damping, and of any other damping due to such causes as dielectric losses, can be nullified by the intelligent use of reaction. In a receiver of this kind there is therefore a certain setting of the reaction control that invests the tuned circuit with the same resistance that it would have had if dielectric losses had been carefully minimised and an anode detector, which is free from grid-current damping, had been used. If reaction is pressed no farther than this, its use can hardly be regarded as

criminal, for the tuned circuit has exactly the same resultant resistance as in many receivers in which reaction is not used at all. The use of reaction up to this point may therefore be regarded as perfectly legitimate.

There is, however, the temptation to increase reaction beyond this point in an endeavour to improve the sensitivity and selectivity of the receiver. Apart from the fact that this increase is liable to result in oscillation, to the infuriation of every listener for miles round, the user of the set himself begins to suffer. Signals received when the set is on the verge of oscillation are always distressingly poor in quality, for the resultant resistance of the tuned circuit has been so reduced that the outer side-bands are not received at all. All high notes are therefore completely missing, music becomes just a noise, and speech is nearly unintelligible through lack of consonants. Such results indicate that reaction is being used to an illegitimate extent. A. L. M. S.

CORRESPONDENCE.

The Editor does not hold himself responsible for the opinions of his correspondents.

Correspondence should be addressed to the Editor, "The Wireless World," Dorset House, Tudor Street, E.C.4, and must be accompanied by the writer's name and address.

SHORT WAVES.

Sir,—I forward the following report on reception obtained with *The Wireless World* S.G. Short Wave III (slightly modified). I hope this report will be of interest to you and to readers of *The Wireless World*.

On April 5th at 1945 G.M.T. I picked up 2XAD on 15,340 kc., and had no difficulty in tuning him to loud speaker strength. The reception was very interesting, because I found that 2XAD was making special tests with Senator Marconi, who was aboard his famous yacht, the "Elettra," which was at the time lying in Genoa harbour. Speech was so clearly received that the "Elettra's" replies could be heard being retransmitted by 2XAD (not being relayed intentionally). Direct transmissions from the "Elettra" on 11,255 kc. were also picked up quite clearly during the above test. On the same receiver G5SW, PCJ, and Zeoson are received at excellent strength whenever desired.

J. M. DRUDGE-COATES,
Somaliland Boundary Commission.

EMPIRE BROADCASTING.

Sir,—5SW is useless to those who pay for licences; in fact, the majority cannot hear 5SW!

The completion of the regional scheme and the improvement of 5XX is held up mainly for financial reasons.

Already the B.B.C. finances have more than one parasite attached; why add another. No doubt those who would benefit by expenditure on the lines of 5SW would be willing to pay; therefore, it appears that the first thing to do is to evolve some scheme by which the short-wave station is financed independently. All other difficulties would quickly disappear.

Margate.

ARTHUR HOBDAV.

[We agree that the station might divert the financial resources of the B.B.C. from other objects, but it must be remembered that the B.B.C. originally shouldered the burden.—Ed.]

THE MARCONIPHONE PICK-UP.

Sir,—In your pick-up tests reported in the issue of *The Wireless World* of April 2nd (page 358) it is stated that the Marconiphone pick-up "adequately compensates for the restriction in amplitude of the lowest frequencies recorded."

From the makers' test curve I find that at 50 cycles the pick-up is 4 T.U. above its level at 250. This is undetectable by ear, and is quite inadequate to compensate for the loss in recording which is actually 14 T.U.

I designed a corrector to fit the Marconiphone pick-up. The quality obtained with the aid of this compensator is, in my opinion, a great improvement on that obtained with the pick-up alone.

N. W. McLACHLAN.

BRITISH MANUFACTURERS.

Sir,—I have a grouse against British manufacturers of condenser dials. My trouble is that (1) I have not yet come across a British-made dial with a gear ratio of more than 30 to 1; and (2) that very few manufacturers state the gear ratio in their catalogues or advertisements.

For short-wave work the gear ratio of condenser dials is of the greatest importance and is a point that makes itself very much felt in the operation of a short-wave receiver.

I would point out that there are, at least, two excellent dials manufactured in the United States. One has a ratio of 80 to 1, the other 63 to 1. But we do not want American dials—we want our sets to be 100 per cent. British.

I could mention many other components made in the U.S.A.—in particular wirewound, tapped transmitting gridleaks in respect of which I envy American "Hams." Of course, I

realise there may be such components made at Home, but if they are, why are they not advertised?

I am sure that short-wave enthusiasts of the "Buy British" ilk will appreciate publicity being given to the above in your columns.

GEO. D. FORBES.

Batu Gajah, F.M.S.

THE REGIONAL SCHEME.

Sir,—Now that this scheme has got well into its swing it seems appropriate to draw attention to its very serious limitations, at least from the point of view of the writer, and he believes of many other people.

The apparent aim of the B.B.C. is to supply the whole country with one programme, or at the very most two; last Sunday evening being a typical example, when every station in the country broadcast the same programme.

As compared with the service of a few years ago this seems a very retrograde step.

Further, the power of these new stations is so great that it would appear to be the intention of the B.B.C. that everyone shall be in a position to operate their moving-coil speakers from a crystal set, whilst at the same time making foreign reception out of the question to anyone who cannot afford a small fortune for a multi-stage receiver capable of cutting down the local stations adequately.

The position is, of course, not yet at its worst, but I would suggest that the ideal solution of this, probably from the B.B.C. point of view, would be to shut down all stations except 5XX which anyone can receive, although possibly this might have the unfortunate effect of giving listeners too much latitude in the way of being able to listen with ease to continental transmissions that actually have the merit of being more interesting for a greater part of the time than the majority of B.B.C. transmissions.

Finally, the B.B.C.'s idea of contrasted programmes, on the rare occasions when such are given, frequently takes the form of, on the one hand, chamber music, and, on the other, symphony concerts. Each of these forms of entertainment are acceptable, but that one should be considered as an alternative entertainment to the other is somewhat strange.

New Moston, Manchester.

J. BAGGS.

RADIO SERVICING.

Sir,—In connection with your leading article on this subject in the last issue, we would like to point out that this company has always appreciated the issues involved and has, for some time past, been giving serious consideration to the question of dealer-service.

As a result, an announcement which will be of considerable interest to the radio trade and public will shortly be made on the subject of Marconiphone after-sales service.

THE MARCONIPHONE COMPANY, LTD.

INTERFERENCE FROM LEIPZIG.

Sir,—My experience confirms that of Messrs. Craik, Bierman and Maidment.

From a rough comparison I find the interference appreciably more pronounced when using a "high-input" anode-bend detector (1-v-1 push-pull) than with an old-type (0-v-2) with grid leak detector, in spite of the fact that the former is infinitely more selective, judged by ordinary standards.

The appendix to Mr. F. M. Colebrook's article (*The Wireless World*, April 30th) appears to throw some light on this, and (by way of confirmation or otherwise) it would be interesting to know the type of circuit used by your other contributors to this correspondence.

J. V. GIL.

Esher, Surrey.

THE "DUAL" GRAMOPHONE MOTOR.

The "Dual" electric gramophone motor is made by Dual Motors, Ltd., 85, 86, New Bond Street, London, W.1, and is designed for use on all standard supply voltages of from 100 to 250. The commutator has 10 segments and the two-pole field is laminated, thereby enabling the machine to be used on A.C. as well as D.C. supply systems. A five-position switch is fitted, which should be set according to the supply voltage; an engraved plate indicates the settings for various A.C. and D.C. voltages.

The drive for the turntable spindle is transmitted through a spiral-worm drive of fibre and steel. The armature shaft carries, also, a governor of orthodox pattern which is controlled by a long adjustable arm mounted below the turntable and as a radius thereto. This is the speed control.

The screws for fixing the motor are provided with rubber buffers to prevent vibration being transmitted from the motor to the cabinet. When connected to a 200-volt D.C. supply the motor took 66 mA. running light with only a slight increase when under normal load. There are no mechanical noises apart from the faint "whirr" of the motor, and the tests we made failed to bring to light any electrical noises when used in close proximity to an amplifier.

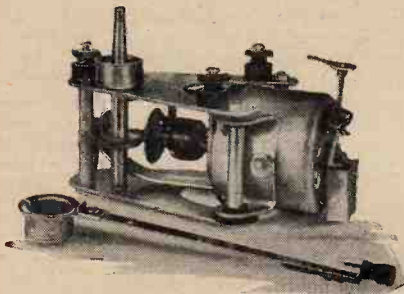

The "Dual" electric gramophone motor for use on A.C. and D.C. supply mains.

If trouble of this nature does appear, it will be due, in all probability, to oil or grease getting on to the commutator and causing sparking. Cleaning the commutator should remedy this. The equipment includes spare governor springs and a set of copper gauze brushes. The price complete, but without turntable, is £4.

o o o o

PLUG ADAPTOR.

Occasionally it is found that a battery eliminator, or charger, is required to be used in different rooms where, in some cases, a plug point offers the most convenient attachment to the mains, while elsewhere the lamp holder must be employed. To meet these varying conditions, Henry Joseph, 11, Red Lion Square, High Holborn, London, W.C.1, has placed on the market a device consisting of a lamp adaptor, into one end of which is fitted a standard two-pin plug. By attaching the flex to the plug portion the

B 25

LABORATORY TESTS on New Apparatus.

A Review of Manufacturers' Recent Products.

eliminator can be used with either type of fitting. The two elements are joined together by a short length of stout cord to prevent one part getting lost when not in use.

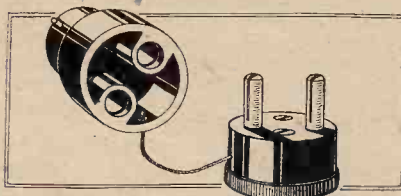

A device affording ready connection to lamp holder or plug point.

The body of the adaptor is made of bakelite, and all live parts are fully protected. Its usefulness is not restricted to wireless equipment, and it is equally suitable for attachment to any domestic electrical appliance. Distribution is being made to the trade only, but there should be no difficulty in obtaining supplies.

o o o o

LOEWE VACUUM POWER RESISTANCES.

Hitherto the vacuum type resistances made by the Loewe Radio Co., Ltd., 4, Fountayne Road, Tottenham, London, N.15, have been restricted to a type which will dissipate 0.1 of a watt. To meet the demand for a resistance suitable for use in power amplifiers, battery eliminators, etc., they have now introduced two new ranges dissipating 0.5 watt and 1 watt respectively, with resistance values of from 1,000 ohms to 1 megohm.

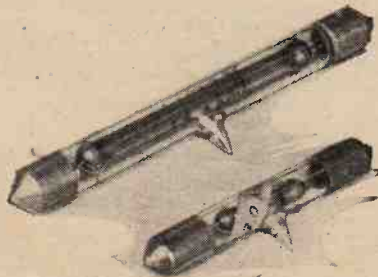

Loewe vacuum power resistance of the 1-watt type. Note the comparison in size between this and the standard pattern.

To allow for adequate cooling in view of the relatively large current carried, these new models are considerably larger than the standard pattern, and, moreover, the glass container is filled with a special gas.

The 0.5 watt type are approximately 1 1/2 in. long, and can be supplied either with plain end caps for fitting into clips, or with screw type caps, or with wire end connectors for soldering into position. The prices range from 2s. for plain caps and wire ends, to 2s. 2d. for screw cap end models.

The 1-watt resistances measure 3 in. in length, and are available with any of the three fittings mentioned above. With plain caps and wire ends the price is 2s. 3d., and with screw caps 2s. 5d.

o o o o

CLIMAX CAPITAL L.F. CHOKE.

This is a very diminutive choke, and will probably find favour where baseboard space is somewhat limited. Its overall dimensions are only 1 1/2 in. x 2 1/2 in. x 2 3/4 in. high. The magnetic circuit is a mixture of iron wires and sheet iron. The bobbin has a 7/8 in. diameter hole filled with iron wires, and the ends of these contact with the metal frame, which is bent from sheet iron. It is inevitable that air gaps will be present, but in an L.F. choke these are sometimes an advantage.

The maximum inductance of the choke is given as 40 henrys, but on measurement we found it to be somewhat lower. The



Climax Capital L.F. choke, rated to carry a maximum current of 50 milliamps.

inductance values obtained at 50 cycles when passing D.C. were as follows:—

D.C. in mA.	Inductance in henrys.	D.C. in mA.	Inductance in henrys.
0	30	30	15.75
5	24	35	15
10	21	40	14.25
15	19.3	45	13.6
20	18	50	13.2
25	16.6	—	—

The measured D.C. resistance of the winding was 630 ohms, which is 130 ohms greater than the figure given by the makers.

The price of the choke is 8s., and the makers are the Climax Radio Electric, Ltd., Haverstock Works, Parkhill Road, Hampstead, London, N.W.3.

5SW Again.

Empire listeners, particularly the Australians, will praise the B.B.C. for their decision to include the Test match reports in the transmissions from 5SW. This will involve opening the station half an hour earlier than usual on the days when the eye-witness accounts are being broadcast. The descriptions will last ten minutes, from 6.30 to 6.40 p.m.

○○○○

Empire-Day Transmission.

Contrary to its usual custom of remaining silent on Saturdays, 5SW will transit on Empire Day, May 24th, when the Hyde Park Festival, conducted by the Bishop of London, will be broadcast by the National transmitters.

The microphones should be severely tested. Besides capturing the voices of the London churches' massed choirs, they will have to cope with the massed bands of the Brigade of Guards and a programme of community singing.

○○○○

Sir Oliver Lodge's Reminiscences.

Who possesses the best "microphone manner"? Many listeners would vote in favour of Sir Oliver Lodge, who gilds the educational pill so skilfully, and can talk so clearly and intimately that no one hearing his first sentence could even dream of switching off. Sir Oliver will speak on Tuesday next, May 27th, his talk concluding the series entitled "Looking Backwards." I hope that this "G.O.M." of science will touch upon his early experiments in wireless.

○○○○

Ireland's High-power Station.

It would be difficult to get nearer the centre of Ireland than Birr, where the Irish Free State Telegraph authorities are considering a site for the new high-power broadcasting station. Birr is a small town in King's County, not far from the Slieve Bloom Mountains, and, judging from a map view of the district, should be an ideal spot for a station whose service area must cover practically the whole country.

○○○○

A Friendly Visit.

The B.B.C. and the Free State broadcasting authorities are very good friends. Belfast, Dublin and Cork frequently collaborate in S.B. programmes, and artists are occasionally exchanged. In the near future Mr. Seames Clandillon, Musical Director of the I.F.S. broadcasting service, is to pay a special visit to the Belfast studio to organise a programme of folk music.

○○○○

Famous Authors and the Microphone.

Sir James Barrie is to broadcast for the second time on Saturday, June 7th, when he receives the freedom of his birthplace, Kirriemuir, better known as "Thrums."

There can now be very few famous British literary men who have not broadcast. Only two, so far as I am aware, have resolutely declined to face the microphone. They are Rudyard Kipling and Arnold Bennett.

Broadcast
Brevities

By Our Special Correspondent

Lugubrious Publicity.

The New Jersey "mortician" who recently asked for transmissions of funeral music would sympathise with the undertaker who has been sharply rebuked by the French journal *Charivari* for broadcasting "lugubrious publicity" from one of the Paris stations. To celebrate the fiftieth anniversary of his start in business the undertaker broadcast an offer to reduce his fees by 30 per cent. on all orders received within a week.

○○○○

Golf Championship Described.

An eye-witness account of the Open Golf Championship will be relayed from Hoylake to the National transmitters on June 20. The morning round will be described at 1 p.m. and the afternoon round at 6 p.m.

FUTURE FEATURES.

National (261 and 1,554 metres).
MAY 25TH.—Religious service relayed from Southwark Cathedral, with an address by Archbishop Lord Davidson.

MAY 26TH.—Northern promenade concert (from Manchester).

MAY 28TH.—"La Basoche," a comic opera by André Messager.

MAY 29TH.—Opera relayed from Covent Garden.

MAY 30TH.—"Copy," a play.

MAY 31ST.—Opening ceremony by H.R.H. Prince George, of Bristol Airport.

London Regional.

MAY 25TH.—String orchestral concert.

MAY 26TH.—"La Basoche," a comic opera by André Messager.

MAY 27TH.—"Talkie Town," a "super special."

MAY 29TH.—Northern promenade concert (from Manchester).

MAY 30TH.—Opera relayed from Covent Garden.

Midland Regional.

MAY 27TH.—"The Girl from _____," a musical comedy reminiscence.

MAY 29TH.—Old folks' programme of music and songs.

MAY 30TH.—"Ballroom Memories," orchestral programme.

West Regional (Cardiff).

MAY 31ST.—International Air Pageant. Official opening by H.R.H. Prince George of Bristol Municipal Airport.

Manchester.

MAY 27TH.—"Nowt Wrang," a comedy by F. A. Carter.

Glasgow.

MAY 27TH.—A one-man revue.

Belfast.

MAY 27TH.—"Loaves and Fishes," a comedy by Charles K. Ayre.

The "T.T."

Motor-cyclists will gather round the loud speakers on June 20th when a running commentary is to be given on the Senior T.T. Race in the Isle of Man.

○○○○

Excelsior.

The B.B.C. engineers are nothing if not sentimental. Last week there was a pathetic little competition among some of their number for the honour of being the last person to sit on the top of the remaining mast in Oxford Street. The winner, who shall be nameless, remained *in situ* until convinced that the mast had developed its maximum swing of about 6 feet.

○○○○

The Clapham Mystery.

Not all the engineers, of course, were on the Oxford Street roof. Some had weightier business in hand, and these included the party at Avenue House, Clapham, the B.B.C.'s research establishment. I hear that some surprising developments are afoot in this department, and that it needs only an earthquake or similar upheaval down Clapham way to disclose several secrets which would take our minds off the programmes for a few blessed hours.

○○○○

Take It or Leave It.

Grumbles are growing in volume over the alternative-programme farce. The experiences of the last week or two suggest that when a certain type of programme is arranged for, the officials decide that nobody should miss it; therefore it is S.B. to all stations. Sometimes the universal item is an opera, sometimes a "National" lecture; nearly always it is an item which can please only a portion of the community.

○○○○

Broken Promises.

This flouting of all the promises which heralded the regional scheme is officially explained as being one due to the need for economy. The excuse is very difficult to accept when one considers the relatively small expense entailed by the engagement of a quintette or other small musical combination to provide light relief to a heavy main programme. To send out the same material from both stations at Brookmans Park seems much more wasteful.

○○○○

Broadcast from Inverness.

June 13th will be a day of excitement in Inverness. On that day the Freedom of the city will be presented to Mr. Ramsay Macdonald, Mr. Stanley Baldwin and Sir Murdoch Macdonald. The ceremony will be broadcast.

○○○○

Prime Minister at the Microphone.

The Prime Minister will broadcast in the Empire Day programme from a Savoy Hill studio. The feature programme is "The Empire as Communication, or How the Sun Never Sets," and in it a panorama in sound will be unfolded from the Mother Country to "East of Suez."

B 26

READERS' PROBLEMS



"The Wireless World" Supplies a Free Service of Technical Information.

The Service is subject to the rules of the Department, which are printed below; these must be strictly enforced, in the interest of readers themselves. A selection of queries of general interest is dealt with below, in some cases at greater length than would be possible in a letter.

Stability by De-sensitising.

My receiver is a conventional H.F.-det.-2 L.F. combination, with resistance- and transformer-coupled L.F. amplifier stages. Its range is more than adequate, but I am troubled by frequent motor boating or L.F. oscillation, in spite of having taken the usual precautions. It has been discovered that motor boating can be stopped entirely by connecting a pair of phones across the primary winding of the L.F. transformer; does this fact convey any information to you as to the probable cause of the trouble?

C. D. T.

By shunting the transformer primary by an impedance of relatively much lower value than its own, the magnification of the stage is greatly reduced, particularly with regard to the lower frequencies, and it is quite natural that this addition should reduce the tendency towards self-oscillation. We are afraid, however, that your description of the trouble does not help us to diagnose its cause, and we can do little but make the obvious and not very helpful statement that there is certainly some form of undesirable interaction between the various circuits. If you will send us a circuit diagram of the receiver, and also information as to the source of anode supply, it is probable that we shall be able to make some suggestions.

o o o o

Measuring Bias Eliminator Voltage.

With regard to the extemporised grid bias eliminator described in the "Readers' Problems" section of your issue for May 7th, can you suggest an easy way of determining the voltage existing across the various output terminals under operating conditions? I realise that on account of the high resistance in circuit, it would be impossible to measure them with any degree of accuracy with an ordinary voltmeter.

B. J.

It is not easy to measure the voltage output of a device of this sort, and, indeed, it is seldom necessary that one should have precise information on this point. As a rule it will be sufficient to assume that the total voltage existing across the potential divider is slightly less than the R.M.S. output of the rectifier power transformer, and that the voltage between the positive output terminal and any negative tapping point is directly proportional to the amount of resistance in circuit.

B 27

If direct measurement is to be undertaken, we suggest that the existing output valve on your set should be converted into a form of valve voltmeter in the manner indicated in Fig. 1. The eliminator should be connected across the grid circuit in the manner indicated, and the reading of the plate milliammeter should be noted. Having removed the eliminator, replace it by a bias battery, adjusting its voltage until the same reading of anode current is restored, when it will be indicated that the grid voltage applied from the cells is equal to that delivered by the eliminator.

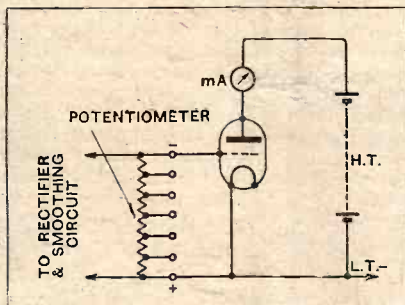

Fig. 1.—An extemporised valve voltmeter for measuring the voltage output of a bias eliminator by the method of comparison.

If it happens that the eliminator voltage is greater than the valve can handle, it will be necessary to apply a convenient fraction of the total by joining the grid lead to one of the tapping points.

RULES.

- (1.) A query must be accompanied by a COUPON removed from the advertisement pages of the CURRENT ISSUE.
- (2.) Only one question (which must deal with a single specific point) can be answered. Letters must be concisely worded and headed "Information Department."
- (3.) Queries must be written on one side of the paper and diagrams drawn on a separate sheet. A self-addressed stamped envelope must be enclosed for postal reply.
- (4.) Designs or circuit diagrams for complete receivers or eliminators cannot ordinarily be given; under present-day conditions justice cannot be done to questions of this kind in the course of a letter.
- (5.) Practical wiring plans cannot be supplied or considered.
- (6.) Designs for components such as L.F. chokes, power transformers, complex coil assemblies, etc., cannot be supplied.
- (7.) Queries arising from the construction or operation of receivers must be confined to constructional sets described in "The Wireless World"; to standard manufactured receivers; or to "kit" sets that have been reviewed.

A 3-unit Receiver.

Although my present receiver does not include the necessary H.F. amplifier, I am thinking of building the "Short-wave Adaptor" described in your issue of April 23rd, and also of constructing a high-frequency unit to interpose between the receiver and the super-heterodyne unit. Do you think that the arrangement shown in Fig. 2, "Readers' Problems" section, April 2nd, would be suitable?

F. G. R.

Yes, this H.F. amplifying unit, which is of simple and straightforward design, would probably work quite well in conjunction with your set and the short-wave adaptor, but do not attempt to add the latter until the receiver-amplifier combination has been persuaded to work in a completely satisfactory and stable manner.

o o o o

Logical Conclusions.

My set is so arranged that a pick-up may be inserted in the grid circuit of the anode bend detector. This valve is preceded by an S.G. high-frequency amplifying stage and is followed by two resistance-coupled L.F. magnifiers. Results are as near perfection as one could wish when the set is used for gramophone reproduction, but its sensitivity as a radio receiver is most disappointing.

I suppose that it is safe to assume that the detector and L.F. valves are in order, and that there must be some fault in the H.F. stage; do you think it would be worth my while to change over from a tuned anode coupling to a double-wound transformer?

A. T. K.

It would certainly seem likely that your H.F. stage is not effective, but it cannot be concluded definitely that the detector is free from blame. When this valve is performing its normal function of rectifying, it may be that some part of the circuit associated with it is in need of attention; for instance, its bias value may be unsuitable, or the anode circuit load may be incorrectly proportioned.

It is a mistake to assume that the transformer method of H.F. coupling is inherently more sensitive than the alternative tuned anode scheme, and unless you are troubled with instability there is no real point in changing over.

Loading a Frame Aerial.

I have made a very successful two-valve det.-L.F. portable, using a form of Hartley circuit, with differential reaction control. The receiver was made for work on the medium wave-band only, but I now find that occasions sometimes arise where the ability to receive long wavelengths would be an advantage. Will you please tell me how to connect a loading coil? If possible, I wish to avoid switching.

N. T. S.

The necessary loading coil must be inserted at the centre point of the frame aerial, and provision must be made in some way to transfer the detector grid return lead to the centre point of the added coil.

We think that the arrangement shown in Fig. 2 (which has already been described in these columns as applicable to a very similar type of set) will meet the case. A coil socket is wired in series with the frame aerial, and for medium wave reception this is short-circuited by means of a plug with its terminals joined

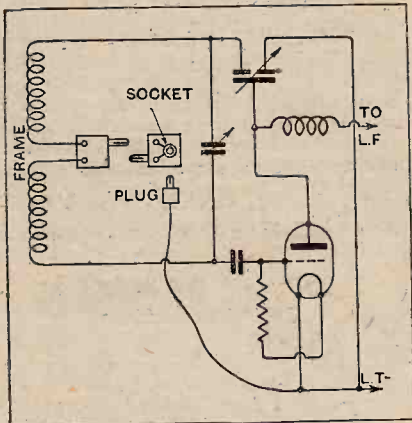

Fig. 2.—A convenient method of loading a centre-tapped frame aerial.

together, and a plug and socket mounted in the manner indicated for connection of the return lead. When changing over for long waves, the short-circuiting plug is replaced by the loading coil, and the return lead plug is connected to its centre point.

○○○○

Smoothing for H.F. Amplifiers.

In designing an A.C. receiver with two transformer-coupled H.F. stages, would it not be permissible to effect an economy by observing less extensive precautions than usual in smoothing the anode feed for the high-frequency amplifying valves?

It seems to me that any ripple or hum that may be introduced in these early stages will not be passed on by the H.F. couplings, and so will not be transferred to the loud speaker via the detector and L.F. valves.

N. M. J.

It is a mistake to imagine that hum cannot be transferred to the L.F. amplifier merely because the H.F. couplings

are incapable of passing on an audio-frequency ripple. As a matter of fact, high-frequency currents in the tuned circuits of a receiver are modulated by impressed hum in just the same way as they are modulated by speech-frequency variations in a telephony transmitter. This modulation, with its H.F. "carrier," is as readily passed on by a double-wound transformer as by any other form of intervalve coupling.

As a consequence, it should be clear that adequate smoothing is necessary for H.F. anode-feed circuits: shortcomings in this respect are generally indicated by an increase in hum resulting when the receiver circuits are tuned to a carrier wave.

○○○○

Frame Aerial Reception.

Do you think that a two-valve frame-aerial set with a single H.F. amplifying stage followed by a detector should be sufficiently sensitive for reception of two or three of the British Stations and several of the more powerful Continental transmissions? Needless to say, my query refers to headphone reception; I live in rooms, and am unable to use a loud speaker.

D. F. P.

It is difficult to give a definite answer to your question, but we fear it would be over-optimistic to suggest that an H.F. det. receiver of this kind will have sufficient sensitivity for your needs. Reception of this sort of the desired stations would doubtless be achieved, particularly after dark, provided that your frame aerial is reasonably large, but for consistent results we would certainly recommend the addition of a second H.F. stage.

○○○○

An A.C. "Megavox."

Will you please tell me how the "Megavox III" receiver may be converted for use with A.C. valves? It is realised that the filament circuits must be altered, but I am not clear as to whether any other modifications would become necessary.

R. S.

A highly specialised receiver of this particular type does not lend itself very readily to modification in this way, and in the limited scope of a letter we hardly feel capable of discussing the matter adequately.

It would probably be wise to substitute an H.F. transformer for the present tuned anode system. Furthermore, to attain anything approaching the full magnification of which A.C. valves are capable, it would be necessary to use more comprehensive screening.

○○○○

Reaction Winding.

In the article describing the "Super-heterodyne Short-wave Adaptor," in your issue of April 23rd, no mention is made of the gauge of wire to be used for the reaction winding of the coil assembly. Will you please give me information on this point?

E. R. S.

As is usual in cases of this sort, any fairly fine covered wire may be used; its exact gauge is immaterial. We suggest No. 36 D.S.C. wire.

Power Grid Detection.

With reference to the articles on power grid detection in your issue of May 7th, will you please tell me if it would be possible to substitute an L.F. choke for the suggested feed resistance in the detector anode circuit? My reason for asking this is that the maximum voltage that I have available amounts to no more than 200, and so the loss in the resistance would bring about an excessive reduction in actual plate voltage.

L. C. P.

Experiments made with choke feed would indicate that it is not altogether satisfactory, and that it is extremely difficult to prevent motor boating when it is used. This is because the impedance of a choke at very low frequencies is not sufficiently high for adequate "decoupling."

FOREIGN BROADCAST GUIDE.**LANGENBERG**

(Germany).

Geographical Position: 7° 8' E. 51° 12' N.
Approximate air line from London: 307 miles.

Wavelength: 473 m. Frequency: 635 kc.
Power: 13 kW.

Time*: Central European (one hour in advance of G.M.T.).

* B.S.T. coincides with C.E.T.

Standard Daily Transmissions.

06.45 B.S.T. Physical exercises (exc. Sunday);
07.00 gramophone records, also relay of concert from some Rhineland Spa; 10.15 gramophone records, news, broadcast to schools; 12.55 time signal from Nauen; 13.00 luncheon concert; 17.30 Vesper concert; 20.00 main evening programme, followed by Café broadcasts from Cologne, Muenster or Dortmund, etc. Closes down at midnight (Tues. exc.). Dance music broadcast on Saturdays from midnight until 01.00 (Sundays).

Langenberg acts as high power relay to the Cologne, Muenster and Aachen common-wave stations.

Male announcers only. Call: *Achtung! Hier Langenberg und die Westdeutschen Gleichwellensender Coeln, Muenster und Aachen*, frequently abbreviated to *Achtung Coeln*, the main programmes being taken from that studio.

Interval Signal: Chimes of five bells, as under, repeated *ad lib.*

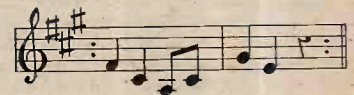

Closes down as other German stations by playing *Deutschland ueber Alles* (Haydn's Hymn: Austria).

Transmissions are S.B. from Cologne (2 kW.), Aachen (0.35 kW.), and Muenster (0.5 kW.) on a common wavelength of 227 m. (1,319 kc.).

THE BEST 2 Volt POWER VALVE EVER PRODUCED...



**P. 240
PRICE
15/-**

All Mazda Valves are the best of their types and their use will give a wonderfully improved performance to any set.

What do you expect of a power valve? You expect it to have a large power handling capacity (which means low impedance) and high amplification in order to get a large output with a minimum number of valves. If you are a user of 2-volt valves the Mazda P.240 must inevitably be your choice because its mutual conductance is higher than that of any other valve.

As the best valve is the one with the highest mutual conductance it will be obvious that the Mazda P.240 will give the best results. It is, in fact, so good that it will satisfactorily drive a moving coil loud speaker.

THESE FIGURES PROVE IT . . .

Filament Volts	...	2.0	Anode A.C. Resistance (ohms)	...	1,900
" Amps	...	0.4	Mutual A.C. Conductance (MA/V)	...	3.7
Max. H.T. Bat. V.	...	150	Constants taken at $E_a=100; E_g=0.$		
Amplification Factor	...	7			

The Amazing

MAZDA RADIO VALVES



THE EDISON SWAN ELECTRIC CO., LTD.,
Radio Division,
1a, Newman Street, Oxford Street, W.1.
Showrooms in all the Principal Towns.

EDISWAN

V.45.

GREAT REMOVAL SALE!

OF BRAND NEW SURPLUS AND BANKRUPT STOCKS.

T. W. THOMPSON & CO. (Formerly of Greenwich)
 HAVE NOW TAKEN MORE CONVENIENT PREMISES AT—
14 and 17, STRUTTON GROUND, VICTORIA ST., S.W.1.

H.T. Mains Units. By Leading British Maker. Input 200/500 volts A.C., output up to 160 volts 30 M.A., 2 Pos. outputs, one variable. Fitted Westinghouse Metal Rectifier. Brand new, ready for use. To-day's value £7, price to clear, guaranteed, 52/6. Passenger Train 2/6. The greatest bargain ever offered.

H.T. Mains Units with Valve Rectification, all mains inputs, full wave output 200 volts at 40 M.A., complete with valve, brand new, 52/6, carriage 2/6. Half Wave output 350 volts at 100 M.A. complete with 2 valves 62/6, carriage 2/6. These high output sets are highly suitable for power amplifiers.

Fellows' Little Giant 3-valve Sets, in oak Pedestal cabinets (4 legs), complete with matched Fellows' Louden Valves, clearance price 40/-. List price £10. Little Giant 2-valve Sets in Pedestal Cabinet with valves, 30/-.
Five-Valve Portable Sets, by leading maker, in real hide case, very latest circuit with Mullard Leaks, nickel alloy transformers, Six-Sixty Speaker, and all the very finest components. These sets are being sold to-day at 16 Gns., our Clearance price 8 Gns., Passenger Train, 3/-. all stations guaranteed. Sets are sent out complete in working order. Cannot be repeated.

Cabinet Speakers. We have a few of the very latest improved type Blue Spot Speakers in Oak Drawing Room Pedestal cabinets, 4 legs, with large baffle. Suitable for Dance Halls, Hotels, etc., etc. Clearance £3/17/6. Sketch and particulars on request.

Moving Coil Speakers. A great clearance of these well known speakers, the finest to be obtained. Listed at £15 to-day, our price 5 Gns. All voltages (D.C. and 6-volt).

Sliding Resistances. Slate Former 30 ohms 5 amp., 70 ohms 3 amps. and others. Fine instrument. Job, price 10/8. Post 9d.

Marconiphone D.C. All Power Units. Supplying H.T. and L.T. and G.B. From 200/250 volt D.C. mains. Listed to-day at £5/5/-. To clear, brand new, 50/-. carriage 2/-.
Accumulators, C.A.V. Portable Unspillable, 2 volt 20 amp. (actual), brand new, ready charged with jelly acid, 9/6 each, post 6d. We have a large stock of all size portable accumulators to fit all sets at very low prices. Please send size. Keep a spare for convenience.

Western Electric Headphone. 4,000 ohms, light-weight. List price 17/6 to clear, all brand new, 7/- pair, post 6d.
Fellows' Louden Valves, 4-volt Dullemitter, all new and guaranteed, 1/6 each, post 3d. Power Valves, 1/9, post 3d. List prices, 6/6 and 8/6. Rectifying Valves, 2/6, post 3d.

B.T.H., H.T. and L.T. Generators. Outputs 8 volts 5 amps. and 200/500 volts, 80 milliamperes, ball bearings, brand new, with smoothing condensers. List price £20, to clear 45/-. Useful for all charging stations, power amplifiers and transmission, a real bargain, guaranteed.

Dynamics and Motors. C.A.V. shunt wound 4-pole 30 volt, 10 amp., ball bearings, in new condition, 50/-.

Crompton 50/100 volts, 20/30 amp. £7. Lister engines, brand new, and all size A.C. and D.C. motors shunt regulators, switchboards, motor blowers, moving coil meters, switch-gear, cables, etc., in stock. Please state requirements. The largest stock in London.

OTHER GOODS FOR DISPOSAL. (R.A.F. Morse Practice outfits, 4/6, post 9d.) (Sterling 1in. Spark coils, 5/-. post 1/-.) (Edison Bell Series parallel variometers, 300/1600 meters, 3/-. post 6d.) (Fixed Condensers, 6d. each.) (Variable Condensers, .0003 and .0005, 1/6, post 4d.) (G.P.O. Polarised Relays, 15/-.) (Sounders, 7/6. Morse Keys, 2/-.) (Microphones, 2/-.) (G.P.O. Sensitive Microphone Buttons, 9d. each.) (Sterling Spark Transmitters, 7/6, post 1/-) (Varley 100,000 ohm wire wound Resistances, 2/6, post 3d.) (Fellows' Intervale Transformers, 4/6, post 6d.) (Marconi Zenite Resistances, 2,500 ohms, 2/6, post 6d.) (Single Earphones, 6d. each, post 6d.) (Westinghouse Metal Rectifiers and Transformers.) (Ex Government 8ft. Telephone Cords, 1/3.) (2-volt 80 amp. Accumulators, brand new, 7/-, post 1/-) (Loud Speaker Units, 2/- each, post 9d.) (High Frequency Transformers, as used in the finest portables, 1/6 each, post 4d.) (Plugs and Jacks, 1/- per pair.) (All Mains Electric Bells, 5/- each, post 6d.) (Slow Motion Dials, 1/6 each, post 3d.) (All the very latest 10in. Gramophone Records, 3 for 2/6, post 6d.) Thousands of other bargains.

A visit to the above address will surprise you.

NOTICE. All Goods advertised are genuine surplus and bankruptcy bargains, and are not repeatable at the price. We shall be pleased to answer any enquiries. All goods are on approval against cash. (Please Note Change of Address.)



*"I wish I'd fitted
 a Microfu"*

The "Microfu" is made in various ratings, from 5 milliamperes to 1000 milliamperes, and is suitable for the protection of valves, wireless sets, eliminators and all instruments taking small currents. It fuses with extreme rapidity.

The "Microfu" has behind it the backing of the whole T.C.C. organisation, with its unrivalled and world-wide reputation.

Prices:

Cartridge from 2/-.
 With holder from 2/8.

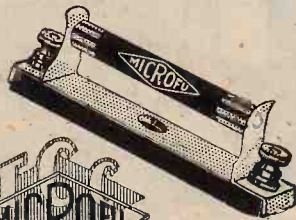

Advt. Telegraph Condenser Co. Ltd., Walce Farm Rd., N. Acton London, W.3

4600

The **BENJAMIN**
 Turntable
 with folding legs
 is unique

A NEW ball-bearing turntable combining several new features, folding legs, which can be opened out for outdoor use, considerably reducing capacity of set to earth, and folded up for indoor use. Fitted with rubber buffers—preventing damage to the polished receiver or article on which the receiver is placed. The smooth running ball bearings make "direction finding" easy.

Price 7/6 complete.

Write for illustrated leaflets on all Benjamin radio products.

Buy
BENJAMIN
 and buy the Best!

THE BENJAMIN ELECTRIC LTD. BRANTWOOD WORKS, TOTTENHAM, N.17.

Mention of "The Wireless World," when writing to advertisers, will ensure prompt attention.

MISCELLANEOUS ADVERTISEMENTS.

NOTICES.

THE CHARGE FOR ADVERTISEMENTS in these columns is:

12 words or less, 2/- and 2d. for every additional word.

Each paragraph is charged separately and name and address must be counted.

ADVERTISEMENTS for these columns are accepted up to FIRST POST on THURSDAY MORNING (previous to date of issue) at the Head Offices of "The Wireless World," Dorset House, Tudor Street, London, E.C.4, or on WEDNESDAY MORNING at the Branch Offices, 19, Hertford Street, Coventry; Guildhall Buildings, Navigation Street, Birmingham; 260, Deansgate, Manchester; 101, St. Vincent Street, Glasgow, G.2.

The proprietors retain the right to refuse or withdraw advertisements at their discretion.

Postal Orders and Cheques sent in payment for advertisements should be made payable to **LLIFFE & SONS Ltd.**, and crossed **Notes being untraceable if lost in transit should not be sent as remittances.**

The proprietors are not responsible for clerical or printers' errors, although every care is taken to avoid mistakes.

For particulars of Box No. Advertisements and Deposit System see previous issue.

IMPORTANT NOTICE.

Owing to the Whitsun Holidays, the issue of "THE WIRELESS WORLD" for June 11th must be closed for press earlier than usual.

MISCELLANEOUS ADVERTISEMENTS for insertion in that issue can be accepted up to FIRST POST WEDNESDAY, June 4th.

RECEIVERS FOR SALE.

SCOTT SESSIONS and Co., Great Britain's Radio Doctors.—Read advertisement under Miscellaneous. [0264]

HIRE a McMichael Portable Set, by day or week, from Alexander Black, Wireless Doctor and Consultant, 55, Ebury St., S.W.1. Sioanne 1655. [0328]

MEGAVOX Three, all mains, A.C., 200-50 volts, long and short wave coils, in cabinet, built "Wireless World" specifications, guarantee, Regentone eliminator; heard any time; £14.—Tipper, 385, Rotherhithe New Rd., S.E.16. [9464]

MARCONIPHONE V2, with 2-stage amplifier, 10 valves or batteries.—George, Chemist, Pentre, Glam. [9500]

OSRAM Music Magnet, nearly new, £6; B.T.H. cone speaker, 42/-; Philips, Mullard, and Climax transformers, 17/- each.—H. Lawrence, Hatfield Peverel, Essex. [9501]

BRANDESET IIIa, complete with valves, used fortnight; £5.—Arrand, Bolton Percy, York. [9502]

PHILIPS 2514 Receiver, 215-230 volt, £15; also Philips latest speaker, cost £5/10, for £3/5; both as new.—Box 6014, c/o The Wireless World. [9469]

STEREOPHONIC Couplers!—Send for new leaflet giving full particulars; the world's finest coupling device, amazing tone, many used in talks.—N. Bonavia-Hunt, 96, Broadhurst Gardens, N.W.6. [9476]

PYE Portable, latest 19 guinea model, unused; £16.—BM/YTOT, London, W.C.1. [9480]

FOR Sale, Marconi Straight Eight, long and short coils, number of valves, grand set; £35, or near offer; private.—Apply M., Dimple Mill, Hartley Wintney, Hants. [9487]

"WIRELESS WORLD" INFORMATION COUPON

This Coupon must accompany any Question sent in before

MAY 28th, 1930

For Particulars of Free Service, see Rules on page 545.



ALL WIRELESS WORLD COILS, DIALS & CABINETS
Short Wave Coils, etc.

B&J. Wireless Co.
2, 3, & 4, Athelstane Mews, Stroud Green Rd., N.4.
Archway 1695.

ELECTRADIX

We have the Biggest Stock of Radio Apparatus, Laboratory Instruments, H.T. and L.T. Dynamometers and Motors, Experimental and Laboratory Gear in this Country.

Immediate delivery from stock to any part of the World. Call and inspect or send addressed envelope for list. Tell us your wants and we will offer something suitable.

ELECTRADIX RADIOS, 218, Upper Thames Street, E.C.4.

City 0191. Electradix, Cent, London.

£9-19-6 COMPLETE. English Valves and Batteries. FIVE-VALVE PORTABLE RECEIVER

Value that you KNOW is genuine.

By **APPLEBY,**

CHAPEL ST., MARYLEBONE, LONDON, N.W.1.

Paddington 8829 (3 lines.)

PAREX



Bakelite Drum Dial
with Escutcheon

5/6

(from stock).

Cabinets, Coils, Valve Holders, etc., for New Kilo-Mag 4 and 1930 Everyman 4.

IDEAL HOME RECEIVER

Special Screen and Panel 17/6.
Set of 3 Coils as specified 45/-.

Order direct from

E. PAROUSSI,

10, Featherstone Buildings, High Holborn, W.C.1

'Phone: Chancery 7010.

SEND TO-DAY FOR OUR FREE 36-PAGE BOOKLET "SOUND ADVICE."



The Finest High-grade Speaker in the World

PERFECT RECEPTION FOR MUSIC LOVERS

BAKER'S 'Selhurst'

OFFICES: 89, Selhurst Rd. S. Norwood, S.E.25. Works: 42, Cherry Orchard Rd., E. Croydon.

Super Power Moving Coil Speaker.

Receivers for Sale.—Contd.

FOR Sale, one Itonia cabinet gramophone and 5-valve Vauxhall portable wireless set, with separate 2-stage 150 volt power amplifier with valves, marvellous reproduction; moderate price.—Apply S. A. Myers, 26, Ambrose Av., Golders Green. Tel.: Speedwell 3786. [9488]

MAGIC Three, with Cosor valves, Lewcos coils, and cabinet cone, brand new, £7; send P.C. for full particulars.—Stephens, "Ravensbourne," Creighton Avenue, East Finchley, N.2. [9490]

MARCONIPHONE 18 Guineas Portable, complete, as new and unused; £14/14.—Pangbourne House, Stafford Rd., Wallington. [9492]

IGRANIC Neurosonic 7-valve Portable, complete with battery box batteries, loud-speaker, cables, etc., hardly used, in perfect condition; cost £75, sacrifice £30, or offer.—Box 6084, c/o The Wireless World. [9493]

LANGHAM Long Range 4-valve Portable, with valves; £10, cost £30.—7, The Polygon, Eccles, Manchester. [9498]

1930 Everyman Four W.W., Ritherdon metal cabinet, beautifully finished, complete with valves, grid, batteries; £17, bargain.—Box 6097, c/o The Wireless World. [9544]

PREMIER 5-valve Portables at Half Price, suit case type, wave change switch, Tungram valves, fully guaranteed; original price £15/15, a few left at £7/15.—Premier Supply Stores, 165, Fleet St., London, E.C.4. [9535]

MARCONI Straight Eight, just overhauled by makers and new valves fitted with high and low coils, mahogany cabinet, like new.—Jones, 18, Benjamin Road, Wrexham. [9528]

REGENTONE Portable Model, A.C. eliminator, almost new; 55/—Freeth, 40, Aberfoyle Rd., Streatham Vale, S.W.16. [9527]

EVERYMAN Four, cabinet speaker, H.T. eliminator and B.T.H. pick-up, complete; £10.—61a, Bridge Rd., East Molesey. [9520]

HALCYON 30-guinea Portable, cabinet and frame slightly damaged, Celestion speaker, 5 Mullard valves; £6/15, really genuine.—4, Brecon Rd., Handsworth, Birmingham. [9519]

SELECTOR Transportable Superhet., Amplion, Mullards, H.T. L.T. accumulators, charging jacks, valley charger, year old; cost £46, set £13, charger 50/-, both £15; demonstration by appointment; various components, half list.—257, Mitcham Lane, S.W.16. [9516]

IGRANIC Neurosonic Seven Transportable Receiver, 250-1800 metres, as new; cost £68, accept £18, genuine.—Killbourn, 29, Stert St., Abingdon. [9511]

BERCLIF D.C.2 All Mains Receiver, 200 to 250 volts D.C.; price £14/10; with valves and royalties, suitable for M.C. speaker; particulars free; trade inquiries specially invited.—Simmonds Bros., Shireland Rd., Smethwick. [8734]

YOUR Old Receiver or Components Taken in Part Exchange for New; write to us before purchasing elsewhere, and obtain expert advice from wireless engineer of 25 years' professional wireless experience; send a list of components or the components themselves, and we will quote you by return post; thousands of satisfied clients.—Scientific Development Co., 57, Guildhall St., Preston. [0226]

ACCUMULATOR HIRE.

DON'T BUY Accumulators or Dry Batteries, join our C.A.V. low- and high-tension accumulator hire service, the largest and best in London; better and cheaper reception with no trouble; regular deliveries within 12 miles of Charing Cross; no deposit, payment on each delivery or by quarterly subscription; over 10,000 satisfied users; explanatory folder post free; 'phone or write to-day.—Radio Service (London), Ltd., 105, Torrione Av., N.W.5. 'Phone: North 0623-45. [8751]

ACCUMULATORS—BATTERIES.

WET H.T. Replacements.—Sacs (capped or uncapped), highest grade, No. 1, 10d. per doz.; No. 2, 1/9 per doz.—See below.

ZINCS.—Best quality (wired), No. 1, 8d. per doz.; No. 2, 9d. per doz.; orders valued 5/- carriage paid, otherwise 6d. for postage.—British Battery Co., Clarendon Rd., Watford, Herts. [0258]

MAKE Your Accumulators Unspillable.—Jellaxit solidifies the acid, improves efficiency, lessens sulphation risk; price 1/6 per bottle; sufficient for 2x40 amp. cells.—From all dealers, or post free from W. Heasman, 16, Boyne Rd., Lewisham. [9547]

EXIDE H.T. Battery, 120 volts, trickle charger (220v.) £5.—Bryant, 2, South Ridgway Place, Wimbledon. [9534]

BARGAIN—120 volts Exide, W.J., perfect; 30/—Vernon, 55, Avignon Rd., S.E.4. [9509]

CHARGERS AND ELIMINATORS.

CHEBROS.—Chebros for all types of transformers and chokes, high grade instruments at a very moderate price; enquiries invited.—Chester Bros., 244, Dalston Lane, London, E.8. [5290]

BUILD Your Eliminator, A.C. Kits, complete, output 120v. 15 m.a., 40/-; 120v. 25 m.a., 52/6.—Scott, 10, East Parade, Ilkley. [9499]

Chargers and Eliminators.—Contd.

TANTALUM and **Lithium** for A.C. Rectifiers; for inexpensive chargers; blue prints for H.T. and L.T., 1/- each; Lithium electrodes, 2.3 and 5.8 amps.—Blackwell's Metallurgical Works, Ltd., Garston, Liverpool. [8298]

PHILIPSON'S Safety High Tension Supply Units for A.C. and D.C. Mains, 200-250 volts 40-60 cycles, also 230 volts 25 cycles.

10/- Down and Small Monthly Payments Secures the Finest H.T. Supply Available.

PHILIPSON'S Safety H.T. Units are Guaranteed for 12 Months Against All Defects.

ALL Models Sold on 7 Days' Approval to Ensure Complete Satisfaction.

PHILIPSON'S Safety H.T. Units are the Cheapest to Install and the Cheapest to Run; £1/17/6 to £6.

WRITE for Our Booklet "Radio Power," which gives illustrations and full particulars.

PHILIPSON'S Safety Loud Speaker Output Filters for All Receivers, power valve, or Pentode; a remarkable output filter at a very low price; 16/6.

PHILIPSON and Co., Ltd., Radio Engineers, Astley Bridge, Bolton. Phone: 2038 Bolton. [0318]

ALWAYS Potential Dividers, 20 m.a. type, all values, with 5 variable tapplings; 2/6, post free.—Below.

ALWAYS Potential Dividers, 50 m.a. type, wire wound, 5 tapping, 20,000 ohms; 4/8, post free.—Below.

If Your Dealer Does Not Stock, send direct and ask for complete list of Always Resistances.—Abingdon Wireless Supplies, Abingdon, Berks. [9478]

400 VOLTS 80 m.a., two variable tapplings, perfect input 200-240 volts, 40-100 cycles, £7. cost double; 2 6mf. condensers, tested 1,000 volts A.C., 10/- each; 3 Metro-Vick AC/S valves, 15/- each; 2 Mullard 164-volt valves, 10/- each; 2 Marconi M.H.L.4 valves, 10/- each; 2 Ferranti panel mounting milliammeters, 0-150, 25/-, 0-1 milliamp., 30/-.—Rogers, 21, New Rd., Brentwood, Essex. [9550]

REGENTONE Model W2 Eliminator, input 200-250, output 200v. at 100 m.a., as new; cost £12, accept £8/5.—Box 6098, c/o The Wireless World. [9545]

SURPLUS Bargains by Post; satisfaction guaranteed.—Ironcore smoothing chokes, 500 ohm., 20 m.a., suitable eliminators, decoupling, output, 2/-; ditto Regentone, 100 m.a., 6/6; 5,000 ohm. 20 m.a., wire-wound resistances, 1/6; multi panel switches, lever, 4-pole changeover, suitable wavechange radiogram, 2/-; post free; approval against cash.—Oliver, 325, Kennington Rd., London, S.E. [9524]

TUNGAR High and Low Tension Charger, R.I. heavy duty L.F. transformer, Varley resistances, 3.1 Dubilier mica condensers; all guaranteed perfect; offers; deposit system.—Rees, Great Western, Ogmere Vale, Glam. [9529]

ZAMPA I.L.T. Eliminator Kit, comprising rectifying unit (incorporating transformer, condensers, Westinghouse H.T.3), necessary condensers, choke, terminals, baseboard, etc., output 120 volts at 20 m.a.; complete, 45/-; 7 days' approval against cash; other Zampa kits and transformers on request.—Mic Wireless Co., Market St., Wellington. [9513]

RADIELLE Model D.C.100 (200-250 D.C.), output 200 volt 100 m.a., and 2 variable tapplings; cost £9/10, sell £3/5; brand new.—Priestley, 74, Aberdeen Rd., Highbury, London, N.5. [9507]

WESTINGHOUSE H.T.1 (200v. 100 m.a.), 47/6; Westinghouse A2 (9v. 2a.), 28/-; A.C./S.G., new, 17/6; P.M.1A, P.M.6D, 4/- each; S625, 5/-.—201, Casewick Rd., West Norwood, S.E.27. [9539]

SAVAGE'S specialise in Wireless Power from the Mains, reliable apparatus at reasonable prices.

SAVAGE'S—Transformer laminations and Bakelite hobbins; intending home constructors should write for list.

SAVAGE'S—Reliable smoothing condensers, 1,500 volt D.C. test, 1 mfd., 2/-; 2 mfd., 3/-; 4 mfd., 5/3; 500 volt D.C. test, 1 mfd., 1/6; 2 mfd., 2/3; 4 mfd., 3/9.

SAVAGE'S—Super smoothing and output chokes, many types available; write for list.

SAVAGE'S—Mains transformer for Westinghouse H.T.4 unit, with additional winding, 4 volts centre tapped 3 amps, 23/-; transformers for other Westinghouse units available.

SAVAGE'S—Mains equipment for new Foreign Listeners Four, transformer N.F.L.4, 33/-; smoothing choke C32G, 20/-; output choke C32O, 20/-.

SAVAGE'S Mains Equipment for Power Pentode Two Transformer, P.P.2, 33/-; output choke, I.C.36P.G., 19/6; smoothing choke, L.C.36G, 18/-.

SAVAGE'S—Mains transformer H.T.4, 500-0-500 volts, 120 m. amps., 7½ volts 3 amps, 6 volts 3 amps, 4 volts 2 amps., 4 volts 1 amp., 4 volts 1 amp., all centre tapped, specially developed for automatic bias; 57/6.

SAVAGE'S—Mains transformers and power chokes are carefully and individually constructed from first class materials, with an exceptionally generous margin of safety.

SAVAGE'S, 146, Bishopsgate, London, E.C.2. Phone: Bishopsgate 6998. [9165]

DYNAMOS, ETC.

A NODE Converter, type C.X., input 12v. output 300, £4, perfect condition; want, B.T.H. pick-up, 1929 model.—Bonavia-Hunt, 96, Broadhurst Gardens, N.W.6. [9477]

CRYPTO Dynamo, 15 volts 10 amps., hardly used; price £4.—Langford, Wootton Rd., Abingdon, Berks [9514]

INEXPENSIVE PUBLIC ADDRESS SPEECH & MUSIC TRANSMISSION MICROPHONE



This thoroughly efficient microphone has been designed for use with any Valve Amplifier, or with Wireless Sets which are adapted to work from a Gramophone Pick-up. When connected to Amplifier through a Microphone Transformer, this Microphone is GUARANTEED to transmit Speech and Music without distortion, with ample volume to fill a large Hall.

Complete on Stand, 10' high, spring suspension and terminals fitted, every part nickel-plated, as illustration, **18/-**

Microphone only, fitted with hooks and terminals, springs supplied, all nickel-plated, **12/6**

Microphone Transformer for the above instrument, **6/-**
FREDK. ADOLPH, Actual Maker, 27, Fitzroy Street, London, W.1. Phone: Museum 3320.

AND HERE IT IS



Electrocet's 2-valve **All-Electric Radio Gramophone.**

SPECIFICATION.

Valves, Osram. Speaker, Blue Spot Unit and Cone. Pick-up, Harlie with volume control. Motor, Collaro. Rectification, Westinghouse Metal.

Finished in Mahogany,

18 Gns.

For A.C. Mains (Royalties included).

Illustrated catalogue post free.

AGENTS WANTED.

THE ELECTROCET RADIO CO., Rowington, Warwickshire.

CABINETS.

DIGBY'S Cabinets.—Table models in solid oak and mahogany; from 11/6 to 71/-.

DIGBY'S Cabinets, fitted with Radion or Reiston ebonite if required.

DIGBY'S Cabinets.—Pedestal model, with separate battery components; from 56/- to £12.

DIGBY'S Cabinets Made to Customers' Own Designs.

DIGBY'S Cabinets.—Write for new 16-page art catalogue.—F. Digby, 9, The Oval, Hackney Rd., E.2. Phone: Bishopsgate 6458. [0128]

KAY'S Cabinets, the greatest range of pedestal cabinets in the kingdom; original creative designs at prices 50% lower than elsewhere; quotations for specials by return; delivery at short notice guaranteed.

RADIOGRAM Cabinets.—A variety of really practical and exclusive models from 60/-; illustrated lists free.

H. KAY, Wireless Cabinet Manufacturer, Mount Pleasant Rd., London, N.17. Phone: Walthamstow 1626. [8963]

COILS, TRANSFORMERS, ETC.

TRANSFORMERS and Chokes for Battery Eliminators.—Chester Bros., 244, Dalston Lane, London, E.8. [8652]

1,000 ohms. Decoupling Resistances, specified for Power Pentode Two; 1/6 each.—Groves Brothers.

600 ohms Decoupling Resistances, specified for new Kilo Mag Four; 1/6 each, post free.—Groves Brothers.

120 ohms Resistances for new Foreign Listeners Four; 1/6 each, post free.—Groves Brothers.

NEW Kilo-Mag Four Coils, 37/6 set; slotted coil transformers, 10 winding, Kilo-Mag Four 12/6 set, 1930 Everyman Four 8/6 set; Kitset 10/6 set; ideal home receiver 9/- set, all post free.—Groves Brothers, St. Mary's Place, Shrewsbury. [9361]

BAND-PASS Filter H.F. Transformers and Aerial Units, for flat tuning and no cutting of sidebands, dual wave; 15/6 each.—Groves Brothers, St. Mary's Place, Shrewsbury. [9362]

VARLEY Pentode Outfit Transformer, 12/- type D R.C. coupler, 6/-; Cosor 410 L.F., 5/-; P.M.24, 12/6; R.I. Push-pull output, 15/-; general purpose transformer, 7/6.—Chapple, 9, Ryfold Rd., Wimbledon Park. [9481]

MILTRO Screen Grid Coils.—Important release to the general public; hitherto only used by manufacturers of successful 3-, 4-, 5-valve sets; this compact tuned-anode and reaction coil has one-hole fixing incorporating wave-change switch; no screens required, even on screen-grid valve; price, with blue print, 7/9, post free, or c.o.d.—Miltro, 743, Commercial Rd., E.14. [9549]

BERCLIF Coils, the standard of excellence, for all "Wireless World" receivers; latest lists post free; trade supplied, all quantities.—Simmonds Bros., Shireland Rd., Smethwick. [8735]

GRAMOPHONES, PICK-UPS, ETC.

B.T.H. Pick-up, Clifphone parallel mounting, just overhauled; 25/-, cost 63/-.—Wilmshurst, 4, Enmore Gardens, S.W.14. [9466]

PAILLIARD Electric Gramophone Motors, with turntable, 200-250v. A.C., unique principle, no brushes or belt, silent, steady, only 2 main moving parts, automatic stop and switch; £4/10; sent on 7 days' approval against cash.—Watkins and Richardson, 1,148, London Rd., Norbury, S.W.16. [9489]

WOODRUFFE Gramophone Pick-up, never used, perfect; £2 (cost £4).—Colonel Kennard, 2, Adelphi Terrace, W.C.2. [9505]

GAMBRELL Novotone, perfect, as new, 65/-; B.T.H. pick-up and tone arm, latest, as new, 30/-.—76, Knighton Rd., Plymouth. [9506]

B.T.H. Pick-ups and Tone Arms, cranked, 22/6 each; send for list.—G2VM, 27a, Bridget St., Rugby. [9518]

B.T.H. Pick-up, with straight tonearm, hardly used; 25/-.—Pebbles, Albany Park Rd., Kingston-on-Thames. [9510]

LOUD-SPEAKERS.

BAKER'S SELHURST RADIO 36-page Booklet, "Sound Advice is Yours for the Asking"; write now for new edition; see displayed advertisement on page 11. [0231]

NEARLY New Goodman's 6v. M.C. Unit, Pentode and H.R. coils, output transformer, 52/6, going on mains; little used Brown pick-up and Kusetta arm, 14/6; P.M.12, 15/6; P.M.22, 17/6.—Baker, Wangford, Beccles. [9503]

MAGNAVOX R4, as new, 6-volt field; 70/-.—Ault, 74, Morley St., Bradford. [9485]

STEEL Pot Magnet, Cromwell Engineering R.K. type, 230 volts, with chassis, rings, B.T.H. transformer; 38/-; needs only diaphragm speech coil to complete.—10, Audley Gardens, Seven Kings. [9484]

PHILIPS 3009 Eliminator, unused; £4, or offer, or exchange Philips 2007 or 2019 speaker.—Burge, 17, Hartfield Crescent, Wimbledon. [9482]

B.T.H. R.K. Speaker Unit, 6-volt, transformer; 55/-.—Box 6024, c/o The Wireless World. [9474]

Mention of "The Wireless World," when writing to advertisers, will ensure prompt attention.

Loud-Speakers.—Contd.

EPOCH Moving Coil Speakers are Masterpieces, designed and produced by master engineers.

EPOCH Moving Coil Speakers are the Standard by which other Speakers are Compared.

EPOCH Moving Coil Speakers are in Use in Many Editorial Offices.

EPOCH Moving Coil Speakers are in Use in Several Famous Laboratories.

EPOCH Moving Coil Speakers are in Use in Many Broadcasting Stations.

EPOCH Moving Coil Speakers are in Use by Most Prominent Musicians.

EPOCH Moving Coil Speakers Bring Unbounded Joy to Thousands upon Thousands of Homes.

EPOCH Moving Coil Speakers, the only speakers that give clear, uncoloured reproduction.

EPOCH Moving Coil Speakers do Render Speech Perfectly and Music Correctly.

EPOCH Moving Coil Speakers Provide the Perfect Illusion of the Artist's Presence.

EPOCH Moving Coil Speakers Represent the Finest Intrinsic Value Ever Offered.

EPOCH Moving Coil Speakers are Guaranteed for a Year, but last for ever.

EPOCH Moving Coil Speakers Bring the Grand Concert out of the Most Modest Set.

EPOCH—You can hear a hundred moving coil speakers, but Epoch is different.

EPOCH—If you own the best set, only by Epoch can you confirm it.

EPOCH—Away with the tin can and cracked banjo reproduction, and install an Epoch.

EPOCH—Away with the drumminess, droniness and huskiness of the average moving coil speakers.

EPOCH—The clearest, sharpest, cleanest reproduction—a marvel of accuracy and beauty.

EPOCH Moving Coil Speaker Models from £2/10 to £30.

EPOCH Moving Coil Speakers.—Models for every requirement and taste.

EPOCH Permanent Magnet Moving Coil Speakers.—Nine models from £3/15.

EPOCH Permanent Magnet Moving Coil Speakers Require no Mains or Batteries.

EPOCH Permanent Magnet Speakers are more Sensitive than most Energised Moving Coil Speakers.

EPOCH Energised Models are the Finest ever put on the Market.

EPOCH Super Cinema Speaker has Created the Biggest Sensation for Many Years.

EPOCH Super Cinema Model is many times as Sensitive as the so-called Supers.

EPOCH Super Cinema Speakers give Enormous Volume from a 1-watt Amplifier.

EPOCH Super Cinema Speakers are used on many 100-watt Amplifiers and never "rattle."

EPOCH Super Cinema Model is Standard on several Talkie Equipments.

EPOCH Super Cinema Model is already in use in over 200 Cinemas.

EPOCH Super Cinema are the only Moving Coil Speakers used in Large Theatres, unaided.

EPOCH Super Cinema Speakers provide alone the Upper as well as the Lower Register.

EPOCH—Other Moving Coil Speakers require the help of exponential horns to provide depth.

EPOCH—A list of many prominent cinemas using the Speakers supplied on request.

EPOCH Speakers are not Made of Tin or Aluminium Stampings, but are sound, solid, engineering jobs.

EPOCH Heartily Invite Comparison, on all counts, with any make, regardless of price or claims.

EPOCH—Don't accept our quality claims without verification, but don't accept any other maker's either.

EPOCH—Order one of 7 days' approval, and test with a switch-over; the only real test.

EPOCH Moving Coil Speakers may be heard in our Demonstration Room Daily.

EPOCH—Our demonstration room is in the heart of London.

EPOCH—Its accessibility has been studied for the convenience of callers.

EPOCH—If you cannot call, write for booklet W.S.3, and approval terms.

EPOCH RADIO MANUFACTURING Co., Ltd., Farringdon Av. (near Ludgate and Holborn Circuses). Phone: Central 1971. [8983]

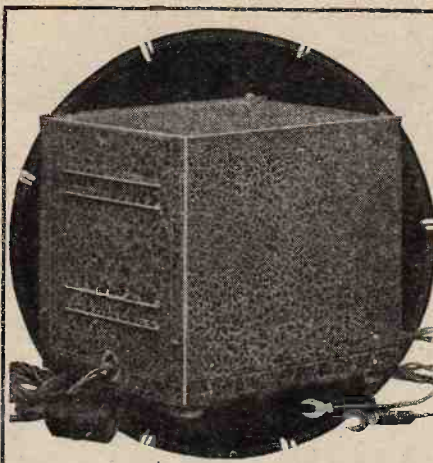

HAVE YOU SEEN THE NEW LOTUS POWER RECTIFIER UNIT for A.C. Mains?

For those who wish to convert their D.C. H.T. Eliminators to A.C., and for the energising of moving coil speakers, the Lotus Power Rectifier Unit is particularly useful. It consists of a Transformer, Rectifying Valve, Condenser and Smoothing Choke, and can be supplied with windings up to 300/300 R.M.S. volts. The Transformer is available with L.T. windings for A.C. Valves, or directly heated Super Power Valves. Totally enclosed in a metal box, and complete with Valve and Royalty paid, the price is £5 - 0 - 0 cash, or 9/3 down and 11 equal monthly payments. Ask your dealer for full details of this new Lotus line.

LOTUS

POWER RECTIFIER

Garnett, Whiteley & Co. Ltd.,
Lotus Works, Mill Lane, Liverpool.

Caution

Loud-Speakers.—Contd.

WESTON Moving Coil Voltammeter, 0.3, 0-15C volts, 0-3, 0-30 amps.; £3, or exchange for eliminator parts or Varley pick-up and arm.—4, Kimbell Gardens, S.W.6. [9479]

WEBSON M.C. Speaker, 6-volt pot; 30/., or nearest.—West Vale Garage, near Halifax. [9470]

PERARDUA Moving Coil Reproducers.—These superlative instruments may be obtained for 15/- down, balance by 5 equal monthly payments; cash prices, 230-volt D.C. £3/3; 6-volt, £3.—R. Vevers, 4, York Rd., Maidenhead. [9551]

MARCONIPHONE Moving Coil Speaker Unit, 6 volts, this year's model, as new; £3/10.—Box 6099, c/o *The Wireless World*. [9546]

FOR Sale, Amplion loud speaker, concert, oak wood horn type, 24in. flare, cost £10, take 40/-; Magic 3-valve set, in case, 44/-—3, Severus Rd., Clapham Junction, S.W. [9548]

MAGNAVON X Cone Speaker, 10½in. cone (£8 model), 6 volts, used 6 hours, otherwise brand new; genuine bargain, £5/10.—Box 6095, c/o *The Wireless World*. [9542]

WE Have 20 Second-hand Loud Speakers in Stock, from 10/-; any new loud speaker above £2 supplied on easy payments.—Bostock and Stonnill, 1, Westbourne Terrace, S.E.23. [9526]

GET Quality.—Double linen speakers, ply case, 14/-; polished mahogany and fret, 19/-; fit any unit.—Parke, 79g, Turnpike Lane, Hornsey, London. [9522]

TRANSMITTERS.

CHEBROS. Chebros. Chebros transformers and chokes of all descriptions, special transformers for transmitting and modulation; chokes a speciality; enquiries invited.—Chester Bros., 244, Dalston Lane, London, E.8. [5240]

QUARTZ Lenses; 2/-; guaranteed oscillate without reaction.—Smith, Bryn Rodyn, Colwyn Bay. [9402]

VALVES.

AMPLIFIER Valve.—If you require power you cannot do better than one of these.

FILAMENT Volts 6, plate volts 400 (maximum), grid bias: 84 volts (approx.), impedance 800 ohms, amplification factor 3.8, mutual conductance 4.35 m.a./volts; price £5/10; see article "The Wireless World," 24th July, 1929, then send to North London Valve Co., Ltd., 22½, Cazenove Rd., Stoke Newington, London, N.16. [9407]

EXPERIMENTER'S Surplus.—L.210, 5/-; 2 P.M.I.H.F.s, 6/6 each; P.M.I.L.F., 6/6; P.M.2, 7/6; P.M.12, 15/-; th. lot, 50/-.—Woodhouse, 25, The Gardens, S.E.22. [9508]

WIRE.

WIRE—Every size and kind from Beaver Engineering Co., 4, Upper Grosvenor Rd., Handsworth, Birmingham. [9384]

ENAMELLED, D.S.C., D.C.C., and resistance, Litz, frame aerial, fuse wires.—Frost, 54, Clerkenwell Rd., E.C.1. [9538]

COMPONENTS, ETC., FOR SALE.

BELLING-LEE Panel Fittings are designed to give an expert finish to any home-constructed set; catalogue post free.—Belling and Lee, Ltd., Queensway Works, Ponders End, Middlesex. [0018]

WESTON Model 301, milliammeters, ammeters, and voltmeters, 21/- each; hot wire ammeters 0-1 amps., 4/-; 0-0.5 amp., 3/-; instrument repairs and alterations; send for list.—The Victoria Electrical Co., 47, High St., Battersea, S.W.11. Established 1910. [8626]

COMPONENTS Lent on Hire.—Details from Alexander Black, Wireless Doctor, 55, Ebury St., S.W.1. Sloane 1655. [0329]

IDEAL for Experimenters.—Dismantled components, condensers, valve holders, L.F. transformers, rheostats, etc.; 5/- per parcel; send to-day; carriage paid.—Hart Radio Supplies, East High St., Falkirk. [9260]

ELECTONE Automatic Time Switch Enables You to set your radio programme in advance, and ensures getting all the items you want, 24 hour clock; price 21/-.—Fredk. J. Gordon and Co., Ltd., 92, Charlotte St., W.1. [9283]

SUPERDYNE Unit, transforms your obsolete 2- or 3-valver into a powerful portable without extra valves.—Particulars, Ledsham, 297, King St., Hammer-smith. [9369]

1,000 ohms. Decoupling Resistances, specified for Power Pentode Two; see advert. under Coils.—Groves Brothers. [9461]

MAZDA A.C./P (new), 12/-; Metvick 4v. filament transformer, 22/-.—Gleed, Optician, Raynes Park. [9497]

THREE D.E.5, one D.E.L.610, two D.E.5a, one D.E.5b, all 5/- each; one U.5, 10/-; two Mazda A.C./P.1, 12/6 each; wanted, Avometer; state lowest cash price.—Williams, 2, Park Lane, Ystrad Mynach, Glam. [9495]

EXPERIMENTER'S Opportunity.—Late manufacturer's stock of special power mains and standard components for disposal; Ferranti, Pye, Celestion, etc., etc.; mostly brand new in original boxes; clearance prices.—Box 6080, c/o *The Wireless World*. [9491]

AMATEUR'S Surplus, various components and valves for sale or exchange; send stamp for list.—Gibson, 184, Howard Rd., Leicester. [9521]

**OVERSEAS READERS
WE SPECIALISE
IN OVERSEAS
BUSINESS.**

**PARTS, SPEAKERS, ELIMINATORS
OR COMPLETE SETS**

Write and tell us exactly what you require and we will buy it for you. It is our business to select suitable apparatus and thus ensure satisfaction to the user. Payment may be made either through "The Wireless World" deposit system or direct to us.

**THE
OVERSEAS TRADING CO.**
144, St. Vincent Street, GLASGOW,
Scotland.
Telegrams: "Tenacity," Glasgow.

EXACT TUNERS

250 to 2,000 metres.

No further coils are required, tuning is as simple as A.B.C., see "Wireless World," January 25th. "We can strongly recommend these tuners." Send postcard for particulars and Circuits FREE to

THE EXACT MANUFACTURING CO.
Croft Works, Priory Place, COVENTRY.

BONA FIDE TRADERS' GUIDE.

Send for our comprehensive Illustrated List. QUICK SERVICE. QUICK SERVICE.

THE QUALITY HOUSE.

PERSEUS MFG. CO., LTD. (Dept. W.W.),
BRANSTONE RD., BURTON-ON-TRENT.

**The simplest,
neatest aid
to selectivity**

Connect the Belling-Lee "Spadenser" to your aerial lead. In every case it will greatly increase the selectivity and in most cases it will entirely eliminate the unwanted station. This new idea combines a series condenser with a Belling-Lee clip-on Spade Terminal. On occasions when the extra selectivity is not required the "Spadenser" is reversed. Write to us for Belling-Lee Handbook "Radio Connections."

only 2/6

BELLING-LEE
FOR EVERY RADIO CONNECTION

Advertisement of Belling & Lee Ltd.,
Queensway Works, Ponders End, Middlesex.



Components, Etc., for Sale.—Contd.

A.C./S. 15/-; P.M.1A, 5/-; Ferranti H.F. kit, 2 dual coils, screen, valve mounting, 15/-; Igranite 3.5:1, L.F., 10/-; Lewcos Q.A., 7/6; 2 Ormond 0.0005, S.L.F., 3/-; ditto 0.00035, 2/6; Ormond 55: 1 S.M. dial, 4/6; Burndept D.P.D.T., 2/6; Lissen No. 210 pick-up, 5/-; all as new.—Lush, Chilcompton, Somerset. [9483]

EXCO H.T. Unit, 1v. 20, D.C. mains, 200-250, 30/-; P.M.24A, super Pentode, 12/6; the above as new.—G. Peppiatt, "The Limes," Highgate Road, London, N.W.5. [9475]

TRITRON U.D.2, 4/6; Marconi L.S.5, 17/6; Blue Spot 66K Unit and chassis, 22/6; 2 T.C.C. 2mfd. condensers, 3/-; all unused; postage paid.—Hargreaves, Ridge St., Barnoldswick, via Colne, Lancs. [9377]

P.M.2, 8/6; P.M.I.H.F., 6/-; P.M.215, S.G., 16/-; Ormond 0.0005, 3/6; Lewcos 250X, 4/6; Lewcos 75C.T., 3/-; Ormond 0.0001, 2/6; panel, 13/7; polished, baseboard, and brackets, 7/6; all perfect, little used.—Blair, 36, Hillhead St., Glasgow, W.2. [9460]

G2FM Has Apparatus for Sale; giving up transmitting; lowest prices asked.—One special type D.C. voltmeter, 0 to thousand, 35/-; one special voltmeter, 0-20, D.C., 7/-; one new milliammeter, 0 to 100, precision, 10/-; one new Morse inker, Siemens, £2/5; one motor generator, input 200-220, 50 cycles, output 900 to 1,100 volts, £6; both almost new; one 0150 Mullard valve, 10/-; variety of other material.—Write McMurray, 4, Deirne Road, Sydenham. Phone: Sydenham 6933. [9465]

ONE D.E.5B, one D.E.5, very little used, 5/6 each; one B4, 7/-; one A.C.F., 10/6 (both unused); one Philips L.T. charger, model 450, for 200v. mains, 25/-.—Box 6012, c/o The Wireless World. [9467]

CLEARANCE Sale.—Nine mahogany pedestal cabinets, £2/5 each; 7 Geophone 0.00025 and 0.0002 variable condensers, 9/6 each; 2 Cydon gang variable condensers, 12/6 each; 2 Bowyer-Lowe gang variable condensers, 10/6 each; 12 assorted variable condensers, lot £1; 8 new B.T.H. B.210.L valves, 6/6 each; 1 Amphion A.R.27 loud-speaker, £2/10.—A. J. Balfour, Wireless Depot, Jedburgh. [9512]

MARCONI Ideal Transformers, 2.7:1, 4:1, 6:1, 10:1; Marconi 50H, power choke, 10/-.—Box 6094, c/o The Wireless World. [9541]

GENUINE Opportunity.—Owner going abroad wishes immediate disposal the following: Eddystone short wave coil kit, complete, 15/-; Baldwin mica diaphragm phones, 17/6; type Z R.I. antimob, 10/-; Marconi Ideal 4:1, 10/-; Wearite H.F. choke, 3/6; 9v. microphone, 5/-; Marconi worm drive 2-coil, 5/6; plug-in coils, short wave up to 250, 17/6 set of 20; 2 car type 6-volt Exides, 85 amp., 25/- each (collected). Following new 6v. valves, S610 screened grid, 12/6; P.M. 6D, P.M. 5B, P.B. 5X, D.E.Q., 5/- each; also 2v. P.M. 1 H.F., P.M. 1A, P.M. 1 L.F., P.M. 2, 3/9 each; also 2 Western Electric 216As, 6v. super power, with holders, 8/6 each; D.F.A.3, D.F.A.4 and 3 Dutch, 6/6 lot; will accept £7/18/6 the lot if collected.—Stiles, "Bradda," Hempstead Rd., Watford. [9537]

FOR Sale.—1 Bowyer-Loewe Pentovox 3-valve set, built by Bowyer-Loewe, with valves, £7/10; 3 Bowyer-Loewe intermediate transformers; 1 filter and condenser to match, £2; 2 Colvern detector precision, 0.0005 condensers, 7/6 each; 1 Ideal transformer, 4 to 1, 15/-; 1 B.T.H. transformer, 2 to 1, 3/6; 1 Ediswan intervalve transformer, 12/6; 1 R.I. Hypermite transformer, 3/-; 2 D.E.3 Marconi valves, 2 D.E.3B Marconi valves, 1 B.T.H. B6 valve, 1 Ediswan valve A.R.06, 18/- the 6; 1 H.T. transformer, R.I., 150 to 4,000 metres, this transformer cost £1/19/6. Make 12/6; all these parts are equal to new.—James Horsfield, Newsagent, Marple, Cheshire. [9536]

SIFAM Milliammeter, 0-50, 10/-; Marconi U5 valve, 10/-; Igranite Midget reaction condenser, 2/-; all unused.—Knox, 17, Rosedale Av., Middlesbrough. [9515]

M.C. Speakers, pick-ups, cone speakers, microphones, transformers, etc.; send for list.—G2VM, 27a, Bridget St., Rugby. [9517]

RADIO HOUSE, HUDDERSFIELD, issues the Reliability Wireless Guide, which will be sent post free upon request by Messrs. J. H. Taylor and Co., 15, Macaulay St., Huddersfield. [7823]

PART Exchange.—See our advertisement under Receivers for Sale.—Scientific Development Co., 57, Guildhall St., Preston. [0228]

MISCELLANEOUS.

ALEXANDER BLACK,

THE Original Wireless Doctor, will call (London and Home Counties) and cure your set.

CONSULTATIONS by Appointment Without Obligation, sets installed, maintained, and brought up to date, gramophone pick-ups, eliminators, and Webson moving coil speakers demonstrated; purity reproduction specialists.

55 Ebury St., Victoria, S.W.1. Sloane 1655. [0277]

EASY Payments.—We supply, by easy payments, components, accessories, and sets, any make; 10% down, balance spread over 11 months.—Send list of requirements to London Radio Supply Co., 11, Oat Lane, London, E.C.2. [0337]

VOLTMETERS.—Sutra, double reading, 0-8-120, 4/3; triple reading, 0-8-165v., 0-40 m/amps., 6/3; hydrometers, 2/6; post free.—Mitchell, 152, Eya Laue, Peckham, S.E.15. [9486]

POWER CHOKES

guaranteed twelve months, substantially built, for smoothing circuits in eliminators dealing with currents 100 to 300 milliamperes, inductance 30 henries, 8/6 post free

Note change of address

REPAIRS to any make of L.F. Transformer, Loudspeaker or Headphones. All repairs dispatched within 48 HOURS—TWELVE MONTHS' GUARANTEE with each repair. 4/- Post Free. Terms to Trade.

TRANSFORMER REPAIR CO.
Dept. W.,
953, GARRATT LANE, TOOTING, LONDON, S.W.17.

Patent Plug Connectors for Electric Irons.
BAKELITE ADAPTORS with moulded-in contacts, suitable for Eliminators, All Mains Sets, Radio Gramophones, etc.

TURNOCK'S MOULDINGS,
41, High Street, Aston, BIRMINGHAM.

METAL CABINETS
for all Wireless World sets from 22/6. Aluminium screening boxes, all sizes, to order. Standard size from stock, 6x6x6 1/2, price 4/- each.

W. H. PARKER, Sheetmetal Workers,
Back Autumn Terrace, Leeds - Tel. 52859.

SPECIFIED for the "POWER PENTODE TWO"

Polar "Volcon" .0001 5/6.
Polar "Ideal" .0005 12/6.

WINGROVE & ROGERS Ltd.
188-9, Strand, London, W.C.2.



POLAR

Electrically sealed

METAL CABINETS
Complete with Base for 1930 Everyman Four, New Kilomag Four, and W.W. Record III. Jacobean Finish.

TERMS: CASH WITH ORDER Price 57/6.

RIGBY & WOLFENDEN, SHEET METAL WORKERS,
MILNROW RD., ROCHDALE.

"TILTRACK"
Registered Trade Mark
Patent-STEEL STORES System

For the Wireless Experimenter, Factory Factor and Retailer,
Full Particulars from Sole Manufacturer and Patentee:—
BERTRAM THOMAS, Worsley Street, Hulme, MANCHESTER.

METAL CABINETS & SCREENS.
CARRIAGE PAID.

Power Pentode-Two ELIMINATOR BOX, with Baseboard (Cellulose Brown Finish) 9/6
Alum. Chassis IDEAL HOME RECEIVER, with Baseboard 13/6
S.G. Short Wave III SMALL SCREENING BOX, for H.F. Valve 2/6

J. BURDEN & SON, Sheet Metal Works, ALGESTER.

Mention of "The Wireless World," when writing to advertisers, will ensure prompt attention.

Miscellaneous.—Contd.

CALIBRATE Your Set With the C.D.E.S. Calibration Chart, 8d., post free.—C.D.E.S., 98, Cherry Orchard Rd., Croydon. [8612]

SCOTT SESSIONS and Co., Great Britain's Radio doctors, officially approved as wireless repairers by Radio Society of Great Britain and Wireless League; old sets of every type repaired, rebuilt, modernised; send set for immediate quotation.

SCOTT SESSIONS and Co.—New sets constructed with your or our components, guaranteed finest workmanship; we specialise in "The Wireless World" circuits; remember, we have satisfied customers throughout the British Isles and in three Continents; if you so desire, we will design and construct high grade apparatus to suit your special circumstances for quality, range and selectivity.—Tel.: Tudor 5326. Muswell Hill, London, N.10. [0262]

ENGINEERS—Novice or expert; £300, £400, £500 per year or more is within your grasp. In our handbook "Engineering Opportunities," Prof. A. M. Low explains where the good posts abound. This handbook has shown the way to better things to over 20,000 of your fellows. It contains details of A.M.I.Mech.E., A.M.I.E.E., A.M.I.C.E., A.M.I.A.E., A.M.I.Struct.E., Matric., C. and G., G.P.O., etc., Exams., outlines home study courses in all branches of electrical, mechanical, motor and wireless engineering, and shows the unique advantages of our appointments department. Why stay in the Hammer and File Brigade? Send for our free handbook at once, stating branch, post or exam. which interests you.—British Institute of Engineering Technology, 87, Shakespeare House, 29-31, Oxford St., London, W.1. [9280]

BROWN Vee Unit and Chassis, cost £2, sell for 24/6, post free; also "Harnsworth Wireless Encyclopedia," 3 volumes, 15/.—Clinch, 78, Chelmsford Rd., Woodford, E.18. [9533]

PATENT AGENTS.

PATENTS and Trade Marks, British and foreign.—Gee and Co. (H. T. P. Gee, Member R.S.G.B. and A.M.I.R.E.), 51-52, Chancery Lane, London, W.C.2. Phone: Holborn 1525. [0001]

AGENCIES.

AGENTS Wanted in Most A.C. Districts to Demonstrate and Sell Electrosets as Advertised; good commission; 14 days' trial.—The Electroset Radio Co., Rowington, Warwickshire. [9409]

REPRESENTATIVES (part time) and Distributors Wanted Throughout U.K. by Leading Ebonite Manufacturers, generous commission, splendid proposition to live men with connection; state territory.—Trolborgs Ebonite Works, Ltd., Union Place, Wells St., W.1. [9496]

REPAIRS.

SCOTT SESSIONS and Co., Great Britain's radio doctors; read advertisement under Miscellaneous column. [0263]

REPAIRS Returned Post Free, and to ensure satisfaction send remittance after approval of same.—Leeds Wireless Repair Service.

LOUD-SPEAKERS, headphones, rewound to any resistance and remagnetised, 3/-; transformers rewound, 4/-; Blue Spots, Triotrons and 4-pole units, 4/6; work guaranteed.—Leeds Wireless Repair Service, 5, Boston Place, Green Rd., Leeds. [9329]

WANTED.

BROWN of Similar 9-valve Amplifier, a number of Brown P.Q. or Power speakers.—Particulars and price to Baker, 133, Tatalgar St., Gillingham, Kent. [9364]

ALL Types of Electrical and Wireless Apparatus Purchased for Cash; large quantities only.—T. W. Thompson and Co., 17, Strutton Ground, S.W.1. [0331]

MAINS Transformer, 220 input, 300 to 400 output; also pick-up.—Spencer, Botolph's Corner, Sevenoaks. [9523]

TRANSFORMERS, valves, chokes, condensers, coils, resistances, etc.; sell 100 records, mostly new.—Pepper, Wake Green Rd., Birmingham. [9532]

fotos
CONCERT VALVES
THE HEART OF EVERY SET
GENERAL PURPOSE AND POWER
5'6
SUPER POWER 7'6
SCREENED GRID 15'6
PENTODE 18'6

ASK YOUR DEALER
(ACCEPT NO OTHERS)
FOR FOTOS VALVES

Low in price and consumption, but high in performance. Once tried—always used. The cheapest and best.

Write for descriptive Booklet No. F25.
CONCERTON RADIO AND ELECTRICAL CO., LTD.
256/7, Bank Chambers, 329, High Holborn, W.C.
Telephone: Holborn 8667.

The Autocar EVERY FRIDAY, FOURPENCE

Wanted.—Contd.

COLUMBIA Receiving Set 304 for 200 A.C.—Pelly, Pierhead, Eastbourne. [9531]

ALL-ELECTRIC 3- or 4-valve Set and Speaker, Philips preferred; must be cheap.—Rees, 21, Highbury Quadrant, N.5. [9504]

EXCHANGE.

EXCHANGE P.M. 2-volt Pentode for 2-volt Screen Grid; wanted, dual range Tunewell coil, aerial and anode, or Colvern Orgola R2R.—Phillips, 12, Villiers St., Oldham. [9471]

6-VOLT Moving Coil Speaker, also kit Mullard 3 Star parts; exchange reflex, Patheoscope, anything useful, or sell.—43, Equitable St., Milnrow. [9463]

WE Will Accept Your Surplus Apparatus (making you a high allowance) in Part Payment for Any New Apparatus; your enquiry will be dealt with promptly.—Bostock and Stonnill, 1, Westbourne Terrace, S.E.23. [9525]

A.F.5, R.I.28/14h, Choke, and T.C.C. 4mf, or P.625A, for A.F.5C and O.P.M.1C.—Allsopp, 29, Beulah Hill, S.E.19. [9530]

SITUATIONS VACANT.

A MATEUR Constructors Wanted as Agents in A.C. Districts for Eliminator Kits, etc.—Details from Fel-Ectric Radio, 56, Garden St., Sheffield. [9258]

WIRELESS Operating; fees payable after appointment; amateur Morse classes.—Manager, Wireless School, 21, Manor Gardens, London, N.7. [9378]

WIRELESS Services.—The premier telegraph college in the British Isles (established 34 years) gives a sound training to all students, with assured positions on qualification; fees are not disguised under expensive board-residence scheme but are payable by easy instalments, if desired.—Apply for Prospectus, Dept. "W.W.," The London Telegraph Training College, Ltd., Morse House, Earl's Court, S.W.5. [9268]

SOUND Reproducer Section of the British Thomson-Houston Co., Ltd., requires engineers; applicants must give full particulars of technical training and subsequent experience, especially in connection with talkie equipments.—Apply by letter to Construction Dept., B.T.H. Co., Ltd., Rugby. [9472]

SITUATIONS WANTED.

RADIO Engineer (25) desires change to reliable post, 7 years' commercial experience receiver and radio-gramophone design, research work and testing.—Box 5972, c/o The Wireless World. [9382]

WIRELESS Operator (29), 14 years' experience, new first class P.M.G. certificate, requires radio appointment, any capacity.—Box 6013, c/o The Wireless World. [9468]

YOUTH, 20, seeks good situation in radio trade, knowledge of repairs and retail trade.—Box 6023, c/o The Wireless World. [9473]

EX Naval Operator (30), 13 years' radio experience, fitting, testing, maintenance, batteries, etc., excellent references, keenly interested, seeks situation.—Box 6085, c/o The Wireless World. [9494]

YOUNG Man, new P.M.G. certificate, sound wireless, practical and theoretical knowledge, seeks post.—Box 6096, c/o The Wireless World. [9543]

ENGINEER, supervisory experience leading sound film equipment, B.B.C., etc., 17 years radio, good education, personality, desires any reliable post, film, gramophone or radio; disengaged.—Box 6093, c/o The Wireless World. [9540]

BOOKS, INSTRUCTION, ETC.

FREE: Inventor's Guide on Patents.—T. A. A., 253, (W), Gray's Inn Rd., London, W.C.1. [6373]

TELEVISION—The complete authorised book on television (Baird Experimental transmission and receiving, is now ready; order "Television To-day and To-morrow" (Moseley and Barton Chapple), 7/6 net.—Pitman's, Parker St., Kingsway, W.C.2. [9309]

STEP by Step Wireless.—A complete course of instruction for wireless engineers; send 1/- for first 4 weeks.—Clifford Pressland, A.M.I.E.E., Hampton-on-Thames. [0195]

REPAIRED VALVES—AS GOOD AS NEW

When Done By **LUSTROLUX** Ltd.
AND DON'T FORGET "LUSTROLUX" BRITISH-MADE NEW VALVES
The S.G.2. SCREENED GRID VALVE—2 volts only 15/-
"A" Type. 2, 4 & 6 volts H.F. L.F. R.C. POWER 5/- ea.
"Super" Type, Pipless. 2, 4 & 6 H.F. L.F. R.C. POWER 7/- ea.

WHY WASTE MONEY ON NEW VALVES? If you have any damaged RING valves let us repair them. We guarantee that their original characteristics will be retained. They will be as good as new. Try us. You will save money.

ALL RING VALVES REPAIRED. Price as follows:—

L.F. H.F. R.C.	- 5/3	ORIGINAL CHARACTERISTICS GUARANTEED
Power Valve	- 6/3	
Screened Grid	- 11/3	

From your Dealer or Direct from—**LUSTROLUX LTD.**, Lower House Mills, West Bollington, Nr. MACCLESFIELD. Scottish Agent: Messrs. Bothwell Elec. Co., 54, Edginton Street, Glasgow.

INDEX TO ADVERTISEMENTS.

Aldoph, Fredk.	PAGE 12	Gambrell Radio, Ltd.	PAGE 12	Player's	PAGE 8
Apollo Gramophone Co., Ltd.	6	Garnett, Whiteley & Co., Ltd.	13	Potter, H. B., & Co., Ltd.	16
Appleby, E. Hetherington	11	General Electric Co., Ltd.	Cover iv.	Radiogramophone Development Co.	16
B. & J. Wireless Co.	11	Gramo-Radio Amplifiers, Ltd.	5	Regent Radio Supply Co.	4
Baker's "Selhurst" Radio	11	Holzman, L.	1	Rialton Radio	8
Belling & Lee, Ltd.	14	Ijnsen Wireless Co.	16	Rich & Bundy, Ltd.	8
Benjamin Electric, Ltd.	10	London Electric Wire Co. & Smiths, Ltd.	2	Rigby & Woolfenden	14
Burden, J., & Son	14	Lustrolux, Ltd.	15	Scientific Supply Stores	
Burne-Jones & Co., Ltd. (Magnum)		McMichael, L., Ltd.	Cover ii.	Telegraph Condenser Co., Ltd.	Cover i & 10
Celestion, Ltd.	6	M.L. Magneto Synd., Ltd.	4	Thomas, Bertram	14
Cole, E. K., Ltd.	Cover i.	Mullard Wireless Service Co., Ltd.	Cover i & 3	Thompson, T. W., & Co.	10
Concerton Radio & Electrical Co., Ltd.	15	Overseas Trading Co.	14	Transformer Repair Co.	14
Edison Swan Electric Co., Ltd.	6 & 9	Parker, W. H.	14	Turnock's Mouldings	14
Electradix Radios	11	Paroussi, E.	11	Varley (Oliver Pell Control, Ltd.)	
Electrocet Radio Co.	12	Periodical Trade Press & Weekly News- papers Proprietors' Association, Ltd.	Cover iii.	Westinghouse Brake & Saxby Signal Co., Ltd.	7
Exact Mani. Co.	14	Perseus Manf. Co., Ltd.	14	Wilkins & Wright, Ltd.	Cover i.
Exide	2	Philips Lamps, Ltd.		Wingrove & Rogers, Ltd.	14
Ferranti, Ltd.	7			Wright & Weaire, Ltd.	16

Sound in principle

SAYS THE

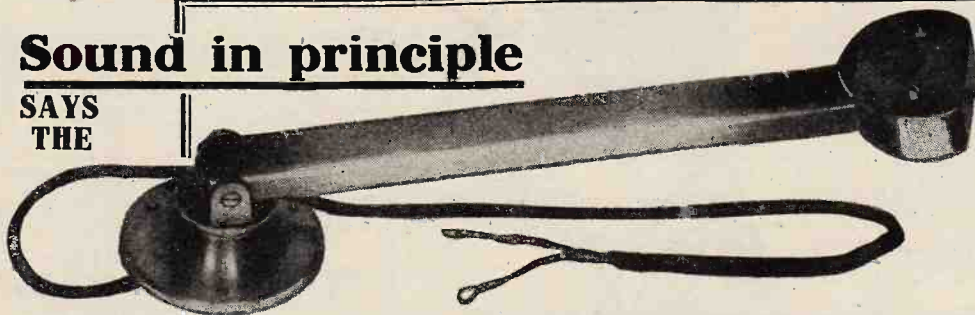

"Wireless World."

THE R.G.D. PICK-UP

is free from resonance. No tracking wear. Highly finished Pick-up in Bronze, Oxidised Silver. Specially constructed for the Coil-driven Speaker.

Price
£2:10:0

Post free.

THE RADIOGRAMPHONE DEVELOPMENT CO.,
ST. PETER'S PLACE, BROAD STREET, BIRMINGHAM.

GUARANTEED

WEARITE

COMPONENTS

MAINS TRANSFORMERS AND L.F. CHOKES

Type	Output	Use	Price.
T.1	4 v 5 a	For Heaters of A.C. Valves For H.T. & L.T.	25/-
T.2	4 v 5 a 5.5 v 2 a 250 v 80 m/a		
T.3	135 v 10 m/a	For Westinghouse Rectifiers Styles H.T.3 & H.T.4	27/6
T.4	135 v 50 m/a 4 v 5 a	As T.3 with addition of wind- ings for A.C. Valve Heater	32/6
T.5	230 v 50 m/a 4 v 5 a	For Westinghouse Rectifier Style H.T.1, also A.C. Valve Heater Winding	32/6

Type	CONSTANT INDUCTANCE L.F. CHOKES.			Price.
	Inductance (Henries)	Resistance (Ohms)	Current-carrying capacity	
L.T. 1	0.1	0.5	1.5 amps	18/6
L.T. 2	0.25	1.5	1.0 "	18/6
H.T. 1	10	100	120 m/a	21/-
H.T. 2	20	350	75 "	21/-
H.T. 3	40	850	50 "	21/-
H.T. 4	100	1850	25 "	21/6
H.T. 5	20	400	30 "	21/6
H.T. 6	60	2500	15 "	15/-

Special Transformer for "Orgola" High Power H.T. Supply Unit **30/-**
H.F. By-Pass Unit **5/-**

Write for free illustrated lists:

WRIGHT & WEAIRE LTD.,
740, HIGH ROAD, TOTTENHAM, N.17. 'Phone: Tottenham 3847/8.



LISENIN

POSITIVE GRIP TERMINALS

(Patent 245,586)

Maintain their lead established five years since, and are acclaimed by the keen Radio experimenter as the ideal terminal. There is one for all radio connections. Write for descriptive leaflet. It's sent free to all "W.W." readers.

Plugs and Sockets with 2 nuts	4d.
Spade Ends	3d.
Standard Wander Plugs	2d.
Chubby Wander Plugs, for portable sets	2d.
Pin Ends	2d.
All Mains Socket and Plug	6d.

Don't forget Pos. Grips overcome unsightly frayed ends to leads. What a boon!

THE LISENIN WIRELESS COMPANY, SLOUGH, BUCKS.



PARFAIT

THE PERFECT EBONITE

SUPPLIED IN SIX FINISHES

Semi-Polished Black
Highly Polished Black
Matt
Semi-Polished Mahogany,
Highly Polished Mahogany
Cube Surface

Obtainable from most wireless dealers.

Advertisement of H. B. Potter & Co., Ltd., Station Buildings, ROCHDALE 3.

Mention of "The Wireless World," when writing to advertisers, will ensure prompt attention.

TELL THE TRADE AND TELL IT FIRST

THESE JOURNALS will assist you to market your products economically and effectively. They put you in direct contact with current trade developments and problems in the industries they represent, and offer expert and technical information to all their subscribers—a service which alone is worth many times the cost of the subscription. The address of any paper in this list will be furnished on request.

- | | | |
|--|---|--|
| Amateur Photographer & Cinematographer. | Electrical Trading & Electricity. | Machinery. |
| Architects' Journal. | Electrics. | Meat Trades' Journal. |
| Architectural Review. | Electric Vehicle & Batteries. | Mechanical World & Engineering Record. |
| Art Trade Journal. | Empire Mail & Overseas Trade. | Men's Wear Organiser. |
| Autocar. | Engineer (The) | Mining Journal, Railway & Commercial Gazette |
| Automobile Engineer. | Engineering & Boiler House Review. | Model Engineer & Practical Electrician. |
| Bakers' & Confectioners' National Association Review. | Experimental Wireless. | Motor. |
| Bioscope. | Export Trader. | Motor Body Building. |
| Brewers' Journal & Hop & Malt Trades Review. | Fertiliser, Feeding Stuffs & Farm Supplies Journal. | Motor Cycling. |
| British & South African Export Gazette. | Footwear Organiser. | Motor Cycle. |
| British Baker. | Freemason & Masonic Illustrated. | Motor Transport. |
| British Engineers' Export Journal. | Fruit, Flower & Vegetable Trades' Journal. | Outfitter. |
| British Export Gazette. | Furnishing Trades' Organiser. | Packing, Packaging & Conveying Gazette. |
| British Journal of Photography. | Gas Engineer. | Paper Box & Bag Maker. |
| British Printer. | Grocer & Oil Trade Review. | Paper Container. |
| British Trade Review. | Grocers' Gazette & Provision Trades' News. | Paper-Maker & British Paper Trade Journal. |
| Broadcaster & Wireless Retailer. | Grocery. | Paper Market. |
| Bus & Coach. | Hotel Review (The) | Photographic Dealer. |
| Chemist & Druggist. | Ice & Cold Storage. | Plumbing Trade Journal. |
| Commercial Motor. | Indian & Eastern Engineer. | Rural Electrification & Electro-Farming. |
| Confectioners' Union & Ice Cream & Soda Fountain Journal. | Indian & Eastern Motors | Sheet Metal Industries. |
| Confectionery Journal. | Indian & Eastern Railways. | Specification. |
| Contractors' Record & Municipal Engineering | India-Rubber Journal. | Talking Machine & Wireless Trade News. |
| Dairy & Creamery Journal. | Ironmonger (The) | Textile Manufacturer. |
| Dairyman. | Journal of Decorative Art. | Textile Weekly. |
| Drapers' Organiser. | Kinematograph Weekly | Tobacco Trade Review. |
| Dyer, Calico Printer, Bleacher, Finisher & Textile Review. | Licensing World. | Tobacco World. |
| Electrical Industries & Investments. | Light Car & Cyclecar. | Unit. |
| Electrical Review. | Locomotive, Railway Carriage & Wagon Review. | Waste Trade World. |
| Electrical Times. | | Wine Trade Review. |
| | | Wireless & Gramophone Export Trader. |
| | | Wireless World & Radio Review. |
| | | Yachting World & Motor Boating Journal. |

Official Handbook, giving particulars of over 500 papers, post free 1/-.

PERIODICAL, TRADE PRESS, & WEEKLY NEWSPAPER PROPRIETORS' ASSOCIATION, Ltd.
Telephone : Central 2441. 6, BOUVERIE STREET, E.C.4. Telegrams : Wenepa, Fleet, London.

Advertisements for "The Wireless World" are only accepted from firms we believe to be thoroughly reliable.



ONE valve for TWO jobs

The
**2-volt SUPER
 POWER VALVE**
 (built like a 6-volt 'Super')
 The latest addition to the
 famous range of
OSRAM Super Power Valves

Osram P.2



Where your H.T. supply is restricted as in a portable set, the new OSRAM P.2 Super-Power Valve is ideal, as it gives the volume and tone quality of a super-power valve with low H.T. current consumption.

Where you have ample H.T. current as when using a power unit or H.T. accumulator, the new OSRAM P.2 Super-Power Valve has sufficient power output to drive a moving coil loud-speaker with wonderful tone quality and volume.

SUPER POWER Osram Valves

**MADE IN
 ENGLAND**

Sold by all Wireless Dealers.

Note these Characteristics.
 Filament Volts..... 2.0 max.
 Filament Current..... **0.2 amps.**
 Anode Volts..... 150 max.
 Amp. Factor..... **6.5**
 Impedance..... **2,300 ohms.**
 Mutual Conductance..... 2.8

FOR ECONOMICAL WIRELESS

PRICE 15/-

Advt. of The General Electric Co., Ltd., Magnet House, Kingsway, London, W.C.2.

Printed for the Publishers, LIFFE & SONS LTD., Dorset House, Tudor Street, London, E.C.4, by The Cornwall Press Ltd., Paris Garden, Stamford Street, London, S.E.1.

Colonial and Foreign Agents:
 UNITED STATES—The International News Co., 131, Varick Street, New York. FRANCE—W. H. Smith & Son, 248, Rue Rivoli, Paris; Hachette et Cie, Rue Réaumur, Paris.
 BELGIUM—W. H. Smith & Son, 78, Marche aux Herbes, Brussels. INDIA—A. H. Wheeler & Co., Bombay, Allahabad and Calcutta. SOUTH AFRICA—Central News Agency, Ltd.
 AUSTRALIA—Gordon & Gotch, Ltd., Melbourne (Victoria), Sydney (N.S.W.), Brisbane (Queensland), Adelaide (S.A.), Perth (W.A.), and Launceston (Tasmania).
 CANADA—The American News Co., Ltd., Toronto, Winnipeg, Vancouver, Montreal, Ottawa, St. John, Halifax, Hamilton; Gordon & Gotch, Ltd., Toronto; Imperial News Co., Toronto, Montreal, Winnipeg, Vancouver, Victoria. NEW ZEALAND—Gordon & Gotch, Ltd., Wellington, Auckland, Christchurch and Dunedin.

MATCHING VALVE AND LOUD SPEAKER.

The **Wireless** **World**
AND RADIO REVIEW

4^D

The Paper for Every Wireless Amateur

Wednesday, May 28th, 1930.



TELSEN
L.F. TRANSFORMERS
Radio's Choice

Have acquired a world-wide reputation for Quality and Value. Built by Specialists in Transformer construction they have set a Quality of Performance above reproach. Your Set will work better with a Telsen Transformer - - - - - Fit one now!

MADE BY TELSEN ELECTRIC CO. LTD.

Radiogrand 12/6
Ratios 3-1 & 5-1
Radiogran: 7-1
Ratio Price 17/6.

TELSEN ELECTRIC CO. LTD., Miller St. Birmingham.



NEW 750-WATT Q.M.B. RADIO OR POWER SWITCH

Latest Model: easily breaks 3 Amps @ 250 V. "Q.M.B." Action: Indicating: Screw Terminals, obviating Soldering: Live Parts Insulated from Lever: One Hole Fixing: Nickel Finish. Small: Neat: Efficient: Guaranteed fully.

For Radio or Power, Gramo-Motor Control, M.C. Speaker Field Switch: Small Motor Switch: Eliminators: Chargers: Portables, etc. As supplied to many leading Manufacturers.

ONLY
2/6

LYONS "B.A.T." No. 730 2/6
(TYPE 728—SOLDER TAGS) NOW 2/3

-CLAUDE LYONS, LIMITED,
Head Office:—76 OLDHALL ST., LIVERPOOL.
LONDON:—40 BUCKINGHAM GATE, S.W.1.

TIP TOP QUALITY
ROCK BOTTOM PRICE



TUNGSRAM
ELECTRIC LAMP
WORKS (GT. BRITAIN) LTD.
Radio Dept., 72, Oxford Street,
London, W.1.
Factories in Austria, Czechoslovakia,
Hungary, Italy, Poland.

TUNGSRAM

BurTon
SELF-LOCATING VALVE HOLDER



1/- each

Pentode
-Valve-
Holders
1/6 each

Patent No.
318708

MANUFACTURED BY
C. F. & H. BurTon

PROGRESS WORKS
WALSALL, ENG.



**I'm the most Powerful—
most Silent—
Challenge me if you will**

H.T. BATTERIES	
<i>For 2-valve Sets (6 m.a.) :</i>	
"WINNER"	60 volts, 7/-
"POPULAR" 2	60 volts, 9/6
<i>For 3- or 4-valve Sets (10-16 m.a.) :</i>	
"POPULAR" POWER	60 volts - - - 13/6
<i>For Sets with Pentode Valves :</i>	
HIGH POWER	60 volts - - - 15/6

I'm



Send for List of Standard Sizes suitable for every set.
THE EVER READY CO. (G.B.), LTD., 21, Hercules Place, Holloway, N.7.

Mention of "The Wireless World," when writing to advertisers, will ensure prompt attention.



Osram A.C. Mains Valves

The OSRAM M.S 4 (Screen Grid) for CONTROLLED High Frequency Amplification

EXPERTS know that the true criterion of efficiency in a screen grid valve is *absence of self capacity*—a very high amplification factor alone does not necessarily mean more distant stations.

The OSRAM M.S4 has the lowest self capacity in circuit of any screen grid valve—only 0.0025 micro-microfarad. This means that, actually, you can get *more range* on your set because the H.F. amplifier can easily be made perfectly stable.

The OSRAM M.S4 improves the quality of the local station, due to absence of uncontrolled reaction effects, and makes station searching easy and sure.

PRICE 25/-

Made in England. Sold by all Wireless Dealers.



STABLE
all round the dial!

Characteristics :

Filament Volts	4.0
Filament Current	...	1.0 amp.	approx.	
Amplification Factor	550	
Impedance	500,000 ohms.	(at screen volts 60)
Mutual Conductance	1.1	
Anode Volts	200 max.	

Advt. of The General Electric Co., Ltd., Magnet House, Kingsway, London, W.C.2.

Advertisements for "The Wireless World" are only accepted from firms we believe to be thoroughly reliable.

A Simple Circuit for a battery eliminator for A.C. Mains

which will give 120 volts, 20 m.a. D.C., sufficient for the majority of modern 3-valve sets (excluding those using pentode valves).

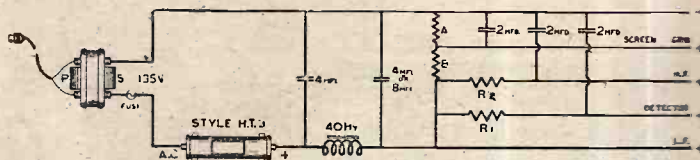

Price 21/-

Full particulars of this and other circuits are given in our 32-page book "The All-Metal Way, 1930." Send a 2d. stamp for a copy.

THE WESTINGHOUSE METAL RECTIFIER TYPE H.T.3

is used in this circuit. This rectifier has nothing in it to wear out—no filaments, moving parts, or chemicals, and consequently does not require periodical replacement.

The Westinghouse Brake & Saxby Signal Co. Ltd., 82, York Road, King's Cross, London, N.1.

VISIBLE PROOF!

Fig. A. WITHOUT Condenser in Circuit.

Fig. B. WITH Condenser in Circuit.

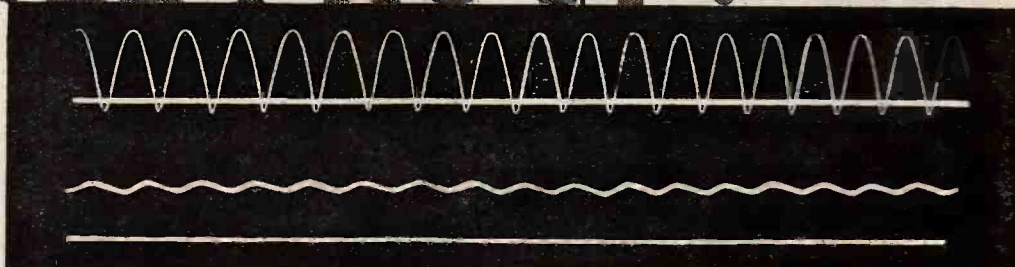

— THAT T.C.C. ELECTROLYTIC CONDENSERS

banish Mains Ripple from Moving Coil Loud Speakers



T.C.C. 2,000 mfd. Electrolytic Condenser. Price 15/-

STUDY this visible evidence—exact reproductions of two oscillograms which illustrate graphically the way in which the T.C.C. Electrolytic Condenser smooths the output of a moving coil loud speaker. Figure A records the voltage applied to the field windings of a moving coil loud speaker energised from A.C. mains by means of a transformer and metal rectifier. Figure B records the voltage when a 2,000 mfd. T.C.C. Electrolytic Condenser is connected in parallel with the field windings. From this visible proof it will be seen that that annoying mains ripple, so prevalent in moving coil reproduction, is completely banished by T.C.C.—the famous "Condenser in the green case." Get one from your Dealer to-day—and enjoy better reproduction!

TELEGRAPH CONDENSER CO., LTD., NORTH ACTON, W.3.



Mention of "The Wireless World," when writing to advertisers, will ensure prompt attention.

VARLEY FOR L.F. CHOKES

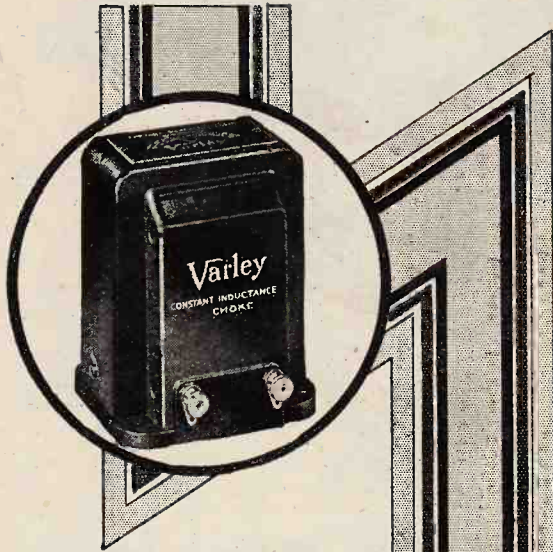

The man who has a real knowledge of the technical side of radio will be quick to appreciate the value of our many years of experience in the winding of chokes for ordinary electrical purposes. This past experience has been of incalculable help in tackling the more difficult problem of producing L.F. Chokes for radio receivers. The relationship between iron and copper, the positioning of the different elements, etc., right down to the actual coil-winding itself—all these problems have been successfully solved in the light of our past experience. The Varley range of L.F. Chokes is second to none in the British Isles—in fact, the new Varley Constant Inductance L.F. Choke (20 henries over the whole range of from 0-100 m.a.) can lay claim to advantages unknown to any other L.F. Choke of the present day.

Full particulars of any of these L.F. Chokes on application.

- Standard L.F. Choke, 20 Henries £1 0 0
- Constant Inductance L.F. Choke, 20 Henries over the whole range 0-100 m.a. - £1 1 0
- Dual L.F. Choke, 75 Henries, series resistance 680 ohms - £1 1 0
- Pentode Output Choke, 2 ratios for high resistance speakers - £1 1 0
- Low Tension L.F. Choke, for 3 amperes - £1 0 0
- Push Pull Output Choke, for high and low resistance speakers £1 1 0

Advertisement of Oliver Pell Control Ltd., Kingsway House, 103, Kingsway, London, W.C.2. Telephone: Holborn 5303.



GET INCREASED EFFICIENCY *and* GREATER SELECTIVITY *with*

Why go to the trouble and expense of erecting an outdoor aerial when you can plug in the Ducon to any light socket and get a selective aerial system? The Ducon fits like an electric bulb a twist and it's in.

There is nothing in the Ducon to go wrong or wear out. It lasts indefinitely and its price is a fraction of the cost of erecting an outdoor aerial.

Ask your dealer to show you the Ducon.



PRICE
5/-

The **DUCON** LIGHT SOCKET AERIAL

If unobtainable from your dealer, write direct to us giving his name and address.

**DUBILIER CONDENSER CO. (1925) LTD.,
DUCON WORKS, VICTORIA RD., N. ACTON, LONDON, W.3.**

Send your Goods by Air

The quickest and most dependable way of transporting goods between England and the Continent is by

IMPERIAL AIRWAYS



THE ONLY BRITISH AIR LINE

It means fewer breakages, because there is less handling. Lower insurance rates for all classes of goods. Quicker customs clearance.

CELESTION KNOW!

Up to last February, Imperial Airways transported approximately 51½ tons of Celestion Loud Speakers across the Channel without damage or loss. The value of these goods was £67,755. Not one of the articles was insured, nor in any case was any packing employed except the ordinary cardboard carton in which the speakers are sold. Messrs. Celestion say that the saving in insurance and packing charges more than compensates for the slightly higher charge for air transport.

In London, goods are collected on telephonic request, or may be handed in to any Freight Agent or to Airways House, Charles Street, Haymarket, S.W.1

Full particulars from any Freight Agent or direct from

IMPERIAL AIRWAYS LTD.

Airways House, Charles St., London, S.W.1

Telephone: Regent 7861 (Night & Day)

Telegrams: Impairlim, London.

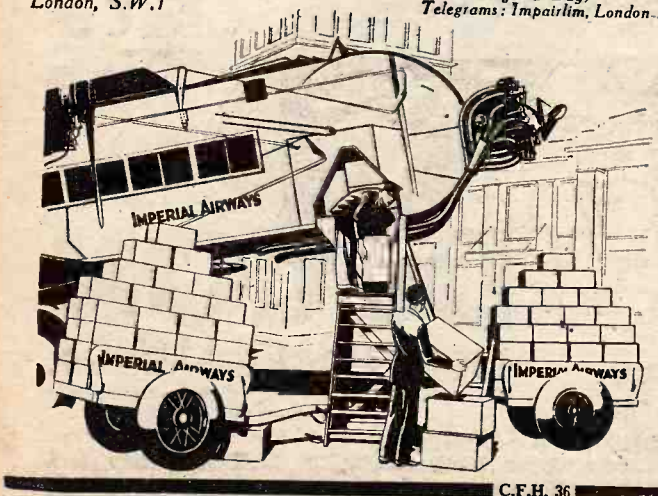

C.F.H. 36

Mention of "The Wireless World," when writing to advertisers, will ensure prompt attention.

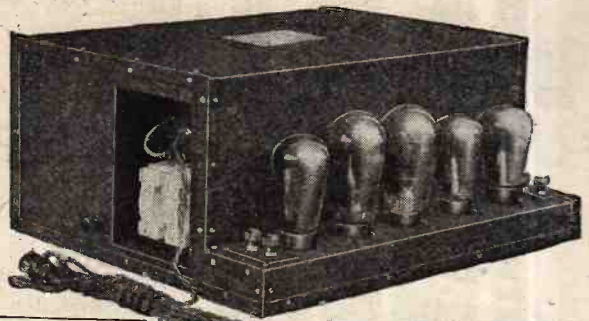

POWER

with perfect quality is the essence of the TRIX AMPLIFIER. Three stages of amplification are provided, with large power valve in the last stage. The whole instrument is enclosed in a case of sheet steel with a crystalline finish. The TRIX AMPLIFIER is ideal for Dance Halls, Cinemas,

Restaurants, Cafés, etc., for the entertainment of 300-500 people. It is complete with valves, fuses, switch, safety plugs, simple input and output connections. All from the mains. Full details from the manufacturers. Write NOW!

TRIX

BRITISH MADE

AMPLIFIER

Manufacturers: ERIC J. LEVER (TRIX) LTD., 89, Clerkenwell Green, London, E.C.1. Phone: Clerkenwell 3014/5.

WIRELESS

DIRECTION FINDING and DIRECTIONAL RECEPTION

(1927)

By R. KEEN, B.Eng. (Hons.).

Second Edition: Revised and Enlarged.

THIS volume deals with the principles of the subject and the constructional details of direction-finding installations, and includes some information concerning aircraft installation. It describes the principles of Direction and Position Finding in this country in such a way that the subject may be grasped easily by engineers tackling this field of wireless work for the first time. Numerous photographs and diagrams are included.

Price 21/- net. By post 21/9.

From leading booksellers or direct from the Publishers:

ILIFFE & SONS LIMITED, Dorset House, Tudor Street, London, E.C.4.

w.w.58

"TILTRACK"

Registered Trade Mark
Patent STEEL STORES System



Now where did I put those Washers?

Do your stores fill you with gloom (like the gentleman in the illustration) every time you look for some component? Then why not install "TILTRACKS" and be certain of finding what you want—AT ONCE—without the usual troublesome search? Made in a variety of types for the Experimenter, the Factor and the Manufacturer. Take the first step towards stores efficiency—Write to-day for our LISTS.

THE "BENCHRACK" (Tiltrack Principle)

A real help for storing small parts such as Terminals, Nuts, Washers, Insulators, etc. Made to stand on the work bench, it enables all small parts needed for the job in progress to be stored where they are immediately to hand. All the trays are tilted so that the parts stored can be seen at a glance, and the front faces of the trays are rounded so that the smallest parts can be swept up the slope with the fingers of one hand. Each tray is provided with patent hinging partitions which can be moved quickly to make larger or smaller compartments. Being so accessible these racks greatly facilitate stocktaking and being all steel there is no danger of fire. The Experimenter will do his jobs much quicker and with greater pleasure, and the Factory will save many pounds per year by installing this Benchrack.

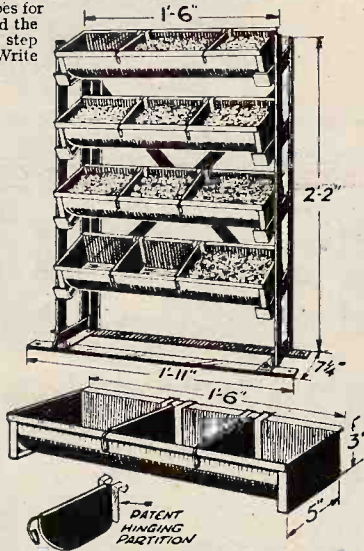

30" F.O.R.

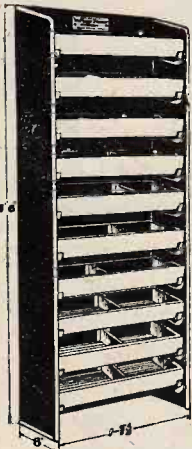

"TILTRACK TWEEIE"

An all-steel rack of great storage capacity. Size 5' 6" high x 19 1/2" wide x 6" deep. All the trays are tilted for easy removal of goods, and are provided with easily moved partitions. The trays themselves can be lifted out from the rack. This rack is a great aid to tidiness, and is a great advance on dark and dismal wooden shelves.

70" F.O.R.

THERE ARE MANY MORE STYLES OF "TILTRACKS." PLEASE SEND FOR LISTS.

Particulars from Manufacturer and Patentee—**Worsley Street, Hulme, MANCHESTER.**
London Office & Showroom.—28, Victoria Street, S.W.1.

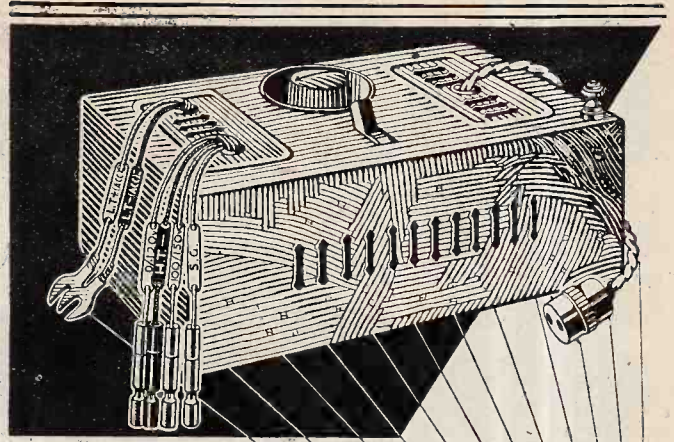

Halve the running costs of your Portable by connecting this new "EKCO" Unit to the Electric Supply

No Batteries. Accumulators now always on charge.

In less than three minutes you can slip the "EKCO" ALL POWER Unit into the space previously occupied by your battery—connect your battery and accumulator leads to the "EKCO" Unit terminals—plug the "EKCO" adaptor into the nearest electric light or power socket and, then—switch-on—that's all!

Specially designed to FIT SNUGLY in any portable, but also for use with all types of sets from one to five valves consuming up to 20 m/a. Constant power—no hum—negligible upkeep costs—lasts a lifetime.

British made for D.C. and A.C. Mains. Westinghouse metal rectifier—flexible output leads and variable tapping in A.C. Models.

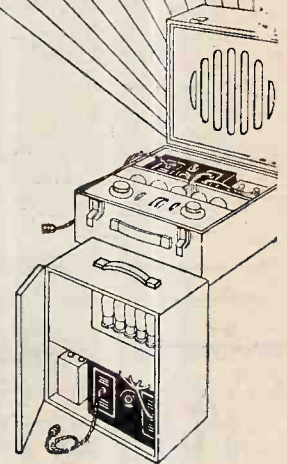

Model C.P. 1 for A.C. Mains combines Trickle Charger and H.T. Unit. Tappings: S.G.; 0-120; 120/150 volts (100 volts only, if required) £6. 0. 0.

Model 1V. 20 for A.C. Mains. Tappings: S.G.; 0-120; 120/150 volts (100 volts only, if required) £4. 12. 6.

Model 1V. 20 for D.C. Mains. Tappings: S.G.; 0-120; 120/150 volts £2. 10. 0.



POWER SUPPLY UNITS for PORTABLES

Obtainable on Easy Payments. Write for NEW illustrated literature!

E. K. Cole, Ltd., Dept. W., "Ekco" Works, Leigh-on-Sea.



Just plug in—that's all!

D.C. to A.C.

If your supply mains are D.C. you can operate an A.C. All-Electric Receiver by using the



D.C. to A.C. ROTARY TRANSFORMER

Can be supplied to run from any voltage 12-250 V.D.C. 40 watt model £13; 85 watt model £19. Recommended and used by Philips Radio, Marconiphone, Burndept, Kolster-Brandes, M.P.A., Etc., Etc.

Write for Pamphlet 596/1 which gives full details

THE M-L MAGNETO SYND. LTD.,
Radio Dept., COVENTRY.

Telephone: 5001.



Grosbolds

Weston sets the world's standard



Model 528, Pocket Size A.C. Tester

A small and reliable instrument essential to maintain accuracy and efficiency in Voltage control. The sensitivity is remarkably high, 6 m.a. for 600 volts with self-contained resistance. The Scale is very legible and the damping excellent. This instrument is capable of continuous service at full load.

Prices from £3.10.0 to £4.15.0

WESTON

ELECTRICAL INSTRUMENT CO., LTD.

15, Great Saffron Hill, London, E.C.1

A.1

Find those distant stations

In the Watmel Binocular H.F. Choke, every detail in design has been carefully investigated with a view to obtaining the greatest possible efficiency in high frequency work. The Choke is of the Inverted "V" windings type, having an extremely restricted field. It is of very low minimum self-capacity, with special low-loss formers and terminals mounted on top. Inductance always remains constant. It is mounted on a moulded Bakelite base, and overall measures only 2 in. long by 2½ in. high.



WATMEL BINOCULAR H.F. CHOKE
Type DX3 6/-
Type DX2 ... 4/-

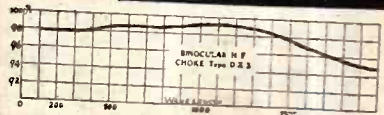

Curve of DX3 Choke

Watmel

★ Send for our Folder No. E.105 showing you how to make up a fine loudspeaker; also folder and Blue-print for building a modern 3-valve set.

WATMEL WIRELESS CO., LTD., Imperial Works, High Street, Edgware.
Telephone: Edgware 0323.

Mention of "The Wireless World," when writing to advertisers, will ensure prompt attention.

M.C.7.
B2

AMAZING SUCCESS OF THE NEW "MAGNET DYNAMIC" SPEAKER



ALL over the country this new Speaker is meeting with tremendous success. Everybody is really astonished at the clear, powerful reproduction which this Speaker affords. On all frequencies it undoubtedly compares favourably with a moving coil loud speaker. The new Hegra "MAGNET DYNAMIC" Loud Speaker embodies a totally new construction, in which unique principles of design are employed. The quality of reproduction is astounding, being equal to that of a moving coil, and yet no field energising current is required. It will handle with ease an input up to 4 watts. It costs no more than the ordinary cone type loud speaker, but will give sufficient volume to fill a large hall.

OBTAINABLE FROM ANY DEALER.

CHASSIS FORM (as illustrated) .. £2 16 0
IN POLISHED WALNUT CABINET .. £5 10 0



M. C. 6.

HYPERCORE

A REVOLUTION IN SMOOTHING AND FILTER OUTPUT L.F. CHOKES

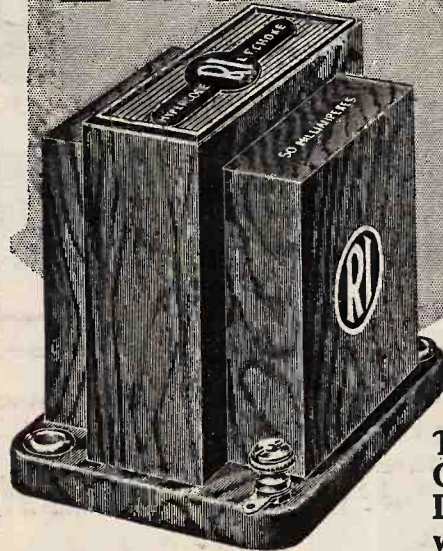

See Article by R.I. Research Dept. in "Wireless World," May 21st, 1930.

The First
Commercial
L.F. CHOKE
with the new

NICKEL IRON CORE

Less than half

the

size and weight

of chokes built with silicon iron cores,
yet having an

INDUCTANCE of 30 HENRIES

"Hypercore" is another remarkable addition to recent developments by the R.I. Research Laboratories. It completes (with "Hypermu" and "Hypermite") an amazing trio of components that together enable set builders to get the absolute best out of modern valves and modern circuits in the smallest space with minimum weight. It sets a new standard in L.F. Choke efficiency in smoothing equipment and filter output circuits.

The "Hypercore" is mounted in a beautiful bakelite moisture-proof case. Overall dimensions are only 2" x 2 1/2" x 2 1/2" high.

17/6

Write for the "Hypercore" folder which gives complete and useful details and diagrams.



12, HYDE STREET, LONDON, W.C.1



A NEW PICK-UP

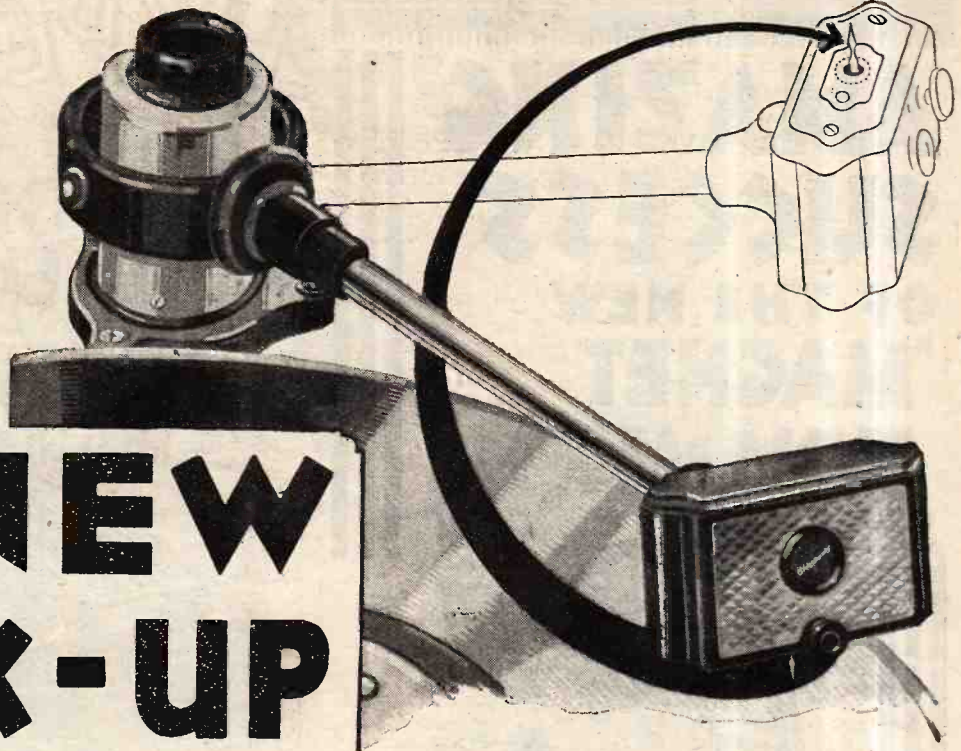

Designed for the true critic and lover of gramophone music this wonderful pick-up will discover new beauty in your gramophone records. Coloration and depth of tone which you have not previously heard will be revealed. All that is incised on the record will be reproduced without over emphasis and without attenuation. Ask any good wireless dealer for a demonstration and you will be both delighted and amazed with the realism of the reproduction. **Price £3.3.0 complete with volume control.**

BLUE SPOT 88

Blue Spot's new pick-up, Blue Spot 88, incorporates all the improvements resulting from years of patient research. Tracking difficulties have been overcome by positioning the needle continuously tangential to the record groove. The tone-arm is mounted on ball bearings giving perfect freedom of movement without risk

of chatter. The volume control works smoothly and noiselessly at all positions. By turning the pick-up over to the right it is automatically held free and clear of the turntable leaving both hands free for changing records and needles. Every detail has been carefully studied to ensure the best possible results.

F. A. HUGHES & CO., LIMITED, 204-6 Great Portland St., London, W.1

'Phone: Museum 8630 (4 lines)

Distributors for Northern England, Scotland and North Wales: H. C. RAWSON (Sheffield and London) LTD., 100 London Road, Sheffield. 'Phone: Sheffield 26006. 22 St. Mary's Parsonage, Manchester. 'Phone: Manchester City 3329

Mention of "The Wireless World," when writing to advertisers, will ensure prompt attention.

The Wireless World

AND
RADIO REVIEW
(18th Year of Publication)

No. 561.

WEDNESDAY, MAY 28TH, 1930.

VOL. XXVI. No. 22.

Editor: HUGH S. POCOCK.
Assistant Editor: F. H. HAYNES.

Editorial Offices: 116-117, FLEET STREET, LONDON, E.C.4
Editorial Telephone: City 9472 (5 lines).

Advertising and Publishing Offices:
DORSET HOUSE, TUDOR STREET, LONDON, E.C.4.
Telephone: City 2847 (13 lines). Telegrams: "Ethaworld, Fleet, London."

COVENTRY: Hertford Street.
Telegrams: "Cyclist, Coventry." Telephone: 5210 Coventry.

BIRMINGHAM: Guildhall Buildings, Navigation Street.
Telegrams: "Autopress, Birmingham." Telephone: 2970 and 2971 Midland.

MANCHESTER: 260, Deansgate.
Telegrams: "Iliffe, Manchester." Telephone: 8970 City (4 lines).

GLASGOW: 101, St. Vincent Street, C.2.
Telegrams: "Iliffe, Glasgow." Telephone: Central 4857.

PUBLISHED WEEKLY.
Subscription Rates: Home, £1 1s. 8d.; Canada, £1 1s. 8d.;
other countries abroad, £1 3s. 10d. per annum.
Entered as Second Class Matter at New York, N.Y.

As many of the circuits and apparatus described in these pages are covered by patents, readers are advised, before making use of them, to satisfy themselves that they would not be infringing patents.

CONTENTS OF THIS ISSUE.

	PAGE
EDITORIAL VIEWS	547
MATCHING VALVE AND LOUD SPEAKER. By A. L. M. SOWERBY	548
THE FIRST INDIRECTLY HEATED PENTODE	552
NOTES ON THE NEW FOREIGN LISTENERS FOUR. By F. H. HAYNES	555
LABORATORY TESTS ON NEW APPARATUS	560
WIRELESS THEORY SIMPLIFIED—PART XXXI. By S. O. PEARSON	562
CURRENT TOPICS	565
BROADCAST BREVITIES	566
PIONEER WORK IN SIGNAL MEASUREMENT	567
CORRESPONDENCE	569
READERS' PROBLEMS	570

ABUSE OF PATENTS.

THE original intention in granting a patent to an inventor was to give him the protection of the State and a monopoly to exploit his invention for his own benefit and for the benefit of those of the community who were to reap whatever advantages his invention provided. There are a number of ways, however, in which the machinery whereby patents are granted can to-day be abused, and a particularly serious example of this abuse occurs when an attempt is made to create a seemingly strong patent position more by virtue of the number of patents owned than their merit of novelty or usefulness.

There are to-day a great many examples, particularly in the radio industry, of patents taken out by big concerns which have so little subject matter that it would not have been worth while for any private individual to endeavour to protect the arrangement, but in the hands of a big concern and in the company of a large number of other patents, the value may be substantially enhanced. Again, it not infrequently happens

that a patent is taken out solely in order to disclose information and thereby make it impossible for a rival firm to obtain a patent, although it may be realised at the time that the specification is drawn up that the patent itself, as a patent, will have no real value.

As matters stand to-day, the Patent Office cannot refuse to grant an application for a patent unless it can be shown that the subject matter is already covered by a prior patent or has received publication in some other way. However convinced the Patent Office may be that an application does not describe a new idea, they cannot, we understand, refuse to grant a patent unless they can produce published evidence to prove that there is no novelty in the proposal.

NOISY LOUD SPEAKERS.

THERE has been a good deal of correspondence in the daily Press during the past few weeks on the subject of noisy loud speakers and the inconvenience which is caused to neighbours when enthusiasts allow the voices of their loud speakers to penetrate into the habitations of their neighbours in such a way as to deprive them of the peaceful enjoyment of the premises.

Some of those who have contributed to the discussion on this topic have urged that special legislation should be introduced to deal with the nuisance, or that the Post Office should employ officials to listen for unreasonable commotion of the air caused by wireless sets, in the same way that they employ scouts to hunt down the persistent oscillator. In our opinion it is quite unnecessary that any special legislation should be introduced. The machinery of the law is quite adequate at present to cope with any difficulties of this nature which may arise. If the wireless enthusiast persists in allowing his reception to interfere with the comfort of his neighbours, he is just as much liable to the correction of the law as he would be if he decided to experiment with obnoxious chemicals and permit the odour to penetrate into his neighbours' houses. We cannot imagine that any reasonable user of wireless would resent an intimation from his neighbours that unreasonable strength of reproduction was an annoyance to them, and we should have no sympathy with those who persisted in causing trouble after they had realised that they were making themselves unpopular by so doing.

It would be a pity for wireless to come into disrepute as a result of lack of consideration for others. We are accustomed to individuals who have come to be known as "road hogs," and amongst so many million listeners there must be a few "ether hogs."

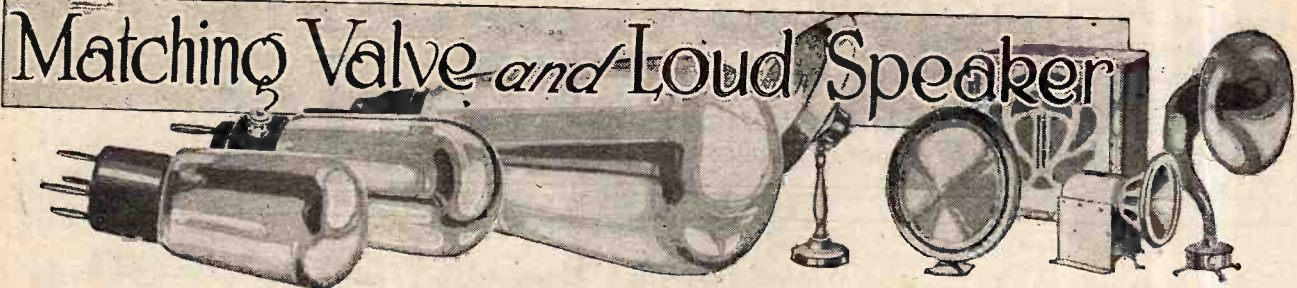

Correct Conditions for Quality Reception Explained.

By A. L. M. SOWERBY, M.Sc.

IN a multi-valve receiver the range, the sensitivity and the quality of reception depend upon those valves which precede the output stage of the set, while the available power for working the loud speaker depends simply and solely on the capabilities of the last valve and on the anode voltage available. We shall, therefore, in this article, limit ourselves to considering the last valve of the set in conjunction, of course, with the anode current supply and the loud speaker.

The first point that arises in choosing an output valve is that of making sure that it will provide, without distortion, the power that is needed. To obtain a rough measure of maximum signal strength, we may multiply the anode voltage that we propose to use by the anode current, in milliamps., that the valve will take, when correctly biased, at that voltage. If the result comes out at much less than 1,500 for triodes, or 800 for pentodes, the valve will hardly provide power enough for even the most modest aspirations. Speech will be a whisper, and music merely a tinkle, unless distortion,¹ in some form or another, is permitted. When the power-consumption just mentioned is reached, the loud speaker will provide quiet, but quite pleasant, entertainment.

If something a little more realistic is wanted, then the power may be increased by choosing either a valve which takes a larger anode current or one that will work with a higher voltage—or both. If the product is brought up to 6,000 for triodes, or about 3,000 for pentodes, the available undistorted sound has risen in sympathy until it has become not far short of the volume given by a modern pedestal gramophone. At the same time the cost of the H.T. supply, unless the mains are to be used, will have gone up in the same

¹ Valves having small anode current, especially in portable sets, often make a surprisingly loud noise without obvious distortion. This result is achieved by deliberately removing the whole of the bass register, an expedient forced by limitations of anode current supply.

proportion. A greater power than this would fail to be appreciated by the average listener, even if he did not actively dislike it; and, if fully used, would shake up the speaker a good deal more than its makers ever intended. A good average value of the voltage-current product for ordinary domestic reception is somewhere round 2,500 for triodes; power enough is then available for reasonable bass reproduction, while the general level of the sound is both loud enough to hear in comfort and quiet enough to make it possible to converse without having to switch off the set first.

The volt-milliamp. product that we have taken as a measure of the volume attainable from the valve is, in reality, the total energy consumption, in milliwatts, of

its plate circuit. The available alternating current power for working the speaker, provided that valve and speaker are suited to one another, is very roughly one-fifth of this in the case of triodes, but is nearer one-third in the case of the more efficient pentode. This accounts for the fact that a smaller anode wattage is suggested as suitable when a pentode is employed.

Having decided, with an eye also upon the cost of maintaining the anode-current supply, on the volume of sound that is considered desirable for our particular case, the next problem is how to get it. It is only too easy to provide power enough for quite a big volume and then, through choosing an output valve that is not suited to the speaker, to fail to persuade that volume to take audible shape. When a triode is used as output valve there is not often serious trouble on this score, for the speakers are designed to follow the average output valve; but it is quite common for either power or quality to suffer to quite a noticeable extent by failure to appreciate the simple law which governs the matching of valve and speaker.

The condition that it is necessary to fulfil in order to obtain from the loud speaker the full amount of sound that the output valve can provide is, on paper, quite simple. It is this: The impedance of the loud

THERE was once a superstition that the amount of noise that could be extracted from a receiver depended in some way or another upon the number of valves that the receiver contained. That superstition is dying a well-merited death, and it is now generally realised that every single milliwatt of power that is passed on to the loud speaker is derived from the anode-current supply, and is handled entirely by the last valve in the set. How to obtain the greatest undistorted output by the correct matching of valve and loud speaker is lucidly explained in this article, which concludes with some interesting notes on the design of the output stage for a pentode.

Matching Valve and Loud Speaker.—

speaker must be double, or a little less than double, that of the output valve.

There might appear at first sight to be nothing very difficult about this, for the resistance of many loud speakers is given by the makers, and is in any case very readily measured. Unfortunately, the direct-current resistance hardly comes into question at all; it is the total impedance to alternating current, which runs into a good many thousand ohms, that has to fulfil the condition just mentioned. This impedance is mostly provided by the inductance of the windings and by various sources of loss; the pure D.C. resistance, except at the very lowest frequencies, contributes only a very small amount of the total. One cannot even argue that a speaker of high resistance will necessarily have a proportionally high impedance. The high value of resistance may be due to the presence of a very large number of turns in the windings—which would, of course, lead to a high total impedance—but it may equally well be due to the design being such that compactness of the coils is necessary, so that fine wire has to be employed to cram even a small inductance into the space available.

Impedance Required, not D.C. Resistance.

A recent article in these pages, entitled "Tests on Cone Units,"² in which the salient points of a large number of loud speaker units were summarised, gave also their impedances at a number of frequencies within the musical range. The information provided by these tests makes it possible to design the output stage of the receiver with more certainty of success than if one had to rely solely upon the makers' advertisements, which seldom contain any information of the slightest electrical significance.

The curves of Fig. 1 represent data taken from this article; they show the relationship between the impedance of the speaker and the frequency of the signal for half a dozen typical units. They show, very clearly, that the relationship between the D.C. resistance (shown against each curve) and the total impedance is a very distant one. True, the speaker unit with the lowest resistance (No. 4) has, over most of the frequency range, the lowest impedance; but then No. 3 has only about half the impedance of No. 5, which is 200 ohms lower in resistance. Or compare No. 6 and No. 1; the former has the greater resistance by a mere 3 per cent., but its average impedance is some 100 per cent. greater than that of No. 1.

These facts make it quite clear that knowledge of the D.C. resistance of a speaker does not help us in the very

least, but that we must focus our attention on the information which, although not provided by the makers of the unit, has recently been made available through these columns.

Even when we have made the distinction between D.C. resistance and impedance, we are not yet freed from our difficulties, for it is not possible to say that the impedance of a speaker is so many ohms. As the curves of Fig. 1 show only too plainly, the speaker has a different impedance for every different frequency in the whole range of musical tones. Moreover, the variation in impedance is very large—far larger than a careless glance at the curves, which are plotted to a logarithmic scale, would suggest. In the case of No. 6, for example, the impedance at 6,400 cycles is nearly twenty times as great as at 50 cycles.

If we precede this speaker with a valve which, under operating conditions, has an A.C. resistance of 3,000 ohms, then the greatest power will be transferred to the speaker at the frequency for which its impedance is about double this figure, namely, at 700 cycles. This, as a reference to the musical scale on Fig. 1 will show, is a note some one and a half octaves above Middle C on the piano. The general tone of music, provided that the speaker is of equal efficiency at all parts of the scale, will therefore be high. It must not be understood that there will be a sharp resonance at 700 cycles; but this frequency will be at the centre of a wide band that is well reproduced, and outside this range the power will gradually tend to fall off.

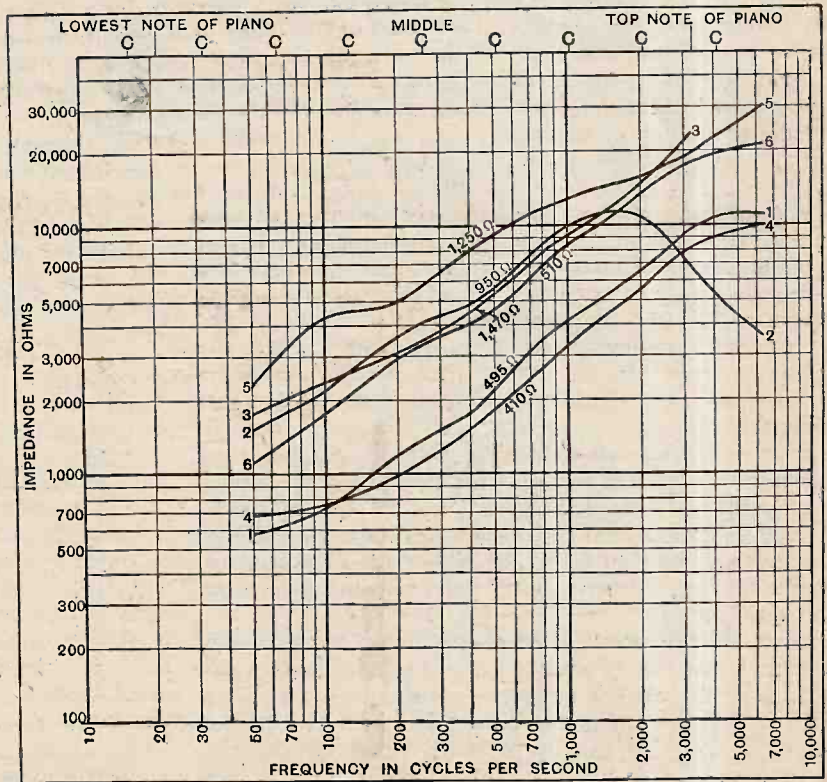

Fig. 1.—Total impedance of typical loud speaker units at different frequencies. The musical scale at the top of the diagram enables the frequency-scale to be interpreted in musical terms.

² *The Wireless World*, Feb. 5th and 12th, 1930.

Matching Valve and Loud Speaker.—

If we halve the effective A.C. resistance of the output valve by putting another valve in parallel with it, the centre of gravity of the music will shift downwards to about 200 cycles, which is nearly two octaves below its original position. A critical ear would notice this change quite definitely, even though the band of frequencies covered is, in either case, so wide as to mask the change quite considerably. The introduction of the

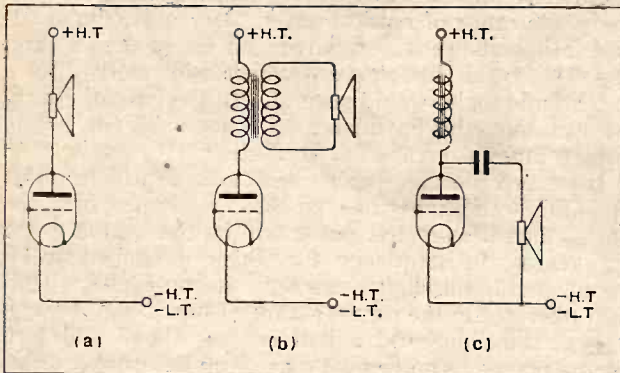

Fig. 2.—No matter whether the loud speaker is connected directly to the valve, as at (a), or through a 1:1 transformer or choke-filter as at (b) and (c), the impedance relations discussed in the text will apply. From the point of view of the signals, with which we are here concerned, all three may be regarded as identical.

second valve in parallel has, however, made another alteration; it has doubled the power available. Owing to the simultaneous change in the pitch of the music it is very doubtful whether this doubling of the power would be noticed at all, for it is the shriller notes, in the neighbourhood of 500 to 800 cycles, that carry most of the suggestion of loudness.

Choosing the Valve to Suit the Speaker.

By comparing the impedances of different speaker units, and making up our minds whether we like a preponderance of bass or of treble notes, we can select from the units available one into which, with the output valve to be used, the maximum of power can be put at whatever frequency our tastes demand. Generally speaking, it is best to aim at attaining the maximum somewhere round Middle C. By so doing we are sure that the whole of the musical scale will be reproduced fairly well, and are sacrificing just about the right amount of apparent loudness for the sake of improving bass response enough to give "body" to the music. It will be noticed that the majority of units are designed to have an impedance that, at Middle C, is about suited to the average "super-power" valve of some 2,500 ohms A.C. resistance.

It is equally possible, of course, if we have already bought a speaker, to reverse the process and find a valve that suits it. In this connection it should not be overlooked that the amount of power that we have decided upon as desirable can be provided either by choosing a high-impedance valve taking a small anode current at a high voltage, or by choosing a low-impedance valve taking a large anode current at a low voltage.

The above discussion has all been based on the assumption that the loud speaker is to be connected directly in the plate circuit of the output valve. Although, if the output valve is small, there is no objection to so doing, it is generally more convenient to use some type of output device to prevent the steady plate current of the valve from passing through the speaker windings. This is specially desirable when the current drawn by the last valve is large, for then an appreciable number of expensive volts are dropped across the loud speaker, which, owing to the need for compactness, is generally wound with fairly fine wire.

Calculating Output Transformer Ratio.

From the point of view of the signals, the two commonest output arrangements, the 1:1 transformer and the choke-filter (b and c respectively in Fig. 2) are in every way identical with the direct connection of the speaker in the plate circuit, as at a, and all the remarks made apply equally to these two arrangements. One simply assumes, in fact, that the speaker is to be connected directly in the anode circuit, and chooses the speaker (or the valve, as the case may be) on that assumption. This done, one adopts whichever one of the three circuits of Fig. 2 that happens to be the most convenient.

It is only when the choke is tapped, or the transformer has a ratio other than unity, that the mode of coupling the speaker to the valve calls for special attention. Where, either by transformer or tapped choke, there is a step-down of 2:1 we may regard the speaker as having four (two squared) times the impedance that it actually possesses. If the step is 3:1, then we are, in effect, multiplying the speaker impedance by nine (or three squared). An example will make clear how this is treated.

If, through difficulties of anode-current supply, we decide that we cannot use a valve of less than some 8,000 ohms A.C. resistance, then with the speaker of curve 6 we should have optimum power-transference at the frequency for which the speaker impedance is 16,000 ohms—that is, at a point about two notes below the highest note of the piano. The bass may therefore be expected

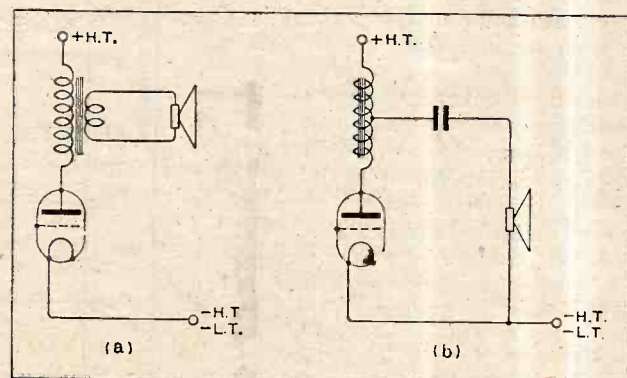

Fig. 3.—Either an output transformer with a ratio differing from unity, as at (a), or a tapped choke, as at (b), may be used as the correcting link between a valve and a speaker that do not suit one another. In either case the effect of the ratio is to increase the effective impedance of loud speaker and transformer taken together.

Matching Valve and Loud Speaker.—

to sound unpleasantly thin. But if we insert a 2 : 1 step-down transformer, or obtain a 2 : 1 step-down ratio by tapping the choke, as in Fig. 3, it will be equivalent to raising the effective impedance of the speaker four times at all points in the musical scale. As a result, maximum power transference will now take place at a frequency for which the speaker impedance is really only 4,000 ohms, but has been made equivalent to 16,000 ohms by the transformer. The frequency is little more than half an octave above Middle C, so that, with the transformer, the general level of music will be about right. A reversal of the argument will lead us to finding the transformer ratio required to fit any desired speaker to any valve.

The special case of loud speakers in series or parallel should, in the light of what has been said, present no difficulties, for all the speakers, taken together, make up the load in the plate circuit of the output valve. If we connect them in series the total impedance is the sum of their separate impedances, and the tendency will naturally be towards the accentuation of the lower notes. If optimum power is transferred to a 4,000-ohm load, then this load may be made up of will by one speaker or by several. For Curve 2, for example, this load is that of a single speaker at Middle C; if there are two in series they will each be given most power when their total load is the same, each therefore contributing 2,000 ohms. This they will do at about an octave and a half below Middle C, so that this will now be the centre of the most-favoured frequency band. In the particular case taken the drop in pitch will be the more noticeable, since a subsidiary band in the extreme treble will also be less marked.

If we connect them in parallel the total load will be half that of one speaker alone, and the band will now centre round about 700 cycles. The difference between the series and parallel connection is very noticeable, especially if a rapid change-over from the one to the other is made.

Making the Most of a Pentode.

The case of the pentode is a little different, and merits a few lines all to itself, though the same principles really apply. Broadly speaking, the triode supplies to the speaker a more or less constant voltage at all frequencies, even though the impedance of the speaker varies widely from one frequency to another. The pentode, on the other hand, tends to provide a constant current at all frequencies. Owing to this troublesome tendency, outrageously high voltages can be developed across a loud speaker at those frequencies for which its impedance is at its highest. On the other hand, the working impedance of the pentode is considerably higher than that of a triode of equivalent output power, so that an artificial raising of the speaker

impedance by means of a step-down transformer is often recommended for the sake of good reproduction of the lower notes. This, while shifting the frequency of maximum power-transference from the extreme treble down to a much more reasonable position on the frequency scale, accentuates the development of these excessive voltages.

Although these high voltages are not dangerous to the listener, they can be dangerous to the pentode, and, in addition, they tend very seriously to limit the output volume attainable by causing the pentode to overload on certain frequencies, and so to produce distortion when the average volume is still quite small.

The best solution of the difficulty that the writer has yet met is that used in the "Power Pentode Two" receiver described in the May 7th issue. Here the bass is looked after by a step-down ratio provided by a tapped choke acting as auto-transformer, while the upper frequencies are prevented from becoming unduly pronounced by a condenser and variable resistance connected in series and shunted across the "primary" of the choke (see Fig. 4). If a step-down transformer is used in place of the tapped choke these components must, of course, be placed across the primary if they are to retain the values given in the diagram; across the secondary a condenser of larger capacity and a resistance of lower value would be needed to produce the same results.

Tone Control Possible.

The variable resistance acts as an effective tone control, and by limiting the impedance of the plate circuit as a whole to its own value prevents the high voltages from making their appearance, and so not only safeguards the valve, but permits it to accept, without overloading, a grid swing that is so far increased that the total output from the valve is made noticeably greater. This effect, taken in conjunction with the improvement in quality that they bring about, amply repays one for the small additional expense of the added components.

THE SELENIUM VALVE.

A New Dry-plate Mains Rectifier.

IN the March issue of the German periodical called "Rafa" there is a description of an interesting new form of dry rectifier in which the usual active layer of copper oxide is replaced by a coating of selenium spread on nickel-plated iron discs. Lead sheet, backed with brass, is pressed against the selenium, a uniform pressure being obtained by the use of rubber separators.

The plates are grouped and connected so as to give full-wave rectification, with an output up to one ampere at about 4 volts. It is said that the rectifier is particularly suitable for combining with an electrolytic condenser for the direct supply of filaments, or it can be used for charging 4-volt batteries.

The device is a "Te-Ka-De" product manufactured by the South German Telephony Cable and Wire Works; they claim a special advantage in the positive temperature coefficient. During prolonged use and the consequent heating-up of the rectifier, the reverse current, instead of increasing, decreases. There is thus no fear of the rectifying action fading away.

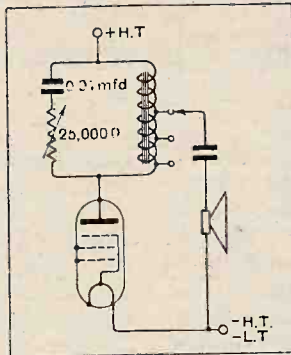

Fig. 4.—A satisfactory output circuit for a pentode. The tapped choke allows of good reproduction of the bass, while the condenser and variable resistance across the "primary" of the choke act as a control of the higher frequencies.

The First INDIRECTLY HEATED PENTODE

HITHERTO those who wished to avail themselves of the large output and high amplification of the pentode valve have been compelled, even if their receivers are driven from alternating current mains, to use an ordinary directly heated pentode. While the amount of hum introduced into the output of the set can be made quite small, as certain commercial receivers bear convincing witness, there is always a faint element of risk in applying raw A.C. to the filament of the pentode. Particularly is this the case when a moving-coil speaker is to be used, for this type of speaker is often highly sensitive to the 50-cycle or 100-cycle note derived from the mains. We are, therefore, very glad to welcome the first pentode to be equipped with an indirectly heated cathode by the use of which hum from the filament supply is rendered finally impossible. This valve is a member of the well-known series of Mazda indirectly heated valves, and is officially known as the AC/Pen.

Construction.

In overall size the valve is much about the same as the other mains valves produced by the same makers, but it differs radically from them in style of construction. In place of the characteristic "short-path" features, with all electrodes small and close together, the AC/Pen is built on positively spacious lines. The plate, which completely surrounds all the other electrodes, is a big cylinder, about seven-eighths of an inch in diameter, and an inch and a half in length. There is a wing on either side of the cylinder, from which run four heavy supports ending in a ring of metal clamped round the base of the pinch. This method of mounting the plate, although unusual, is not new; it has been used for transmitting valves and for valves designed to stand up to unusually high voltages.

The earthed grid, which is the next electrode in order, consists of a very open spiral of wire near, but by no means dangerously near, to the plate. It is connected within the valve to the cathode. The priming-grid, which is connected to a terminal on the side of the valve, as is usual with pentodes, is another spiral of



Characteristics of the Mazda
AC/Pen.

wire, of rather more turns to the inch than the last-mentioned. Within it in turn there is the signal grid, through which runs the coated tube containing the heater filament. The usual five-pin base provides for connection to the heater, the cathode, the signal grid, and the plate; all these are taken to the usual pins. The AC/Pen may thus be put into any set in place of an indirectly heated triode valve, the only alteration necessary being the provision of an extra wire

from the priming-grid (the terminal on the side of the valve base) to high tension positive.

Owing to the very generous spacing between the many electrodes, and to the fact that two strips of mica lock the upper end of the various supports firmly in their correct relative positions, it is practically impossible for any pair of electrodes to make illegal contact with one another.

The heater of the AC/Pen operates at the same voltage, and draws the same current, as other mains valves of the series, requiring one ampere at four volts. It is rated to withstand an anode voltage of 250, though the maximum permitted for the auxiliary grid is 200 volts. In the matter of voltage rating it thus falls into line with high-voltage pentodes of the battery-heated class.

Fig. 1 shows one of the many possible curves connecting grid voltages and anode current; it was taken with the auxiliary grid potential maintained constant at 200 volts, the rated maximum. It would have been quite possible to take a whole series of such curves, using a different auxiliary grid potential for each, but in the case of a valve so definitely designed for mains operation it is unlikely that any attempt will be made by any of its users to econo-

OWING to the remarkably large output that can be obtained with quite a modest input the pentode valve is gaining in popularity. Properly used, the quality of reproduction can be as good as that from a triode, but hitherto there has been a slight risk of hum when the filament is heated with raw A.C. We welcome the first example of an independently heated valve of this class, the characteristics of which are given in these notes. Supplies of the new AC/Pen. will not be available until July 1st next.

mise plate current, at the expense of output watts, by lowering this voltage. As is usual with pentodes, the curve shown may be regarded as representative of any anode voltage from the lowest that is likely to be used to the highest that the makers recommend, for the alteration of anode voltage makes almost no difference to the plate current. A change of anode voltage from 200 volts to 320 raised the plate current from 28 to only 29 milliamperes.

The First Indirectly Heated Pentode.—

The normal plate current under full-load conditions is some 25 to 30 milliamps., under which conditions the mutual conductance of the valve is seen, from Fig. 1, to amount to about 1.8 milliamperes per volt. This figure is high enough to ensure a good output of signals from quite a small input to the grid.

The Value of Anode Volts—Anode Current Curves.

A much more informative set of curves is shown in Fig. 2, where the relation between anode current and anode voltage, at a fixed auxiliary grid voltage of 200, is depicted.¹ Each curve refers to a different value of grid bias, the exact value being marked against each curve. The first information to be derived from Fig. 2 is the A.C. resistance of the valve; under working conditions it amounts to some 100,000 ohms. In conjunction with a mutual conductance of 1.8 this implies an amplification factor of 180, but it must be remembered that these figures are not to be construed in the same sense with a pentode as with a triode.

The optimum load resistance for a triode with an A.C. resistance of this order would be little short of quarter of a megohm; for the particular sample of the AC/Pen under discussion it has the value of some 10,000 to 11,000 ohms, as can be seen by the detailed consideration of the curves in the usual manner.² With this value of load resistance the available output approaches 1,500

milliwatts before distortion becomes appreciable. This figure represents a very large volume of sound; the average portable set can put out no more than about 300 milliwatts before overloading begins.

In the case of the present valve a grid bias of 10 volts is about suitable when the maximum high-tension voltages are applied. With the correct load in the plate circuit the curves of Fig. 2 can be utilised down to zero grid volts, while the grid circuit will also permit this as grid current does not begin to flow until the grid is made

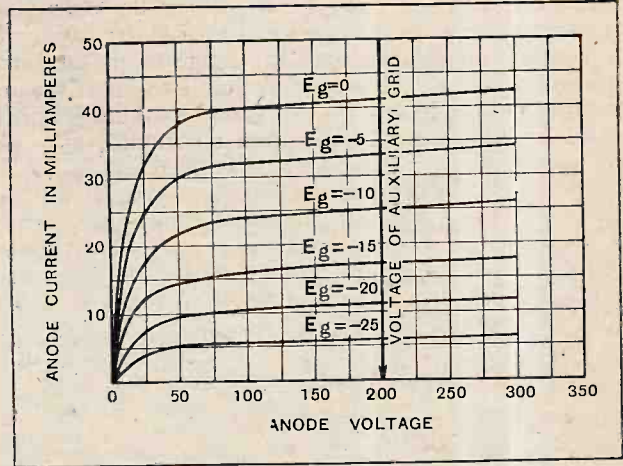

Fig. 2.—Anode volts—anode current curves of the AC/Pen. All curves refer to an auxiliary grid voltage of 200. An optimum load resistance of some 10,000 to 11,000 ohms is revealed by these curves.

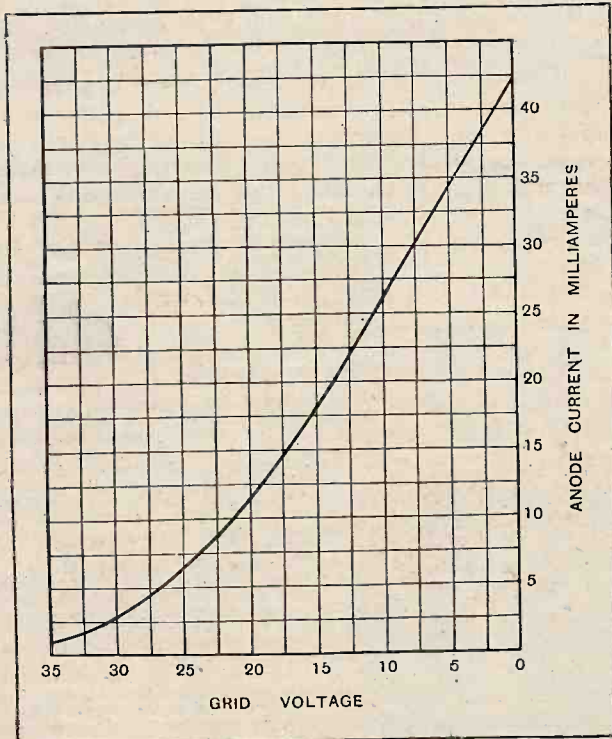

Fig. 1.—Grid volts—anode current curve of the AC/Pen. The curve refers to an auxiliary grid voltage of 200, and applies without appreciable change to any anode voltage from 150 upwards.

slightly positive. At zero grid volts the grid current observed was something under a quarter of a microampere.

Under normal running conditions, with 200 volts on the auxiliary grid, the current drawn by this grid was found to be 3.6 milliamperes. Where the full 250 volts is available for the anode circuit the decoupling arrangement shown in Fig. 3 will automatically ensure that the correct auxiliary grid voltage is applied. It must be pointed out that the use of a large condenser from auxiliary grid to cathode is absolutely essential whenever a voltage-dropping series resistance is inserted in the auxiliary grid lead. Without it, the valve will not function as a true pentode, and most of the special advantages derived from the formidable array of extra grids within the valve will be lost.

Pentode Correcting Devices.

Apart from this point the whole secret of obtaining satisfactory results from a pentode lies in the correct loading of the anode circuit. The use of a moving-armature type of loud speaker, without correcting devices of some kind, will never prove satisfactory, for the impedance of the loud speaker varies over an enormous range as the frequency of received music changes,³ becoming higher at the higher frequencies. This point is discussed elsewhere in this issue under the title, "Matching Valve and Loud Speaker," to which prospective users of this valve are referred. For the AC/

¹ "Grid Bias Values," by W. I. G. Page, *The Wireless World*, Dec. 18th, 1929, p. 666.

² "The Pentode Under Working Conditions," *The Wireless World*, Dec. 4th, 1929, p. 630.

³ "Tests on Cone Units," *The Wireless World*, Feb. 5th and 12th, 1930.

The First Indirectly Heated Pentode.—

Pen, suitable values for the correcting circuit are given beneath Fig. 3, and there need be no hesitation in adopting the correcting resistance and condenser, for they are recommended by the designer of the valve, and may therefore be taken as quite authoritative; furthermore, they gave entirely satisfactory results in "The Power Pentode Two" receiver recently described. Modifications in the actual values of resistance and condenser may, of course, be made to suit the taste of the listener and the peculiarities of the individual loud speaker. With the moving-coil speaker the correction is less necessary as the speaker has a closer approach to constant impedance over the range of musical frequencies. It is still, however, desirable to insert the resistance and condenser, the values suggested being 25,000 ohms for the resistance and from 0.001 mfd. upwards for the condenser. If the speaker is fitted with a "pentode coil," these components can go in parallel with it, the whole being fed with the usual choke-filter, but if a low-resistance speaker is used with a step-down transformer, the tone control circuit should be connected across the primary, and not across the secondary, where their effect would be negligibly small.

Alternatively, it is possible to redesign the cone of a moving-coil speaker, making it of quite soft paper to reduce the acoustic output of high notes. It must be borne in mind that the average speaker was designed when the old 2LO, which did not radiate high notes nearly as fully as does Brookmans Park, was still in operation, so that quite apart from any peculiarities of the pentode it is usual for speakers to give undue prominence to the high notes. There is, however, much

to be said for retaining the hard paper cone and using the accentuation of high notes as a set-off against the loss of side-bands due to too selective tuning on distant stations, only inserting the corrector of Fig. 3 when listening to the local station.

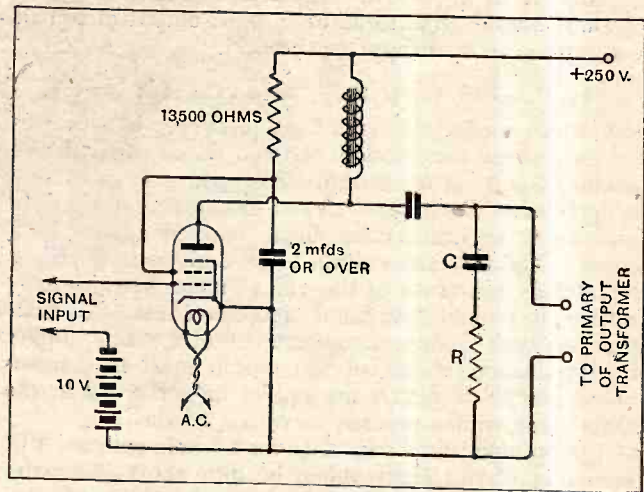

Fig. 3.—The corrector circuit made up of C and R is necessary with moving-armature loud speakers, and advisable even with a moving coil. For a moving-armature loud speaker C may have a value from 0.01 mfd. to 0.005 mfd. Smaller values, down to 0.001 mfd. will generally be preferred with a moving-coil speaker. 25,000 ohms is in all cases a suitable value for R; if desired, it may be made variable and then acts as a tone control.

If some small attention is paid to the points that have been mentioned, the AC/Pen will be found to provide its users with signals of high quality and generous volume.

Till September.

Captain Derek McCulloch, of the B.B.C., presided at the recent annual dinner of the South Croydon and District Radio Society. Music was supplied by the Technical Adviser of the Society, Mr. Remington, with his five-valve all-from-the-mains receiver and moving-coil loud speaker, and also by a member, Mr. R. A. Simmonds, who lent his gramophone with pick-up to be used with the amplifying stages of Mr. Remington's receiver.

The dinner concluded another session of the Society, and the gathering bade au revoir with the firm conviction that with the evening's enthusiasm as an example, they would meet again at the Surrey Drovers Hotel in September with increased vigour.

Hon. Secretary, Mr. E. L. Cumbers, 14, Campden Road, S. Croydon.

o o o o

All About Pick-ups.

Gramophone pick-ups were discussed by Mr. Youle, of the Marconiphone Co. at the last meeting of the North Middlesex Radio Society. The lecturer first gave a description of the principles on which a pick-up depends. Taking first the non-polarised form, Mr. Youle explained how distortion is produced owing to the non-linear pull of the magnet on the reed as the distance between magnet and reed varies. This source of distortion can be obviated by using a polarised instrument where the reed is balanced between the poles of the magnet. Using for illustration the magnetic pick-up manufactured by the Marconiphone Co., Mr. Youle described the design and construction of an efficient instrument where the characteristics were such as to counteract to some extent the faults of even modern gramophone records.

A very convincing demonstration followed the lecture, the apparatus used being a two-valve amplifier with 400 volts on the plate of the output valve. Quality was excellent and volume was such that the amplifier could seldom be used at more than half strength.

Hon. Secretary, Mr. E. H. Laister, "Wind flowers," Church Hill, N.21.

NEWS FROM THE CLUBS.

"Tinned Music."

This was the title of a lecture of exceptional interest given by Mr. K. Higginson, of Messrs. Varley (Oliver Pell Control, Ltd.) at the last meeting of Slade Radio (Birmingham). Commencing with the question of music on the talks, the lecturer gave frequency response curves and explained the acoustic laws governing satisfactory reproduction. Gramophone records and pick-ups were next dealt with and followed by the question of amplification. Special apparatus was demonstrated by means of which frequencies could be electrically suppressed and the effects shown in the reproduction. A number of records were played and first of all the high frequencies only reproduced, then the high suppressed, to be followed by bass only, high and low with middle suppressed, and then balanced reproduction. A special series of records was also provided which had the same effects mechanically reproduced. A four-valve amplifier was used with a moving-coil speaker. The volume was almost deafening but no distortion was perceptible, a tribute not only to the speaker but to the design of the amplifier.

Particulars of the Society may be obtained from the Hon. Secretary, 110, Hillaries Road, Gravelly Hill, Birmingham.

o o o o

Radio Maths Made Easy.

That the use of simple equations and graphs for solving problems and stating results of experimental work is not beyond the average wireless amateur was shown by Mr. R. M. Kay at a recent lecture before the Radio Experimenters' Society of Manchester

Starting at the simplest stage, the lecturer before the end of the evening had his audience working out problems which, they confessed, had previously baffled them, and recording results obtained from their researches in a form that made them easily grasped by others.

On Friday, May 23rd, the Technical Staff described in detail the construction of the new 41.5-metre telephony transmitter which has been evolved as a result of work on the present experimental "hay-wire, bread-board, hook-up."

Joint Hon. Secretaries, Mr. J. Levy, 19, Lansdowne Road, West Didsbury, Manchester; and Mr. R. M. Kay, B.Sc.Tech., 58, Daisy Bank Road, Victoria Park, Manchester.

o o o o

A Visit to the G.E.C. Laboratories.

Thanks to the good offices of Mr. F. E. Henderson, A.M.I.E.E., of the General Electric Co., Ltd.—a member of the Muswell Hill and District Radio Society—arrangements were made for a visit to the G.E.C. laboratories at North Wembley on May 17th. In addition to members of the Muswell Hill Society, representatives from the Tottenham, Golders Green and North Middlesex Societies were invited to join the party.

Sound film apparatus was first shown, including various amplifiers and light sensitive cells. Among the latter was one 18in. long—rather a contrast against some of the standard talkie cells. Following a constant frequency test of an M.C. speaker, the party adjourned for tea, which was prepared in an all-electric kitchen! Afterwards the company broke up into several small parties and visited the remainder of the laboratories. Among the many interesting things shown, the loud speaker test room should be mentioned. This room is completely blanketed to avoid all false resonances. Also of interest were the earthed screen rooms used for testing radio receivers on either broadcasting or specially modulated waves. Vacuum pumps and the life-testing room for valves and electric light bulbs were also seen, and a most enjoyable afternoon was terminated by an inspection of a wide range of bulbs of every size.

Hon. Secretary, Mr. C. J. Witt, 30, Coniston Road, N.10.

B 12

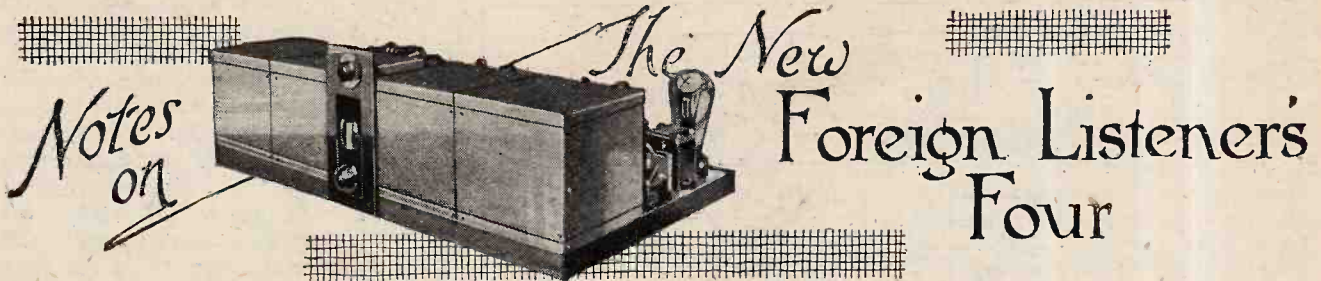

Problems Met With in the Design of "All A.C." Sets.

By F. H. HAYNES.

EVERY day since the introduction of the Foreign Listener's Four in last July has brought a batch of queries. While this indicates interest rather than difficulty, only a few of the queries have related specifically to the set as described, but refer to every possible modification, and in fact all the problems that could be encountered in the development of all-mains receivers. There has been little trouble when the receiver has been built up exactly to the details given, and in fact there is no outstanding form of query of common interest.

The importance of obtaining correct screen potentials is worthy of mention, and if too low in value the range of reception will be impaired, and if too high the receiver may oscillate. By the use of screen potentiometers discrepancies have been largely avoided, but where there is any doubt as to the range-getting properties of the receiver it is worth while connecting a resistance of some 1,000 ohms in each screen lead and connecting to an H.T. battery, the negative terminal of which joins to the screening boxes. In making this test the leads to the ends of the potentiometers should remain connected, as it is mainly the current which is passed by the potentiometers that produces the biasing potentials. If improvement results, then the correct tapping point on the potentiometers must be estimated in a like ratio as that existing between this determined voltage and the maximum voltage (280 volts). A reduction of 10 per cent. in the positive section of the potentiometer, with a consequent increase in the section in the negative side, roughly compensates for the addition of the screen current. Anode potential of the H.F. valves is fortunately not critical, and as the anode current passed by these valves varies considerably in different specimens the potential obtained as the result of the voltage-dropping resistances is likely to be far from correct. Check the anode current with a

low-reading milliammeter. Values between 1.3 and 2.8 mA. in respect of the M.S.4 valves can be tolerated.

Gramophone Pick-up.

Provision was not made for the use of a gramophone pick-up owing to the fact that only a single L.F. stage followed the detector and many pick-ups require a three-stage amplifier. Entirely satisfactory results can be obtained, however, with those pick-ups giving a generous voltage output.¹ A two-way low-capacity switch is connected in the grid circuit of the detector valve to switch over to the pick-up, and a small negative bias is taken from the biasing resistance of the H.F. stages. Consequently it is necessary to keep the H.F. valve running when using the pick-up, but if much gramophone reproduction is contemplated it would be worth while to use a three-pole switch so that the heater circuits to the two H.F. valves are broken, while an additional resistance of 60,000 to 70,000 ohms becomes connected from the common positive to the earth of the screening boxes.

Alternative Valves.

In interchanging the H.F. valves for those of alternative type which may be to hand care must be

¹ Voltage outputs of gramophone pick-ups were given in the article "Gramophone Pick-ups Tested." *The Wireless World*, 26th March and 2nd April, 1930.

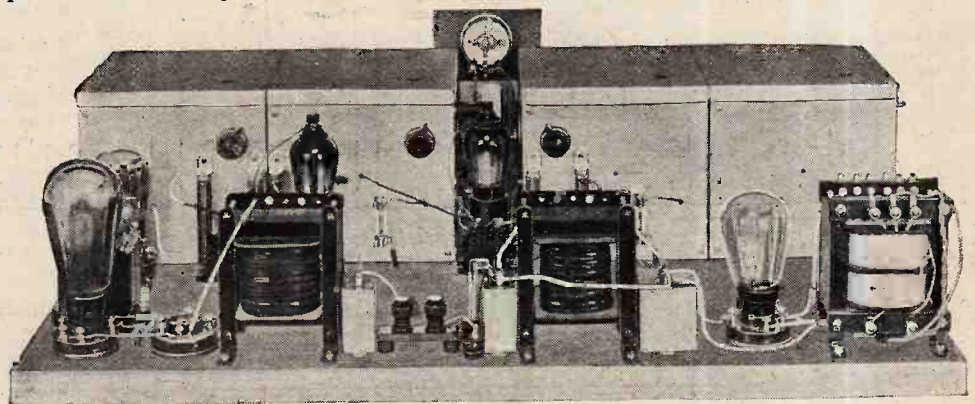

Modifications to the layout include the combining of the wave change switch with the coil so that smaller screening boxes can be used and the depth of the baseboard increased in order to accommodate the H.F. chokes, condensers and resistances on the underside.

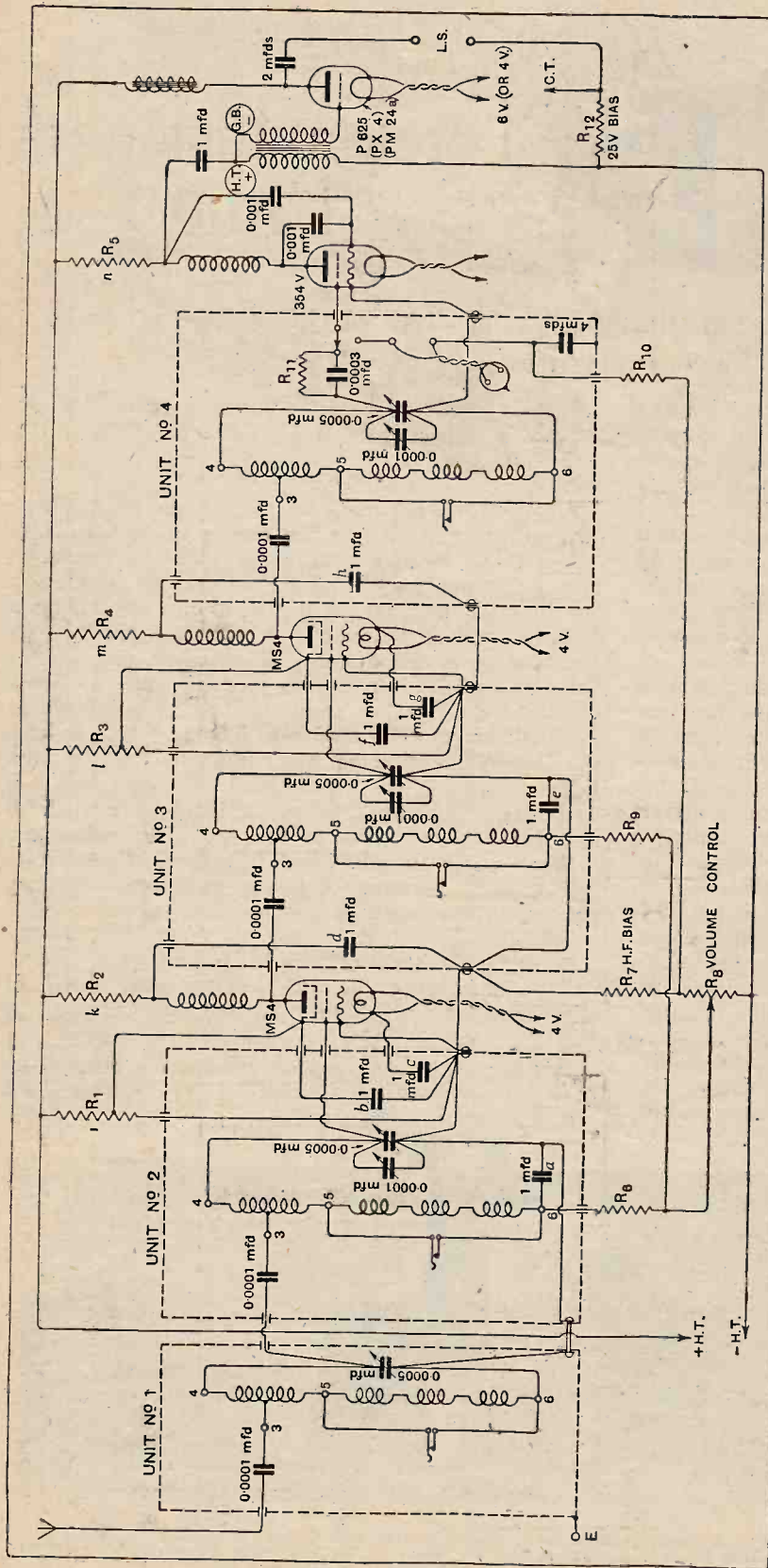

To introduce the gramophone pick-up a low-capacity switch is connected in the grid circuit of the detector. If power grid detection is attempted with leak and condenser of 0.25 megohm and 0.0001 mfd. a potential of 150 volts must be applied at the anode of an AC/HL detector valve while additional precautions are necessary to avoid L.F. oscillation.

taken to ensure that the correct anode screen and biasing potentials are applied. In using A.C./S.G. valves, for example, in place of the M.S.4 type anode and screen voltages of 150 and 60 are required. These values are produced with sufficient accuracy by the use of voltage-dropping resistances of 35,000 in the anode circuits and screen potentiometers of 80,000 ohms tapped at 20,000 ohms, as originally specified. A small increase in the H.F. bias is desirable, and is obtained by using a 200-ohm biasing resistance (R_7) in place of the 120 ohms as used with the M.S.4 valves. With A.C./S.G. valves the tapping point in the middle of the broadcast band coil remains satisfactory, but the receiver will oscillate when switched over to long waves. Practice has shown that the best thing to do, therefore, is that of reversing the leads connecting to terminals 4 and 6 on the coil bases so that the long-wave section is now on the grid side of the tuned circuit. Test shows that this in no way impairs reception on the broadcast band, while more than six stations can be received with certainty on the long wave in spite of the unsatisfactory condition whereby only one-eighth part of the tuned circuit is tapped off by the anode lead.

The values for S.4V. valves are: Anode resistances, 100,000 ohms; potentiometers, 80,000 ohms, tapped at 30,000 ohms.

Mention might be made here of the mistake in building this receiver with only a single H.F. stage and expecting long-range reception. Probably no other receiver will bring in more distant stations, assuming the use of two H.F. stages, but on reducing the receiver to a three-valve arrangement the regenerative conditions in the tuned circuits disappear. As a three-valve set detector reaction must be introduced.

Anode-bend Detection.

For various reasons there has been desire to modify the detector. If anode-bend detection is substituted the filter unit becomes superfluous even when the receiver is operated near a high-power station. This statement is made in spite of the fact that a strong signal

Notes on the New Foreign Listener's Four.—

overloads the H.F. valves and renders the H.F. stages unselective. Anode-bend detection brings fading into evidence with distant-station reception, owing to the fact that sensitivity becomes less as the signal weakens. This is a reverse state of affairs to those existing with the leaky-grid detector, which tend to correct the fading and give a constant signal with a varying input. With the anode-bend detector and L.F. stage unaltered reception becomes high-pitched, and it is therefore necessary to follow the detector by a resistance coupling of low stage gain and making up for a loss of signal strength on the distant stations by the use of an additional L.F. stage.

Three H.F. Stages.

In many cases an additional H.F. stage has been added to compensate for the reduced results obtained by the anode-bend detector operating with a small input. No difficulty is met with as regards instability, while the mains transformer is capable of delivering the increased output without modification. With a stage gain of, say, 30 times there is not much advantage in grading the H.F. valves by increasing the screen and grid voltages of successive stages so that they may handle an increasing signal. A weak signal, but capable, after amplification, of giving full loud speaker strength is obtained without overloading the third H.F. valve, and in the case of strong signals the volume control, which is arranged to increase the negative bias on the H.F. valves, will be brought into operation. Many H.F. valves give grid current when the grid becomes less than about 0.7 volts negative. On the other hand, to bias the grid back to more than -2 volts reduces amplification. In using such valves there is insufficient separation between the stations owing to the flow of grid current producing a condition that

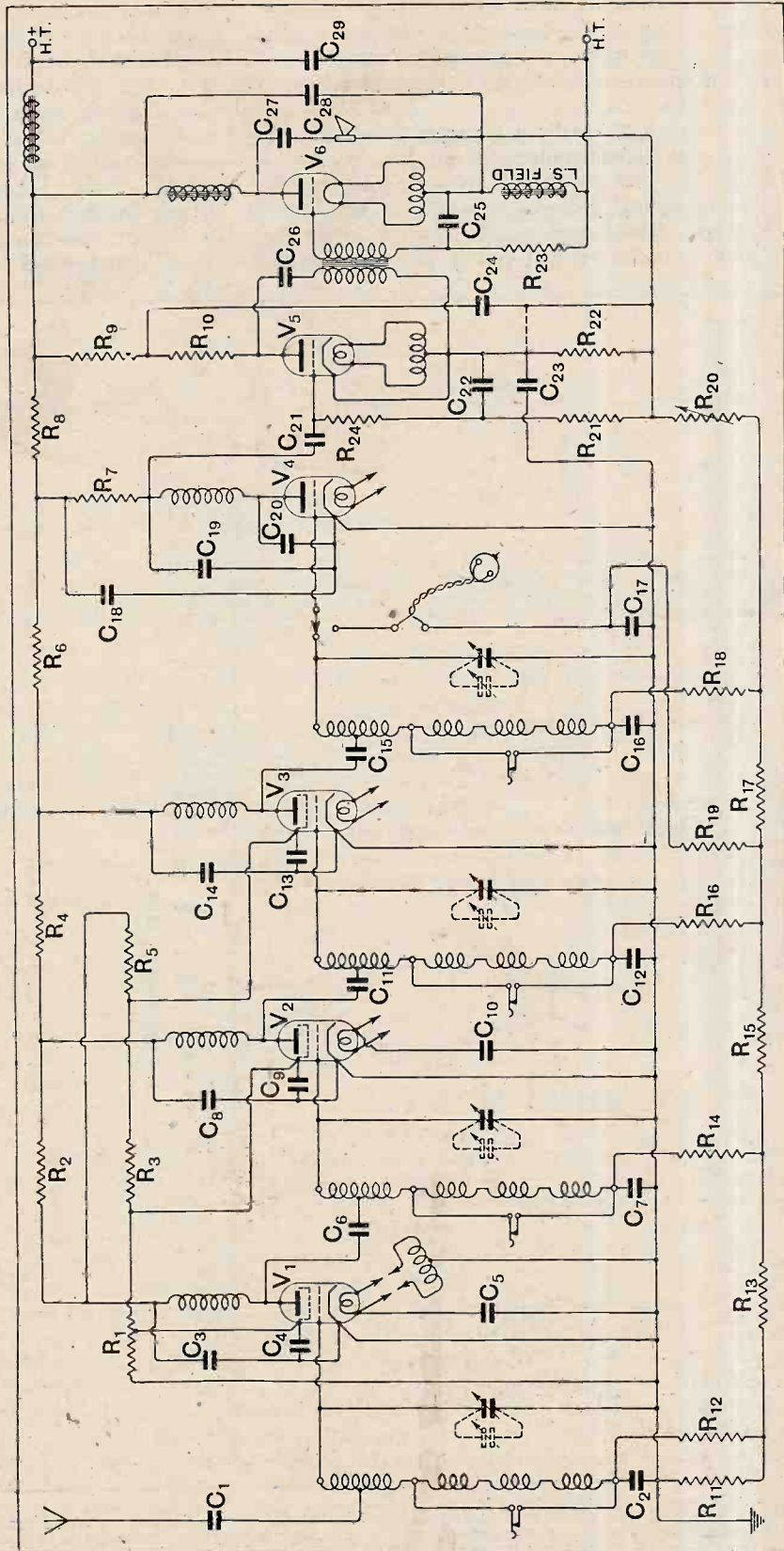

Elaborated circuit sought after by many readers and constituting a long range selective set. The rectifier circuit, using a U-8 valve, and the associated transformer windings are omitted. C₁, C₃, C₁₁, C₁₅, 0.0002 mfd.; C₂, C₄, C₆, C₇, C₈, C₉, C₁₀, C₁₂, C₁₃, C₁₄, C₁₆, C₁₇, 1 mfd.; C₁₈, C₁₉, C₂₀, C₂₁, 0.0002 mfd.; C₂₂, 0.05 mfd.; C₁₈, C₂₂, C₂₃, C₂₄, C₂₅, C₂₆, C₂₇, C₂₈, 2 mfd.; C₂₉, 4 mfd. If the tuning condensers are of the straight line capacity type, trimmers are unnecessary.

Notes on the New Foreign Listener's Four.—

flattens the tuning. Over-biasing, on the other hand, gives rise to rectification, and the detected signal tends to produce a condition similar to flatness of tuning by modulating other carriers.

To avoid the use of three separate potentiometers for feeding the screen potentials advantage may be taken of the fact that the three valves may be operated with different screen voltages, so that in tapping off along a single potentiometer sufficient resistance may be included between each tapping point to provide

sufficient decoupling between the stages. This brings us to the three H.F.-valve circuit followed by an anode-bend detector and two L.F. stages, and we are faced with the problem of devising a group of potential dividing resistances to give the necessary anode, screen and biasing values. As the current taken by the several valves fed from this potentiometer system totals about 10 mA., the resistance of the potentiometer should be such that it passes about 20 mA. in addition to the current taken by the valves.

Without the aid of a ready calculator the determina-

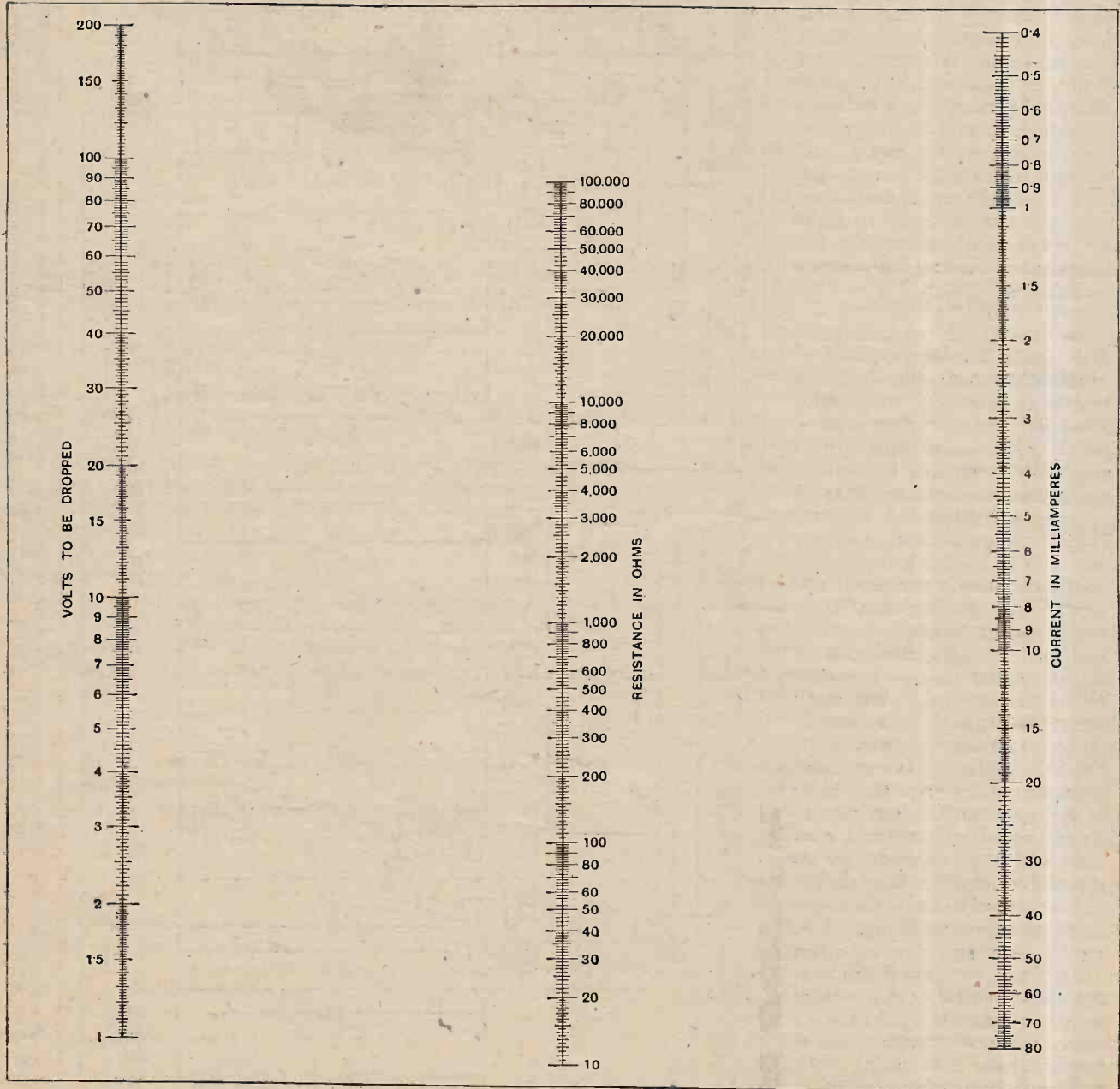

This chart simplifies the process of determining the values of the resistances required for reducing the potentials in the anode circuits and creating the biasing potentials. A straight edge joining the "voltage to be dropped" and "current passed" values reveals the resistance required on the centre scale of ohms. For higher values of voltage take one tenth and multiply the resistance given by ten. In taking higher current values, divide the resistance given by ten.

Notes on the New Foreign Listener's Four.—
 tion of the various resistance values is wearisome, and an "abac" is given covering the range of voltage, resistance and current values met with. Thus the resistance R_8 will pass the current required by valves V_1, V_2, V_3 and V_4 , plus 20 mA. Assuming the maximum voltage is 500, and 150 is required at the anode of V_4 , while there is a potential drop of 50 volts through R_7 , 160 in the two smoothing chokes and 15 in the biasing resistances, we see that 175 volts have already been lost and that a potential of 200 is wanted at the junction of R_6 and R_8 . This demands

threshold condition of regeneration, will be met with unless effective decoupling is employed in the L.F. stages. While the grid circuit of the output valve is decoupled from its anode by the 0.25-megohm resistance R_{23} and the 4-mfd. condenser C_{25} decoupling is required in both the grid and anode circuits of V_5 . This valve is biased by the resistance R_{22} and the grid circuit decoupled by the resistance R_{21} and condenser C_{22} . The feed resistance R_{10} has a value of about 10,000 ohms, and R_9 both regulates the anode potential and serves for decoupling. Although it would seem correct to connect the earth side of C_{24} to the valve cathode, as

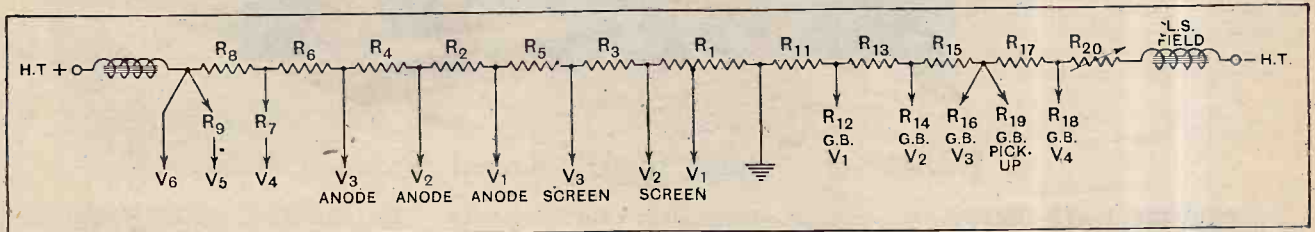

The voltage regulating resistances for three H.F. stages, anode bend detector and pick-up and two L.F. stages as used in the circuit diagram shown on page 557. Resistance values are more readily determined when the circuit is set out in this way. An alternative position for the volume control is on the earth side of R_{11} so that amplification is reduced by increasing the bias applied to the H.F. and detector valves.

that 125 volts must be dropped in R_8 , when a current equal to all that taken by all the potentiometer-fed valves, plus 20 mA., is flowing. The valve currents are found from valve data tables and, knowing the total current and the voltage to be dropped, the resistance of R_8 read off. If a higher potential is wanted on V_3 than V_4 , then a separate potentiometer circuit must be used to feed V_4 .

Complete L.F. Decoupling Essential.

In calculating the value of R_6 we take the fall in voltage between that produced at the R_6 - R_8 junction and that required at V_3 , and assuming a current of 20 mA. plus that passed by the anodes and screens of V_1, V_2 and V_3 . This is probably the simplest method of arriving at the values of all the resistances, and assuming the use of Mazda S.G. valves, it is quite easy to provide for anode voltages of 200, 180 and 160 on the V_3, V_2 and V_1 and next successive screen potentials of 80, 70 and 60 volts. Biasing resistance values are readily determined from the "abac" by taking the total current passed on the milliamperes scale and the successive biasing grid potentials required (for the screen voltages chosen) on the volts to be dropped scale. R_{12}, R_{14}, R_{16} and R_{18} are not, of course, wire-wound and, being used for decoupling, have a value of about 0.25 megohm.

One form of volume control is shown consisting of a variable resistance R_{20} , the effect of which is to drop all screen and anode potentials. Owing to the high-value resistance required and the heavy current carried a more convenient method is probably that of connecting a wire-wound resistance of about 1,000 ohms between R_{11} and earth. This resistance will cause an increase in the bias on the four valves.

"Motor-boating," when the H.F. stages are in a

shown by the dotted line, practice reveals that it is better joined to the H.T. negative lead.

It is to be noted that the bias for the output valve is obtained across the resistance of a smoothing choke, which is itself the field winding of a moving-coil loud speaker. Assuming that V_6 is a valve of the L.S.6A. type, requiring a bias of 90 volts, while the total current passed is of the order of 90 mA., it will be seen that the loud speaker field may have a resistance of about 1,000 ohms. This represents a normal loud speaker winding when the gap is of the usual area and is not more than $\frac{1}{16}$ in. in width. As much as 8 watts is available, and "free loud speaker energy" is now obtained in addition to free grid bias, both being incidental to smoothing. This method operates with entire freedom from hum.

Complexity of Mains Sets.

The circuit arrangement, though being complicated, is not very difficult of interpretation into practical form provided all the resistance values are calculated with care according to the valves chosen, while screening must be complete, particularly as regards the need for covering the S.G. valves in metal tubes and the grid and anode wires running to them. All resistances and condensers should bear reference numbers on circuit and set and their pairs of terminals spotted with red and blue paint as an aid to identification.

The vogue of A.C. mains-operated sets using many and generous valves with one-dial operation and other complications such as, for example, automatic volume control and flat-topped resonance are being produced by enthusiastic readers, and these notes are based upon experiences met with in the laborious task of making up apparatus in order to cover some of the ground from a practical standpoint.

Wireless World LABORATORY TESTS

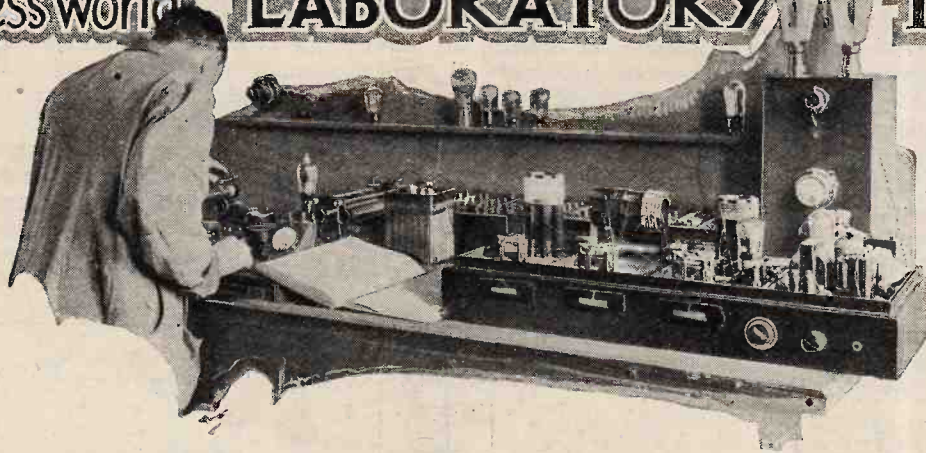

A Review of Manufacturers' Recent Products.

BROWNIE WAVE-TRAP.

The full designation of this device is a wave-trap and selectivity unit, which implies that it can be used either to enhance the overall selectivity of a set or to reject a troublesome interference in the shape of a powerful local programme. Listeners residing in the London area, who are unable to receive either one of the Brookmans Park transmissions without a background from the other, will find this unit, used as a wave-trap, an effective and simple remedy. Elsewhere it may be found that its best application is that of a separately tuned aerial circuit. Local conditions must be left to decide its mode of use.

On test we found it singularly effective as a rejector when used in conjunction with a simple set which could not separate the two programmes under normal conditions. The wipe-out area introduced covered a waveband of from 410 to 460 metres when the unit was adjusted to reject the London Regional programme.

The device consists of a moulded bakelite container, in which are housed two

cylindrical coils, tightly coupled together, and a small variable condenser. One coil is tapped at intervals to provide a variable aerial coupling while the other is tuned by the condenser. The ends, and the tappings of the aerial coil, are brought out to sockets marked 1 to 4 inclusive, and the ends of the tuned coil terminate at the sockets marked 5 and 6. By externally connecting these sockets as explained in the instructional leaflet, the device becomes a rejector or a selectivity unit as desired.

The makers are the Brownie Wireless Co., of Great Britain, Ltd., Nelson Street Works, Mornington Crescent, London, N.W.1, and the price is 10s. 6d.

o o o o

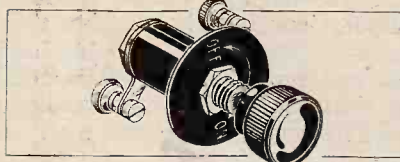

Omega L.T. battery switch.

OMEGA BATTERY SWITCH.

The body of this switch consists of a short ebonite barrel closed at one end by a screw plug and at the other end by a bush which is threaded both inside and out. A short length of screwed rod, to which is fixed the control knob, screws into the bush and makes contact with the back plug.

The two connections are taken from the plug and the bush respectively. Although there is no wiping action to maintain a clean contact, the pressure between the screw and the fixed plug is such that any dirt will be ground away and a certain metal-to-metal contact will result.

A feature of special interest to some is that the screw contact piece can be completely removed thereby preventing any unauthorised person from using the set in the owner's absence. A single hole suffices for fixing purposes.

The makers are the Earl Engineering and Electrical Co., 132a, Much Park Street, Coventry, and the price is 2s.

o o o o

RECTIFIER UNIT FOR B.T.H. R-K SPEAKERS.

Users of the well-known B.T.H. R-K loud speakers who have hitherto drawn the field current from D.C. mains and are now faced with a change-over to A.C., will be interested to learn that a rectifier unit is available at the price of £4 4s. This consists of a transformer, a smoothing condenser, and a full-wave rectifying valve, type UU60/250, enclosed in a well-ventilated metal case.

A sample was tested on a 240-volt 50-cycle supply, and the D.C. output measured under load. With 40 milliamps drawn from the unit, the D.C. voltage was 200 and with 60 milliamps, 172 volts. This is marketed by the Edison Swan Electric Co., Ltd., 1a, Newman Street, London, W.1.



By interconnecting the sockets, the Brownie wave-trap can be converted into a selectivity unit.



Rectifying unit for field excitation of R-K loud speakers from A.C. mains.

MAGNUM "DISSOLVER" AND A NEW WIRE-WOUND POTENTIOMETER.

The "Dissolver" is a potentiometer device which has been designed especially for use in radio-gramophone sets to provide a more gentle change-over from a wireless programme to the gramophone,



A rocking disc, actuated by a rotating arm, minimises wear on the resistance element in the "Magnum" dissolver.

or vice versa, than can be achieved with switches. By its aid broadcast signals can be gradually faded out and the gramophone slowly brought up to full strength. It functions, also, as a combined volume control. Actually the device is a high-resistance potentiometer, but with the addition of a connection to the centre of the resistance element. The moving contact does not ride over the resistance, but as it rotates it presses a rocking disc on to the track. Since contact is made by pressure there can be little or no wear on the resistance element, so that it should remain constant in use. The sample tested was found to have a total resistance of 1.2 megohms, one half accounting for 537,500 ohms and the other 562,500 ohms. The price is 10s.

A new "Magnum" component is a wire-wound potentiometer, in which the moving contact takes the same form as that described above. In this case, however, resistance wire is wound spirally on a core of very small diameter and laid in



"Magnum" wire-wound potentiometer, in which the moving contact takes the form of a rocking disc.

a groove cut in the ebonite disc which forms the body of the component. The absence of a direct rubbing contact presupposes perfect silence in action, and this assumption was substantiated by a practical test on an early sample.

B 19

The values of these resistances range from 25,000 to 50,000 ohms, and the price in each case is 7s. 6d.

The makers are Messrs. Burne-Jones & Co., Ltd., "Magnum House," 296, Borough High Street, London, S.E.1

5-FOOT EXPONENTIAL HORN.

The requirements of a good loud speaker horn are two-fold: first, it should be so shaped that it causes the maximum air pressure to be exerted on the diaphragm;

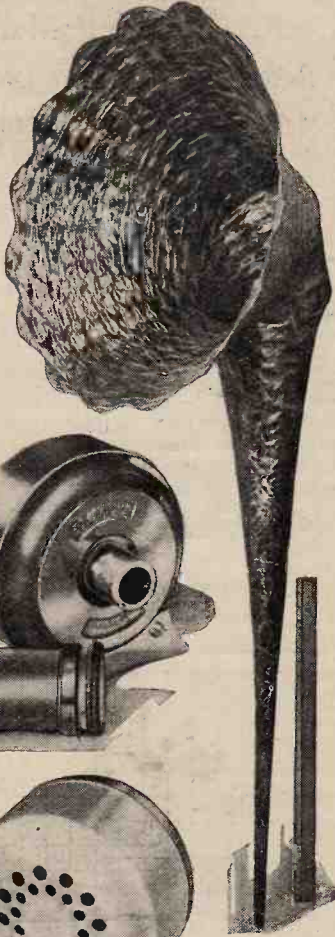

Exponential horn by the Scientific Supply Stores, together with the Brown and Baldwin Units. The size of the horn can be gauged by comparison with the 2 ft. rule.

and secondly, the mouth should be large to avoid noticeable horn resonances. These features are exhibited in the 5ft. exponential horn made by the Scientific Supply Stores, 126, Newington Causeway, London, S.E.1. The model illustrated has the flair turned at right angles to the main part of the horn so that it can be stood in a convenient corner of the room. The diameter of the mouth is 25in., and the cross-sectional area of the horn doubles every 6 inches throughout its length. The cut-off frequency is thus about 128 cycles.

When used with the Brown Type U unit—one of the two units recommended by the makers—there was a slight falling-off in the reproduction of the upper register, but this was noticed only on orchestral music, and speech was clear and crisp. The middle register and the bass were well brought out. With the Baldwin balanced armature unit a better level was obtained, and the higher tones were more in evidence. These tests were made using an output valve of 1,750 ohms impedance, which, no doubt, was on the low side for the Brown unit. A valve of higher A.C. resistance would probably have given a better showing in this particular case. It was used because a large power output was desired to test for power-handling qualities. The combination was found to be very sensitive, and even with a small output valve gave good volume.

The price of the horn with the Brown unit is £2 18s. 6d., and with the Baldwin unit £2.

o o o o

"ATLAS" 50-HENRY CHOKE.

Made by Messrs. H. Clark and Co. (Manchester), Ltd., Atlas Works, Old Trafford, Manchester, this L.F. choke is intended for use in smoothing circuits and such other cases where the maximum D.C. current does not exceed 50 milliamps. We found that the ohmic resistance of the winding was 2,570 ohms, and it will be necessary to make allowance for this, as a rather high voltage will be absorbed by the choke when passing large currents. When carrying the maximum value of 50 mA. the volts dropped across the choke will be of the order of 128. Consequently we regard its usefulness as being restricted to cases where the D.C. flowing does not exceed 10 milliamps.



Clark's Atlas 50-henry L.F. choke.

Some measurements were made of its inductance at 50 cycles, and, with 4 milliamps of D.C. flowing, a value of 187 henrys was recorded. With 10 milliamps this dropped to 94 henrys and with 20 mA. passing through the choke the inductance was 48 henrys. The price of the choke is 25s. and it is housed in a metal case finished in olive-green.

WIRELESS THEORY SIMPLIFIED

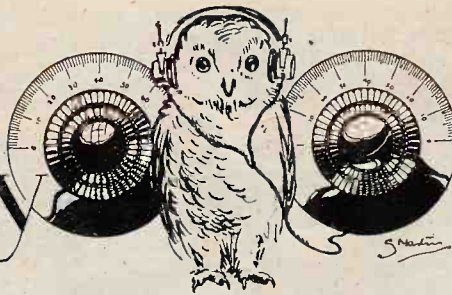

By S. O. PEARSON,
B.Sc., A.M.I.E.E.

Part XXXI.—Reception of Modulated Waves.

(Continued from page 518 of issue dated May 14th.)

THE effect of a tuned high-frequency circuit on a modulated wave will now be considered from the point of view of the sideband theory. We are not concerned with the nature of the waves in space passing between the transmitting aerial and the receiving aerial, but with the behaviour of tuned circuits when modulated waves are being received. Whatever the nature of the ether waves, we do know that the voltage induced into the receiving aerial is one which follows faithfully the variations of current in the transmitting aerial to which the receiver is tuned, provided there is no interference.

Suppose that a circuit is tuned to a wavelength of 300 metres, or a frequency of 1,000 kilocycles per second. Assuming that the coil inductance is 200 microhenrys, the tuning-condenser capacity will then have to be 0.0001266 mfd., found by calculation from the formula $\lambda = 1885 \sqrt{LC}$, or from tables.

Assuming, further, that the effective high-frequency resistance of the circuit is 10 ohms, the selectivity number calculated on a 10 per cent. basis will be

$$\frac{1}{5R} \sqrt{\frac{L}{C}} = 24.6$$

approximately. This is the ratio of the resonant frequency to the change in frequency required to reduce the signal strength to 10 per cent. of its maximum value, as explained in Part XV. Thus, if F is the change in frequency from the resonant value,

$$\text{we have in this case } \frac{10^6}{F} =$$

24.6, or $F = 40,700$ cycles per second. Hence, for a frequency of 40.7 kilocycles per second above or below the frequency to which the circuit is tuned, the signal strength will be only 10 per cent. of what it would be if the frequency were equal to the resonant value.

Plotting the Peak of a Resonance Curve.

The resonance curve for this particular coil and condenser is given in Fig. 1. It is plotted to a frequency base scaled in kilocycles per second above and below the

resonant frequency, which is 1,000 kilocycles per second. Thus each frequency is referred to as being so many kilocycles per second above or below the resonant value or so many kilocycles "off tune." If f_0 is the resonant frequency and f any other frequency in cycles per second, then the number of cycles per second off tune is given by $F = f - f_0$, and for frequencies near the resonant value

the current is given by $I = \frac{E}{\sqrt{R^2 + (4\pi FL)^2}}$ ampere very approximately where E is the applied voltage. This is a most useful formula for finding the shape of the resonance curve near the peak, the part which concerns us most. It is assumed that the resistance of the circuit remains constant over the band of frequencies near resonance.

[Note that in this particular formula we have $4\pi FL$ and not $2\pi FL$.]

At the resonant frequency the current would be simply

$$I_m = \frac{E}{R} \text{ ampere, and therefore}$$

the ratio of the current at a frequency slightly off resonance by F cycles per second, to the maximum value at resonance, is

$$\frac{I}{I_m} = \frac{R}{\sqrt{R^2 + (4\pi FL)^2}}$$

Now, in view of the fact that a modulated high-frequency wave can be treated as the sum of a central carrier wave, and a number of pairs of auxiliary waves occupying a band of frequencies on either side of the carrier frequency, we can, with the aid of the resonance curve, determine exactly what attenuation is produced on each of the low-frequency components of the modulation.

Single-frequency Modulation.

Taking the simplest case first, we shall assume that the high-frequency voltage applied to the tuned circuit is modulated at an audio-frequency of 5,000 cycles per second. This wave can be resolved into three component high-frequency waves of constant amplitude, one having

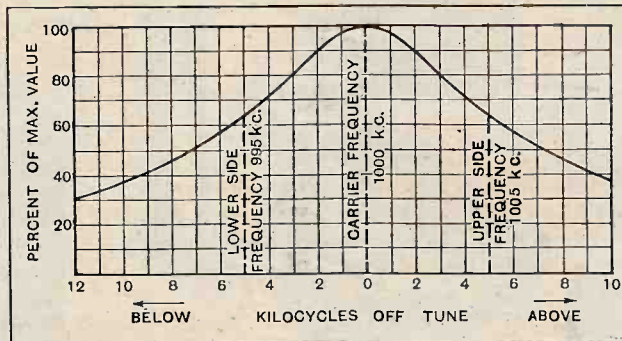

Fig. 1.—Resonance curve for a tuned circuit in which $L = 200$ microhenrys, $C = 127$ micromicrofarads, and $R = 10$ ohms. When a 1,000 Kc wave modulated at a frequency of 5 Kc is applied to this circuit, the corresponding side-frequencies of the resulting current wave are reduced in amplitude to 62.5 per cent. of the value required for ideal reproduction.

Wireless Theory Simplified.—

a frequency of 1,000,000 cycles per second, being the carrier frequency, and the other two having frequencies 5,000 cycles per second higher and 5,000 cycles per second lower respectively than that of the carrier wave, these being the component side-frequencies corresponding to the modulated wave.

Thus by assuming that these three component voltages are being applied separately to the tuned circuit we can read off from the resonance curve of Fig. 1 the values of the corresponding high-frequency currents flowing round the circuit, these values being expressed, as a matter of convenience, as percentages of the maximum value obtained at the resonant frequency.

In this particular case the two side-frequencies are 5 kilocycles per second off tune, the positions relative to the curve being indicated by the vertical broken lines, and the percentage value of each of the side-frequency currents is seen to be 62.5, being a reduction of 37.5 per cent. compared with the current at the carrier frequency for the same value of applied voltage.

Now, although we have made use of the component frequencies for purposes of calculation, we actually know that the three component currents in the tuned circuit are combined in the form of a modulated high-frequency wave of current.

There cannot be more than one current flowing through a single circuit, any more than there can be two streams of water flowing through the same hose-pipe. But the amplitude of the side-frequency components relative to the carrier-frequency component has been reduced by 37.5 per cent. in the current wave compared with the relative values of the corresponding components of the applied voltage wave. This means that the tuned circuit has the effect, for a modulation frequency of 5 kilocycles per second, of weakening or attenuating the modulation of the current in it to 62.5 per cent. of the modulation of the applied voltage. For instance, if the applied voltage wave is modulated to a depth of 50 per cent. the current wave will be modulated to 62.5 per cent. of 50 per cent.—that is, to 31.2 per cent. only, when the modulation frequency is 5,000 cycles per second. The voltage and current waves representing these conditions are shown in Fig. 2.

Relative Amplitudes of Side-frequencies.

An inspection of the resonance curve of Fig. 1 shows clearly that there is very little weakening of the modula-

tion for frequencies up to 1,000 cycles per second. In the circuit chosen, the attenuation at a modulation frequency of 1,000 cycles per second is only about 3 per cent., but for audio-frequencies above this value the modulations of the high-frequency current begin to fall off rapidly.

In the accompanying table the degree of modulation of the high-frequency current in the tuned circuit is given for various audio-frequencies, being expressed in each case as a percentage of the value it should

have for theoretically perfect reproduction. The figures in the second column apply to the 10-ohm circuit previously referred to, and those in the third column to a 5-ohm circuit having the same tuning constants, namely $L = 200$ microhenrys, and $C = 0.0001266$ mfd. It should be realised that the percentages given in the table do not represent a comparison of signal strengths for the two circuits at any given modulation frequency, but merely indicate for each circuit the relative amplitudes at the various frequencies of modulation.

A high-frequency wave, which is modulated by a complex low-frequency wave, resolves into a central wave having the carrier frequency and a number of pairs of waves with corresponding frequencies on either side of the carrier frequency. From the table

below it will be clear that the higher note-frequency variations of the current in the tuned circuit, and the voltage built up across it, will be reproduced at a strength considerably lower than those of the lowest frequency, and for this reason the true quality of the note will be lost. The note of a violin, for instance, will be lacking in overtones to an extent depending upon

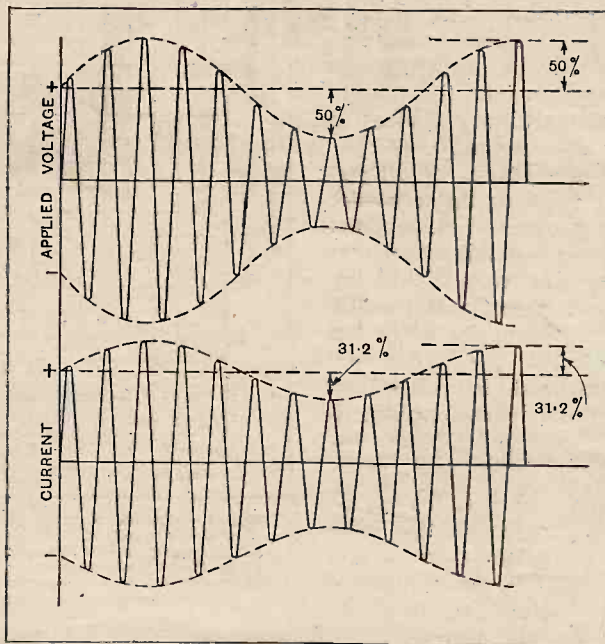

Fig. 2.—When a 300-metre wave modulated to a depth of 50 per cent. is applied to a tuned circuit having an inductance value of 200 microhenrys and a resistance of 10 ohms, the resulting current oscillations are found to be modulated to a depth of 31.2 per cent. only, when the modulation frequency is 5 Kc.

Modulation Frequency. (cycles/sec.).	Per Cent. of Maximum.	
	R = 10 ohms.	R = 5 ohms.
0	100	100
500	99.2	96.9
1,000	97.1	89.4
2,000	89.3	70.3
3,000	80.0	55.2
5,000	62.5	35.4
8,000	44.8	24.1
10,000	37.0	19.5

Table showing the relative weakening of the higher note frequencies by tuned circuits having resistances of 10 ohms and 5 ohms respectively. In each case $L = 200$ microhenrys and $C = 126.6$ micromicrofarads.

Wireless Theory Simplified.—

the sharpness of the resonance curve, this, in turn, depending chiefly on the high-frequency resistance of the tuned circuit.

Effect of Increasing the Selectivity.

A comparison of the second and third columns of the table given might at first give the impression that, when the "efficiency" of the tuned circuit is increased by decreasing its effective resistance, the higher modulation frequencies are actually weakened; but this is not the case—it is the lowest frequencies which have been *strengthened* by the reduction in circuit resistance. This is very clearly shown by Fig. 3, in which the resonance curves have been drawn for both the 10-ohm and 5-ohm circuits to the same arbitrary scale, the applied voltage being the same in each case.

It should be noted that the amplitudes of all frequencies have been increased by reducing the resistance of the circuit from 10 ohms to 5 ohms; but, whereas the amplitudes of frequencies several kilocycles per second off resonance have been only very slightly increased, those near resonance have been greatly magnified in comparison. The carrier frequency wave has actually had its amplitude doubled.

The voltage magnification of a tuned circuit has been referred to in connection with unmodulated waves, its value being $m = \frac{1}{R} \sqrt{\frac{L}{C}}$. Now, in dealing with modulated waves it will be appreciated that it is the carrier frequency component only which undergoes this magnification.

The side-frequency components are magnified to a smaller extent, depending on the number of kilocycles per second off tune. However, they are magnified, and not weakened, by the tuned circuit. So, when we replace an inefficient tuning coil in a receiving set by a more efficient one, we increase the selectivity and also the average signal strength; but the lower modulation frequencies are the ones which are increased in amplitude most, and if the tuning coil is made too efficient it may be that the lower frequencies will be accentuated to such an extent compared with the higher ones that the reproduction from the loud speaker becomes "woolly"; the sibilants and aspirants of speech are omitted, and reed and string instruments in music seem to be devoid of their overtones or higher harmonics on which their particular quality depends, and sometimes there is a booming effect.

From the foregoing it is clear that for tuned circuits

of the ordinary kind, and where the detector is followed by a low-frequency amplifier which gives sensibly equal amplification of all audio-frequencies, selectivity is gained only at the expense of quality. But the figures in the preceding table and the resonance curves plotted to a linear scale as shown make matters appear to be much worse than they really are as regards actual hear-

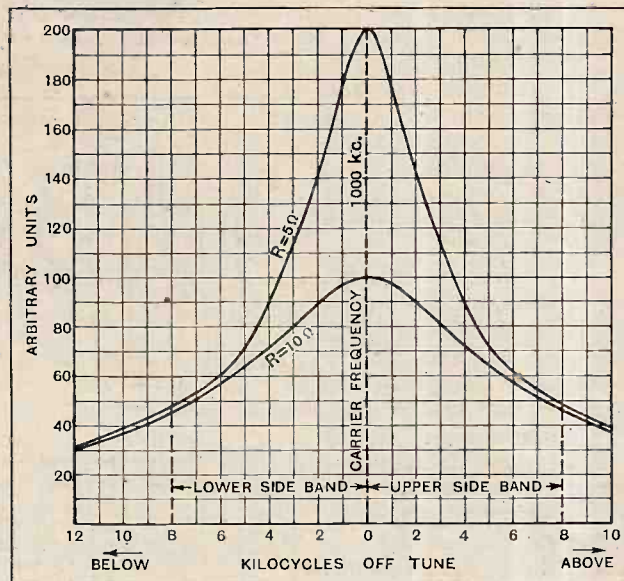

Fig. 3.—Resonance curves for a tuned circuit in which L=200 microhenrys and C=127 micromicrofarads, drawn for resistance values of 10 ohms and 5 ohms respectively. The curves show that a reduction of resistance produces a large increase in the amplitudes of the lower side-frequencies but very little increase for the higher frequencies.

ing, because the human ear is very insensitive to relative changes in the amplitudes of the component frequencies in the middle and upper registers of the musical scale. For instance, if the amplitude of one of the higher frequency components is reduced by as much as 20 or 30 per cent., this attenuation is hardly noticeable.

When extreme selectivity is necessary, it becomes essential to introduce special methods for suppressing the excessive strength of the lower notes. This can be done in the high-frequency portion of the receiver by employing coupled filter circuits, or in the low-frequency amplifier by the introduction of a special filter circuit or tone control.

(To be continued.)

Electrical Wiring and Contracting. Vol. IV. Edited by H. Marryat, M.I.E.E., M.I.Mech.E. Comprising: Motor Starters and Regulators, Private Power Plant, Electric Signs and Estimating, the sections being written respectively by H. Cotton, G. A. Wedge, and H. R. Taunton. Published by Sir Isaac Pitman and Sons, Ltd., London. Price 6s. net.

A First Electrical Theory for Schools by H. W. Heckstall-Smith, M.A. A text-book covering the School Certificate, Matriculation and 1st M.B. Examina-

BOOKS RECEIVED.

tions, including Electrostatics, Electromagnetism, Electrolysis, Dynamos and Motors, Discharge Tubes, Valves, X-rays, Radioactivity, etc. Pp. 372, with 135 illustrations and diagrams. Published by J. M. Dent and Sons, Ltd., London and Toronto, price 4s. net.

New Piezo Oscillations With Quartz Cylinders Cut Along the Optical Axis. By A. Hund and R. B. Wright. (Bureau

of Standards, Research Paper No. 156.) Pp. 12, with 23 plates, price 20 cents.

A 12-Course Radio Range for Guiding Aircraft with Tuned Reed Visual Indication. By H. Diamond and F. G. Kear. (Bureau of Standards, Research Paper No. 154.) Pp. 19, with 22 illustrations and diagrams, including 3 half-tone plates, price 10 cents.

Engine-Ignition Shielding for Radio Reception in Aircraft. By H. Diamond and F. G. Gardner. (Bureau of Standards, Research Paper No. 158.) Pp. 10, with 22 illustrations and diagrams, including 10 half-tone plates, price 15 cents.

SAYING IT WITH STAMPS.

The cancellation stamps in use at a number of German post offices now bear the exhortation "Werdet Rundfunkteilnehmer!" i.e., "Become a broadcast participator!"

MODERNISING WEA F.

The deepest bass notes as well as the clear tones of the high notes are promised to New York listeners in the near future by engineers of the National Broadcasting Company as a result of a permit obtained from the Federal Radio Commission to re-equip the famous station, WEA F. The transmitting power is 25 kW., and no increase has been sanctioned.

STATION DETECTION MADE EASY.

Illicit transmitters in Paris have a new risk to face in the shape of a secret wireless network recently set up by the police. According to our Paris correspondent, three directional receiving stations have been erected outside the capital at points forming an invisible equilateral triangle. When illegal signals are suspected their exact source can be discovered in a very short time. The ultimate "capture" is effected by policemen armed with directional portable sets.

HISTORIC GEAR ON VIEW.

Historic wireless apparatus, including an original Fleming two electrode valve, forms part of a window display now attracting great interest at Marconi House, Strand. Another exhibit comprises the actual aircraft transmitter, receiver and direction finder which secured the rescue of Captain Courtney and his companions when their flying boat caught fire in mid-Atlantic.

In contrast with the Fleming valve are three modern transmitting valves, one of the water-cooled type.

BAIRD TELEVISION AMALGAMATION.

In the Chancery Division on May 19th Mr. Justice Eve sanctioned amalgamation schemes between the Baird Television Development Company, Ltd., and Baird International Television, Ltd. The Development Company transfers all its property and liabilities to the International Company, fully paid shares in the latter being given to shareholders of the Development Company. It was stated that the International Company still had a cash capital of £170,000.

TRANSATLANTIC AFTER-DINNER SPEECH.

Speaking from Cambridge on May 21st, Sir Ernest Rutherford, president of the Royal Society, addressed a banquet of the Canadian Royal Society in Montreal. The speech was conveyed by telephone to the Marconi beam station at Bodmin, whence it was transmitted to the Canadian Marconi Company's station at Yamachiche, Quebec, and relayed to the banquet hall.

BIG BUSINESS IN ATLANTIC CITY.

The "World's Largest Auditorium," Atlantic City, N.J., is to be the venue from June 2nd to 6th of the Fourth Annual Trade Show of the American Radio Manufacturers' Association. Concurrently with the show the Institute of

Current
Topics

Events of the Week
in Brief Review.

Radio Engineers will hold their annual meeting in Atlantic City. The feature on June 4th will be "the largest radio industry banquet ever held."

INVENTORS, FORWARD!

The Sixth International Exhibition of Inventions will be held from October 1st to 11th next at the Central Hall, Westminster, S.W.1.

SUMMER EVENING LECTURES.

Lectures on the electrical reproduction of sound are included in the syllabus of summer evening classes at the Manchester Municipal College of Technology. A full prospectus of the courses, which begin on June 16th, can be obtained on application to the registrar.

THE BUG-KILLING TEST.

Claiming that they can eradicate bugs and other insects from apple orchards by means of low-frequency radio waves, a group of engineers in East Wenatchee, Washington, has been granted a three months' transmitting licence by the U.S. Federal Radio Commission. In the tests now in progress, radio waves of a low frequency are sent through the apple orchards every morning between 4 and 7 o'clock,

says the *New York World*, the wavelength being about 3,000 metres on a power of 10 kilowatts.

The Radio Commission has expressed doubt as to the efficacy of the experiment.

A WIRELESS FILM.

Useful hints on the care and manipulation of wireless sets are given in a cinematograph film entitled "Radio Record," which has been produced by Messrs. Ensign, Ltd., for the benefit of radio societies and lecture groups. The film deals with the products of the leading wireless manufacturers.

Secretaries of societies who have not already arranged for the display of this film during the coming autumn should communicate at once with Messrs. Ensign, Ltd., 40, Shaftesbury Avenue, London, W.1. The company provides the necessary projection equipment and a qualified operator.

DESPERATE REMEDIES.

"Why not adopt a radio cushion?" is the suggestion of a contributor to the correspondence columns of *The Times*, in a letter on the subject of noisy loud speakers. He contends that a radio cushion (by which, we presume, he means a cushion containing a telephone ear-piece) would be more comfortable than headphones, and would also avoid disturbance to other people. He adds: "A law prohibiting the use of loud speakers should be passed by Parliament without delay."

Why only loud speakers? Why not abolish motor cars, railways, ships, roads, the correspondence columns of newspapers, etc., etc.?

EXPERIMENTER'S TELEVISION CLAIM.

Mr. Tom Payne, of Gallowgate, Newcastle-upon-Tyne, writes to us claiming to be the first experimenter in the North to pick up a foreign television transmission. Mr. Payne accidentally picked up the television signal of Berlin (Witzleben) at 1.5 a.m. on May 17th, and was later successful in tuning in the "picture," which showed a human face giving signs of movement. Synchronisation was somewhat difficult.



A RADIO RESEARCH 'PLANE. Mr. Vincent Z. de Ferranti, chairman of the company bearing his name, photographed in the cockpit of the Ferranti aeroplane, which is used for radio research work and is believed to be the only machine so employed in this country.

New Gear at Tatsfield.

Readers who have ever repented inviting friends "to come and listen to distant stations," finding too late that conditions were unfavourable, must have sympathised with the B.B.C. engineers at Tatsfield when they tried last week to give us the speech of Mr. Hard, the American journalist, direct from New York. "Stars and Stripes" was the title, but the talk was mostly "Whistles and X's."

○○○○

Minus the Spaced Aerials.

Better things are hoped for on June 4th, when Tatsfield will make another attempt with apparatus formerly in use at the Marconi Company's receiving station at Terling, near Chelmsford, and used in conjunction with the spaced aerial system. There is no room at Tatsfield for a similar aerial arrangement, but the B.B.C. engineers intend to do their best with the two short-wave sets and other gear which arrived from Terling early last week.

○○○○

Next Relay Attempt.

The talk on June 4th will be given by Ruth Hanna McCormick, who hopes soon to represent Illinois in the American Senate and thus become America's first woman Senator. She is supposed to be a trenchant critic of Britain, so it will be a pity if we don't hear her.

○○○○

News Experiment Ends.

The experimental Empire news service from 5SW has now terminated, and nothing is likely to be known of the impression it has created until the delegates meet at the Imperial Conference next month. This eleventh-hour test was arranged in order that Dominion listeners would be able to judge an Empire transmission from what, after all, must be its most important aspect.

○○○○

Now or Never?

Empire broadcasting is an important item on the agenda of the forthcoming meetings, and a definite decision for or against the service is practically certain before the delegates return home.

I have heard rumours that a new short-wave station might be erected at Tatsfield.

○○○○

Early to Bed in the Provinces.

On Mondays, Wednesdays, and Fridays the provincial stations of the B.B.C. close down at 11 p.m., while London and Daventry listeners can enjoy transmissions till midnight. The surprising point is that only a few Northern listeners have thought it worth while to protest. Is all Manchester in bed at 11 o'clock?

○○○○

Lewis to Produce German Play.

"The Twelve Thousand," a German play by Bruno Franck, will be produced by Cecil Lewis at Savoy Hill in July. Another play for broadcast during that month is Anstey's "The Brass Bottle."



By Our Special Correspondent.

The Ulster T.T.

Broadcasts at regular intervals will take place on August 23rd in connection with the Ulster T.T. Motor Race on the Ards circuit.

○○○○

"Missing from His Home . . ."

SOS calls dealing with cases of illness are much more successful than those concerning persons missing from their homes. During the first three months of this year forty-seven of the eighty-one calls for relatives of sick folk were successful, but only ten missing persons were traced out of a total of fifty-two appealed for. I think more lost people would be found if

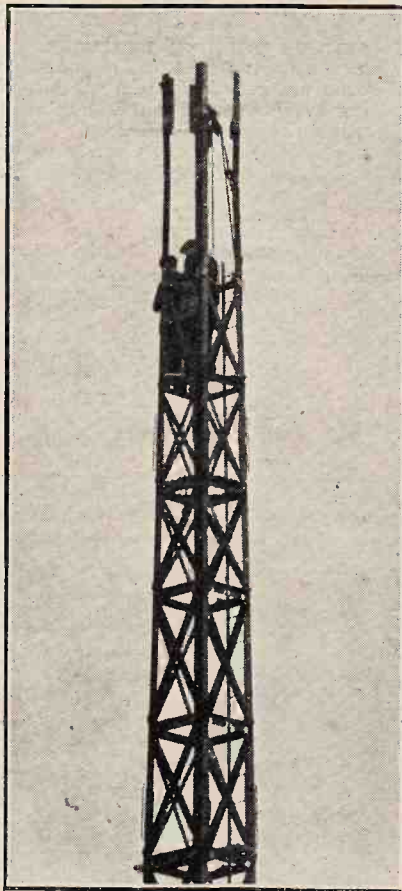

A VANISHING LANDMARK. Workmen dismantling one of the 2LO masts in Oxford Street, which have been sold to a crane manufacturer.

the broadcast descriptions were less vague. Brown overcoats and striped shirts are as common as house sparrows, yet we are quite often asked to trace persons with no other information than the alleged peculiarities of their clothes.

The moral, I suppose, is that only people with scars, limps, or squints should get lost.

○○○○

The Bagpipes Explained.

Mr. Seton Gordon, the well-known Scottish writer is an expert on the more recondite branches of the art of piping. It is on this subject that he is to speak on the occasion of his broadcast on June 10th. This time Mr. Gordon will not be speaking for Scottish listeners only, but for the National programme. He is to have the assistance, as illustrator, of Pipe-Major Robert Reid, of Glasgow.

○○○○

The Time Seller.

Selling "time on the air" is a fascinating business, to judge from the enthusiasm of the American National Broadcasting Company's sales manager, Mr. E. P. H. James, now visiting this country. Mr. James told me last week that no less than 60 per cent. of the company's transmitting time is now occupied by "sponsored" programmes; the remaining 40 per cent. is retained in order that the company may balance the entertainment side with news, educational talks, religious services, and other items which do not lend themselves to trade publicity.

○○○○

Programmes for Every Product.

The utmost care is taken to ensure that every advertiser gets the maximum value from his "Hour," which is staged at a time when the greatest number of potential purchasers are likely to be listening. A trained staff gives special attention to the "tone" of the programme; these experts see that a perfume manufacturer, for example, is represented by a programme of the highest refinement, and that a sparking-plug concern offers nothing that is not snappy and sparkling.

○○○○

What a Dollar Will Do.

Descending from the sublime to the dollar, Mr. James mentioned that each advertiser reaches 1,000 sets for every dollar he spends in radio advertising. This is the formula on which the publicity schemes are based, and, to prevent any diminution in the number, N.B.C. officials actually visit the homes of listeners to discover what types of programmes have the greater appeal.

One can imagine a B.B.C. official on such an errand, such is the power of the human imagination.

○○○○

What Did He Mean?

I asked Mr. James his opinion of the B.B.C. programmes. He said that if American listeners were to be taxed on the same lines as listeners over here, the programmes they are getting would be worth £2 15s. per annum.

I thought that was enough for one interview.

Pioneer Work in Signal Measurement

It is just a quarter of a century since the first wireless experiments were carried out to find how the signals from a transmitting station fall off in strength as the distance between the sender and receiver is increased. These were carried out by W. Duddell and J. E. Taylor, at the instance and under the control of the Engineer-in-Chief of the British Post Office, and an account of them was published in the journal of the Institution of Electrical Engineers for July, 1905. To the modern wireless reader who is fully acquainted with electrical units such as microfarads and microvolts per metre, etc., the reading of this old paper is likely to prove an interesting and delightful experience. There he will find an aerial referred to as an "air wire," wavelengths always expressed in feet, and capacities given in terms of "pint jars." But the fundamental results described in this now classical paper are positively amazing, and answer all kinds of questions that the average broadcast listener is always asking to-day.

In 1904 Duddell had described a new type of galvanometer known as the thermo-galvanometer, and it was this instrument that made the measurement of wireless signals possible, for it was both sensitive and suitable for high-frequency current work. To measure received signal currents the galvanometer was actually connected in series with the receiving "air wire" or aerial. In the instruments used the current passed through a small heater of about 100 ohms, and the heat developed affected a small thermocoupler which was attached to the moving part of the galvanometer. The sensitivity of the thermo-galvanometer could be varied by varying the distance between the heater and the thermo-junction.

Spark signals had, of course, to be used, for it was before the days of continuous-wave working and the three-electrode valve. One of the first problems tackled was that of finding out how the received signal varied with the height of the receiving aerial. The receiving circuit was retuned to suit each height of vertical wire by altering the "self-induction," or, as we should now say, the "inductance," in series with it. The current in the "receiver air wire" was found to be approximately proportional to the vertical height of the wire,

"Air Wire" Tests of Twenty-five Years Ago.



The late W. Duddell, F.R.S.

IN 1905 a stir was created in electrical circles by the success of experiments in the measurement of wireless signal strength, made possible by the invention of the Duddell thermo-galvanometer. The tests, conducted by W. Duddell and J. E. Taylor under the auspices of the Post Office, were chronicled in a now classical paper published by the Institution of Electrical Engineers. Some delightful extracts are given in the accompanying article.

a result which is, of course, nowadays taken as almost axiomatic. In this section of their work Duddell and Taylor got some results from which they concluded that "to obtain the sharpest tuning the stay wires of wireless telegraphy masts should be well divided up into short insulated sections to avoid the production of oscillations in them which would cause damping in the receiver." This is a point that is, of course, well recognised nowadays, but it is of interest to note the first mention of it.

There must be many listeners of to-day who have exercised their minds as to whether the particular direction of the horizontal portion of their receiving aerial produced any directional effect in reception. It is now well known that the long Beverage antenna has pronounced directional characteristics, and the question is whether any such properties are retained when the horizontal portion is only of a length comparable with the height. Duddell and Taylor do not appear to have made experiments on a receiving aerial with a rotating horizontal portion, but they did experiment with a transmitting aerial the horizontal portion of which could be altered, and found that the particular direction of this part of the aerial did not affect the signal strength received at short distances to any great extent, and we may expect aerials to be similarly effective for both reception and transmission. In other words, it is the height, and not the direction, of the aerial that chiefly matters for both transmission and reception.

In experiments carried out in Bushey Park, Duddell and Taylor made the first quantitative study of the

variation of signal strength with distance for overland transmission, and we find a very interesting section of their paper, headed rather quaintly, as follows:—

"Distance between Transmitter and Receiver Varied.

Receiver near Fish Ponds.

Height of Receiver Air Wire, 56 feet.

Height of Transmitter Air Wire, 42 feet.

Spark gap, 7.08 mm.

Mercury Interruptor.

Wave-Length, 400 feet."

In these experiments it was found that the signal intensity fell off slightly more rapidly with increase of

Pioneer Work in Signal Measurement.—

distance than is predicted by the simple theoretical inverse distance law which is valid only for a perfectly conducting earth. The shielding effect of obstacles such as large trees was noted, as well as the improvement in signal that is noticed when either the transmitter or receiver is brought out into the open again after being in the shadow of an obstacle, even though the distance is actually increased.

In an appendix to the paper the authors give what is, from the scientific point of view, perhaps the most important result in the paper. This is the relation between the signal strength and distance for oversea transmission obtained during a series of experiments between H.M. telegraph ship *Monarch* and a receiving station alongside the Martello tower at Howth, in Ireland. The first series of experiments was carried out with the *Monarch* approaching Howth from Scotland on her journey south down the Irish Sea. Measurements began at a distance of 37 miles. The second and third series of measurements were carried out while the *Monarch* made a special trip for the purpose from Howth to Holyhead and back. All three tests prove that "for fairly long distances the current in the receiver air wire is almost exactly inversely proportional to the distance between the transmitter and receiver." Duddell and Taylor were therefore the first to demonstrate experimentally the fundamental law of wireless transmission for oversea transmission, and also to show that on land the attenuation is appreciably greater than oversea.

An attempt was made, while the *Monarch* remained at anchor in Kingstown Harbour, to determine the difference in strength of signals received during the daytime and

at night. No difference was observable which could be traced to greater absorption during daylight, although their observations were correct to 1 per cent. We therefore see that the distance was too short for night effects, due to the Heaviside Layer, to be appreciable, and in the interesting discussion which followed the reading of the paper the Engineer-in-Chief of the Post Office, Mr. J. Gavay, mentioned, as a valuable subject for further investigation, the determination of the distance at which the difference between day and night signals which had been discovered by Marconi first became pronounced. Nowadays we should call this the distance at which fading begins.

Another item of the discussion was a characteristic communication from Dr. J. A. (now Sir Ambrose) Fleming, who vigorously took the authors to task for speaking of a capacity as "one 4-pint jar half covered with tinfoil" and of an inductance coil as being of so many turns of certain sizes and wires, and described such language as being that met with in the catalogue of an instrument maker and, as such, out of place in quantitative scientific work. Evidently the day of the microfarad and the microhenry was just dawning. But such criticisms, though probably justified, did not invalidate the chief results of the paper, which was the relation between signal strength and distance oversea and overland.

The senior partner in this famous collaboration, Mr. Duddell, died some time ago, but Mr. Taylor is still a vigorous student of wireless subjects, and in the discussions before the Wireless Section of the Institution of Electrical Engineers often plays the rôle of a "die-hard" who sees no necessity whatever for worrying about a Heaviside Layer!

RADIO SOCIETIES VISIT THE G.E.C. LABORATORIES.

The upper photograph gives a general view of the G.E.C. laboratories at Wembley; in the lower picture is shown the valve and photo cell development section, which was inspected by members of London radio societies on May 17th.

A VISIT to the Research Laboratories of the General Electric Company at Wembley always interests wireless enthusiasts, and on Saturday, May 17th, the equipment was inspected by members of the Muswell Hill, Golders Green, North Middlesex, City and Guilds, and Tottenham Wireless Societies. The visitors were able to examine the equipment used in the design of valves and photo cells as well as general investigation work in connection with the lamp industry. Of outstanding interest was the department devoted to the accurate investigation of loud speaker performance.



CORRESPONDENCE

The Editor does not hold himself responsible for the opinions of his correspondents.

Correspondence should be addressed to the Editor, "The Wireless World," Dorset House, Tudor Street, E.C.4, and must be accompanied by the writer's name and address.

NEW MOVING COIL LOUD SPEAKER.

Sir,—The letter from Dr. McLachlan in your issue of May 14th seems to invite a reply; in part this reply can await the technical article which is expected shortly to appear in *Experimental Wireless*, and which deals with some of the theoretical and experimental work done by Capt. B. S. Cohen and myself on the Balsa Piston Moving-coil Speaker (a brief account of this instrument in your issue of April 9th having formed the source of Dr. McLachlan's information). In the interests of the art, however, one or two of his comments may, with your permission, be dealt with briefly.

He refers to a demonstration in which the speaker was fed from a gramophone pick-up; the measured characteristic of the latter has a peak between 4,000 and 5,200 p.p.s., which partly accounts for his verdict that the upper register was too prominent. The outstanding feature of our instrument is its efficiency up to 7,000 p.p.s., which results in a clearness and naturalness of speech reproduction hitherto unattained in any hornless loud speaker, when used in broadcast reception, but somewhat degraded under the conditions of the demonstration referred to. A simple hearing will, I feel sure, convince the writer of the letter of these facts; I should be delighted to afford him the opportunity. I think that he would admit the inadvisability of pronouncing judgment, under the first-named conditions, on the results of a long series of careful experiments except after careful investigation.

The pronounced resonance, usually at about 2,000 p.p.s., associated with instruments of the cone type is absent, and the response down to 50 p.p.s. is good as measured on the calibrated electrostatic microphone; no trace of boom can be detected. But I am very ready to admit that, in spite of extreme clarity, the tonal balance of the combination heard by Dr. McLachlan could be improved upon and, in fact, the older instruments to be mentioned in our forthcoming article gave a greater proportion of output at the lower frequencies. Given an amplifier designed for the instrument under consideration, its tone can be lowered; other hearers do not generally desire this.

A glance at the article commented upon will make it plain that we did not contemplate that the velocity of sound in Balsa, along the grain, is the same as the velocity to be considered in a diaphragm; the former velocity was stated as a result of the high ratio between elasticity (or strength) and density, a matter vitally affecting the choice of material.

ROBT. W. PAUL.

London, W.14.

DAVENTRY 5XX.

Sir,—Mr. C. E. Wood's remarks on 5XX are very true; there is no doubt that the quality is bad, and, in my opinion, the quality of the other stations is nothing to shout about so long as they will use a "blanketed" studio. Contrast the transmission from Eastbourne, with the ordinary studio programme, and the difference is amazing, the latter being natural. Mr. Wood is quite right in implying that the long-wave station is the most use to the majority of people, and I contend that three long-wave stations, one in London, one Midland, and one North, each giving its own programme, would provide the whole of the British Isles with three alternative programmes. In my opinion the lower the wave the less its general usefulness.

WILFRID SHARPE.

Arnside, Westmorland.

Sir,—The letter under above heading in your issue of April 30th was long overdue. The difference in quality between the transmissions from 5XX and Brookmans Park is distressingly obvious even on a reed-driven cone fed from a 2-volt power valve with about 400 milliwatts undistorted output. I consider

the modification of 5XX, in the light of recent experience with Brookmans Park, an increase in its power, and the construction of a specially designed land line from London to Daventry 5XX to be far more urgent than the completion of the regional scheme. To listen to 5XX is painful after hearing modern gramophone records reproduced by means of a good pick-up.

The Rectory, Larne,
N. Ireland.

J. PATRIC L. STEVENSON.

VALVE LEGS.

Sir,—I see in a German radio paper that the Standardisation Committee of the Central Union of German Electro-Technical Industries has decided that from January 1st, 1931, valve legs shall not be fitted with any form of spring leg. The springing must be done by the socket in future. This is said to be in the interests of economy and mass-production.

H. E. A.

BROOKMANS PARK IN ALASKA.

Sir,—We cannot allow the report of reception of Brookmans Park in Alaska, referred to on page 341 (March 26th) of "Broadcast Brevities," to be claimed as a record.

We, here in Lahore, and several of our customers have many times tuned in 2LO (356 metres) just after Bombay has closed down (5.30 p.m. G.M.T.). One night the volume was overpowering and a volume control had to be used.

The programme consisted of the last portion of the Children's Hour, Big Ben struck six o'clock, a talk on Dickens ("Great Expectations"), criticism of six new plays, besides news, market prices and musical interlude.

The sets used were our own design, consisting of S.G., leaky grid detector, with reaction to the parallel feed tuned anode, two L.F. (transformer coupled) stages, and a pentode. No earth connection was used.

As regards 5SW, we enclose a copy of a report which may prove of interest, in that the speech was picked up from Huizen (16.88 metres), and not from 5SW, which is useless to us in India: 5SW must come down to 16 metres. Huizen and Bandoeng can be heard at any time they are on the air from midnight to 16 hours G.M.T., but 5SW is impossible until 8 or 9 p.m. G.M.T.

Lahore.

B. J. SILVER

(Punjab Automobile & Radio Company).

TELEVISION ECHOES.

Sir,—I was very interested to read the letters of Prof. Appleton and Mr. Sutherland in the issue of April 30th.

Experiments were carried out some time ago in America by, I believe, Dr. Ives, to observe multiple images due to echo signals. In this case a diamond of black lines on a white ground formed the object.

Referring to Mr. Sutherland's letter, I doubt whether it would be possible to employ a relay with the toothed wheel for synchronising on the Baird transmissions. Mr. Geloso used, I think, a disc with forty-four picture strips and one synchronising strip. If the disc revolves at a speed of 7.5 revolutions per second the relay will also operate at this speed. The synchronising signal in the Baird system, however, consists of a black line at the bottom of the picture formed by a dot at the end of each strip. Assuming that the relay could be arranged to act when a black dot is transmitted it would have to operate $30 \text{ (number of strips)} \times 12\frac{1}{2} \text{ (number of pictures per second)} = 375$ times per second. Even if this were possible synchronisation might easily be upset when dark masses such as hair were transmitted.

G. H. L. THOMAS.

Leytonstone.

READERS' PROBLEMS.

"The Wireless World" Supplies a Free Service of Technical Information.

The Service is subject to the rules of the Department, which are printed below; these must be strictly enforced, in the interest of readers themselves. A selection of queries of general interest is dealt with below, in some cases at greater length than would be possible in a letter.

An Electrical Equivalent.

In dealing with a transformer-coupled H.F. amplifier that is lacking in stability, it is usually recommended that a reduction should be made in the number of primary turns. This procedure is obviously impossible when tuned anode coupling is employed, as there is only a single winding. Is there any means whereby the same effect may be produced without introducing any serious alterations to the circuit?—E. W. H.

In the normal tuned anode circuit, the plate of the H.F. amplifying valve is joined directly to one end of the coil, the other end being connected to the H.T. battery. By moving the plate connection to a tapping point towards the low-potential (H.T.+) end of the coil, an effect electrically similar to that obtained by reducing primary turns is produced.

"Kilo-Mag Four" Detecotr.

Would there be any serious disadvantage in adapting the new "Kilo-Mag Four" receiver for power grid detection in the manner discussed in the issue of May 7th? M. G. R.

The detector-L.F. arrangement of the "Power Pentode Two" receiver could certainly be transferred to the "Kilo-Mag Four," but the tuning of its second interval coupling would be considerably flattened by the load imposed by this method of rectification.

It would be desirable to compensate for selectivity loss in this way by adding a tuned aerial circuit in the manner described in *The Wireless World* of November 13th, 1929.

RULES.

- (1.) A query must be accompanied by a COUPON removed from the advertisement pages of the CURRENT ISSUE.
- (2.) Only one question (which must deal with a single specific point) can be answered. Letters must be concisely worded and headed "Information Department."
- (3.) Queries must be written on one side of the paper and diagrams drawn on a separate sheet. A self-addressed stamped envelope must be enclosed for postal reply.
- (4.) Designs or circuit diagrams for complete receivers or eliminators cannot ordinarily be given; under present-day conditions justice cannot be done to questions of this kind in the course of a letter.
- (5.) Practical wiring plans cannot be supplied or considered.
- (6.) Designs for components such as L.F. chokes, power transformers, complex coil assemblies, etc., cannot be supplied.
- (7.) Queries arising from the construction or operation of receivers must be confined to constructional sets described in "The Wireless World"; to standard manufactured receivers; or to "Kil" sets that have been reviewed.

Coils for S.G. Valves.

I was interested to read in your issue of May 7th that the original "Everyman Four" transformers could be rewound for use with screen-grid valves. Before starting alterations to a spare coil of this type, I should like your advice on one point: I have been told that coils of ultra-high efficiency cannot be used satisfactorily with screened valves, and am therefore wondering whether the altered coils would be capable of giving really good results, or whether the design suggested is merely a compromise to assist readers who wish to use up existing apparatus.—J. M. L.

Up to a point your information is correct; there is a practical limit to the "goodness" of coils that can be used, but only when they are connected to the valve as simple tuned grid and tuned anode inductances. This does not apply when we are dealing with transformers, where there is no practical lower limit to the H.F. resistance of the windings, as there exists a ready means of adjustment by altering the number of primary turns or by varying coupling between primary and secondary in some other way.

As stated in the paragraph to which you refer, these modified transformers are capable of affording amplification and selectivity well above the ordinary standard, and, indeed, the medium-wave coupling (which is the more important) closely resembles that used for the "1930 Everyman Four," to the description of which you are referred for further information.

Striking a Balance.

The neutralising arrangements of my "Record III" do not seem to be working properly. Stability is almost reached when the neutralising condenser is set at maximum, but in any other position violent self-oscillation is produced over the whole of the tuning scale. The coils are made exactly to the published specification, and have been carefully tested for continuity and for insulation resistance between windings. Will you please make a suggestion as to the probable cause of my failure?

B. G. L.

We expect that neutralisation will be achieved if you add half a turn or so to the medium-wave balancing winding. Incidentally, it may be pointed out that the need for a larger winding would suggest that incidental grid-anode capacities are rather higher than usual, and consequently you should look to the efficacy of your screening arrangements.

Reversed Reaction.

My "Wireless World Kit Set" works normally when the long waves are being received, but on the medium broadcast waveband the effect of increasing the capacity of the reaction control condenser is to reduce signal strength. Is it correct to assume that this effect could not be accounted for in any other way than by the fact that the medium-wave reaction coil is wound in the incorrect sense? I should like your opinion on this matter before going to the trouble of dismantling the coil assembly.—A. D. P.

We can think of no other explanation for this effect than that you suggest yourself, and we feel sure that a reversal of the direction of winding of the medium-wave reaction coil—or a reversal of its external connections—will put matters right.

o o o o

The "Power Pentode Two."

In the description of the "Power Pentode Two" it is stated that the optional detector anode milliammeter will, under conditions as specified, normally register a current of about eight milliamps., and that, under the influence of applied signals, this reading will be reduced to about 6.5 milliamps. Will you please tell me how the meter will behave when overloading of the detector is taking place? T. B. C.

If the meter needle is observed to "kick" upwards while signals are being received, it may be taken that the detector is overloaded, and that anode-bend rectification is taking place. The remedy, of course, is to reduce input by operation of the pre-detection volume control.

FOREIGN BROADCAST GUIDE.

LYONS (PTT)

(France).

Geographical Position: 4° 47' E. 45° 41' N.
Approximate air line from London: 460 miles.

Wavelength: 466 m. Frequency: 644 kc.
Power: 5 kW.

Time*: Greenwich Mean Time.

* France adopts Britain's Summer Time.

Standard Daily Transmissions.

13.00 B.S.T. studio concert; 20.30 main evening programme, relay of PTT Paris or outside local broadcast.

Male announcer. Call: *Allo! Allo! Ici le poste de radiodiffusion de Lyon PTT.* Between items: *Ici PTT Lyon or Lyon Etat.* Frequently relays the broadcasts of PTT Paris when the call is that of the Ecole Supérieure des Postes et Télégraphes (vide Eiffel Tower).

Interval Signal: One or two strokes on a bell after items in programme.

Closes down with formula usual to French stations (vide Radio Paris).

COMPARE THESE FIGURES WITH THOSE OF ANY OTHER 2-VOLT POWER VALVE

P 240



The goodness of a valve is determined by the highest amplification factor for the lowest anode impedance. This is expressed as mutual conductance, therefore the higher the mutual conductance the better the valve.

The mutual conductance of the Mazda P.240 is considerably higher than that of any other 2-volt power valve. It will operate a moving coil loud speaker with most satisfactory results.

THESE FIGURES PROVE IT . . .

Amplification Factor	7
Anode A.C. Resistance (ohms)	1,900
Mutual A.C. Conductance (MA/V)	3.7

MAZDA P. 240 PRICE 15/-

The Amazing

MAZDA RADIO VALVES

With Mazda valves in all positions your set will give a performance many times better than before.



THE EDISON SWAN ELECTRIC CO., LTD.,
Radio Division,
1a, Newman Street, Oxford Street, W.1.
Showrooms in all the Principal Towns.

EDISWAN

V 48

RADIO DATA CHARTS

A SERIES OF ABACS

providing most of the essential Data required in Receiver Design.

By R. T. BEATTY, M.A., B.E., D.Sc.

Reprinted from "The Wireless World."

"Radio Data Charts" provide designers of wireless apparatus with a ready and convenient means of solving problems without having recourse to complicated formulæ and mathematics.

By the use of the charts it is possible to tackle all the more familiar problems in radio receiver design; such as, for example, finding the relationship between inductance capacity and frequency, and working out the design of high frequency transformers. All keen amateurs will appreciate this helpful book.

Price 4/6 net. By post 4/10.

(39 CHARTS and more than 50 Diagrams.)

From all leading booksellers or direct from the Publishers.

Published from the Offices of "THE WIRELESS WORLD."

ILIFFE & SONS LTD., Dorset House, Tudor St., London, E.C.4.

DICTIONARY of WIRELESS TECHNICAL TERMS

(1926)

Compiled by S. O. PEARSON, B.Sc., A.M.I.E.E.
and issued in conjunction with
"THE WIRELESS WORLD."

This volume contains definitions of terms and expressions commonly used in wireless telephony and telegraphy and is intended to serve as a guide to all those interested in wireless who come across, from time to time, unfamiliar words in their reading. In such cases the DICTIONARY OF WIRELESS TECHNICAL TERMS proves of very great use and value. It is well illustrated, and cross-referenced to enable the required information to be rapidly obtained.

Price 2/- net. By Post 2/2

From leading booksellers or from the Publishers:

ILIFFE & SONS LTD.,

Dorset House, Tudor St., London, E.C.4.

W.W.48

HELPS YOU TO TAKE BETTER PICTURES!

Owners of
cameras and
ciné-cameras will
find practical
hints and tips
on how to obtain
better results
together with
interesting articles
and an Art Supplement
in each issue of

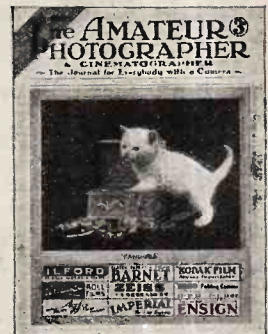

Every
Wednesday
3^D

The AMATEUR
PHOTOGRAPHER
& CINEMATOPHAGER
ILIFFE & SONS LTD., LONDON, E.C.4.

Mention of "The Wireless World," when writing to advertisers, will ensure prompt attention.

B30

MISCELLANEOUS ADVERTISEMENTS.

NOTICES.

THE CHARGE FOR ADVERTISEMENTS in these columns is:

12 words or less, 2/- and 2d. for every additional word.

Each paragraph is charged separately and name and address must be counted.

SERIES DISCOUNTS are allowed to Trade Advertisers as follows on orders for consecutive insertions, provided a contract is placed in advance, and in the absence of fresh instructions the entire "copy" is repeated from the previous issue: 13 consecutive insertions 5%; 26 consecutive, 10%; 52 consecutive, 15%.

ADVERTISEMENTS for these columns are accepted up to **FIRST POST ON THURSDAY MORNING** (previous to date of issue) at the Head Offices of "The Wireless World," Dorset House, Tudor Street, London, E.C.4. or on **WEDNESDAY MORNING** at the Branch Offices, 19, Hertford Street, Coventry; Guildhall Buildings, Navigation Street, Birmingham; 260, Deansgate, Manchester; 101, St. Vincent Street, Glasgow, G.2.

Advertisements that arrive too late for a particular issue will automatically be inserted in the following issue unless accompanied by instructions to the contrary. All advertisements in this section must be strictly prepaid.

The proprietors retain the right to refuse or withdraw advertisements at their discretion.

Postal Orders and Cheques sent in payment for advertisements should be made payable to **ILLIFFE & SONS Ltd.**, and crossed **& Co.** Notes being untraceable if lost in transit should not be sent as remittances.

All letters relating to advertisements should quote the number which is printed at the end of each advertisement, and the date of the issue in which it appeared.

The proprietors are not responsible for clerical or printers' errors, although every care is taken to avoid mistakes.

NUMBERED ADDRESSES.

For the convenience of private advertisers, letters may be addressed to numbers at "The Wireless World" Office. When this is desired, the sum of 6d. to defray the cost of registration and to cover postage on replies must be added to the advertisement charge, which must include the words Box 000, c/o "The Wireless World." Only the number will appear in the advertisement. All replies should be addressed No. 000, c/o "The Wireless World," Dorset House, Tudor Street, London, E.C.4. *Readers who reply to Box No. advertisements are warned against sending remittance through the post except in registered envelopes; in all such cases the use of the Deposit System is recommended, and the envelope should be clearly marked "Deposit Department."*

DEPOSIT SYSTEM.

Readers who hesitate to send money to unknown persons may deal in perfect safety by availing themselves of our Deposit System. If the money be deposited with "The Wireless World," both parties are advised of its receipt.

The time allowed for decision is three days, counting from receipt of goods, after which period, if buyer decides not to retain goods, they must be returned to sender. If a sale is effected, buyer instructs us to remit amount to seller, but if not, seller instructs us to return amount to depositor. Carriage is paid by the buyer, but in the event of no sale, and subject to there being no different arrangement between buyer and seller, each pays carriage one way. The seller takes the risk of loss or damage in transit, for which we take no responsibility. For all transactions up to £10, a deposit fee of 1/- is charged; on transactions over £10 and under £50, the fee is 2/6; over £50, 5/-. All deposit matters are dealt with at Dorset House, Tudor Street, London, E.C.4, and cheques and money orders should be made payable to Illiffe & Sons Limited.

SPECIAL NOTE.—Readers who reply to advertisements and receive no answer to their enquiries are requested to regard the silence as an indication that the goods advertised have already been disposed of. Advertisers often receive so many enquiries that it is quite impossible to reply to each one by post.

"WIRELESS WORLD" INFORMATION COUPON

This Coupon must accompany any Question sent in before **JUNE 4th, 1930**

For Particulars of Free Service, see Rules on page 570.

B&J

ALL WIRELESS WORLD COILS, DIALS & CABINETS
Short Wave Coils, etc.

B&J. Wireless Co.
2, 3, & 4, Athelstane Mews, Stroud Green Rd., N.4.
Archway 1695.

SEND TO-DAY FOR OUR FREE 36-PAGE BOOKLET "SOUND ADVICE."



The Finest High-grade Speaker in the World

PERFECT RECEPTION FOR MUSIC LOVERS

BAKER'S 'Selhurst'

RADIO

Offices: 89, Selhurst Rd., S. Norwood, S.E.26.
Works: 42, Cherry Orchard Rd., E. Croydon.

Super Power Moving Coil Speaker.

BE SAFE!

FOR RADIO PART EXCHANGE

APPLEBY'S

"Where it all began."

CHAPEL ST., MARYLEBONE, LONDON,
Paddington 8828 (3 lines).

Particulars upon request.



BELLING-LEE

The World's Greatest

WANDER PLUG NOW ONLY 3d

Belling-Lee Battery Cord specified in "Radio for the Million."
Price 5/9

BELLING-LEE FOR EVERY RADIO CONNECTION

Advt. of Belling & Lee, Ltd., Queensway Works, Ponders End, Middlesex.

BONA FIDE TRADERS' GUIDE.

Send for our comprehensive Illustrated List. QUICK SERVICE. QUICK SERVICE.

THE QUALITY HOUSE.

PERSEUS MFG. CO., LTD. (Dept. W.W.),
BRANSTONE RD., BURTON-ON-TRENT.

IMPORTANT NOTICE.

Owing to the Whitsun Holidays, the issue of "THE WIRELESS WORLD" for June 11th must be closed for press earlier than usual.

MISCELLANEOUS ADVERTISEMENTS for insertion in that issue can be accepted up to **FIRST POST WEDNESDAY, June 4th.**

RECEIVERS FOR SALE.

SCOTT SESSIONS and Co., Great Britain's Radio Doctors.—Read advertisement under Miscellaneous. [0264]

HIRE a McMichael Portable Set, by day or week, from Alexander Black, Wireless Doctor and Consultant, 55, Ebury St., S.W.1. Sloane 1655. [0328]

STEREOPHONIC Couplers!—Send for new leaflet giving full particulars; the world's finest coupling device, amazing tone, many used in talks.—N. Bonavia-Hunt, 96, Broadhurst Gardens, N.W.6. [9476]

IGRANIC Neutronic Seven Transportable Receiver. 250-1,800 metres. as new; cost £68, accept £18. genuine.—Killbourn, 29, Stert St., Abingdon. [9511]

SUPER-HET, 8 valves, mahogany, valves, folding aerial included; £10/10; perfect condition.—2, Selborne Grove, Bradford. Tel.: 1037. [9573]

LISSEN, Cossor, Mullard, Osram sets, etc., and spare parts supplied; cash or easy payments; Provident and other trading checks accepted.—Acacia Stores, Ltd., 229-231, Upper Tooting Rd., S.W.17. [9564]

AMPLION All-mains Set, cost £50, latest model, as new; £35.—Sandra, The Parade, Meols, Cheshire. [9561]

CELESTION Combined Set and Loud-speaker, 4 2-volt Mullard valves, new 18 A.H. Exide accumulator, Philips 105-volt high-tension supply unit, with Regentone battery charger and Foster transformer, 240/105 volts if required; offers.—Dore, Eastcote Point, Pinner. [9560]

MULLARD Master Three, speaker, complete; £6, cost double.—Thom, 984, Tollcross Rd., Glasgow, E.2. [9559]

BERCLIF D.C.2 All Mains Receiver, 200 to 250 volts D.C.; price £14/10; with valves and royalties, suitable for M.C. speaker; particulars free; trade inquiries specially invited.—Simmonds Bros., Shireland Rd., Smethwick. [8734]

YOUR Old Receiver or Components Taken in Part Exchange for New; write to us before purchasing elsewhere, and obtain expert advice from wireless engineer of 25 years' professional wireless experience; send a list of components or the components themselves, and we will quote you by return post; thousands of satisfied clients.—Scientific Development Co., 57, Guildhall St., Preston. [0226]

GECOPHONE World Wide Four Screened Grid Receiver, with valves, as new; £16.—Box 6197, c/o The Wireless World. [9613]

BRAND New Marconi 5-valve Wireless Set and Marconi Moving Coil Speaker, gets over 30 stations; cost over £37, must sell at £12.

RADIO-GRAMOPHONE, Ferranti push-pull, B.T.H. pick-up, H.M.V. motor, oak cabinet, wonderful set; cost £50, must sell £20.—138, Loughboro' Rd., Brixton, S.W.9. [9608a]

ALL Mains (A.C.) 3-valve Receiver, new; £10.—6, Hauber, Rd., S.W.11. [9608]

HALCYON Portable (34 guineas), little used, spare accumulator; 14 guineas; appointment.—47, Tennyal Rd., Harborne. [9599]

1930 Everyman Four, container, base, and most of parts, wired; £4.—England, Ashburton, Dore, Sheffield. [9597]

FOR Sale, Marconiphone type 81 Straight Right receiving set, in perfect order, new valves, high and low coils, D.C. mains unit, 2 sets accumulators in oak cases; what offers?—Captain Soames, 63, Cadogan Sq., S.W.1. [9586]

BURNEPT Ethodyne Receiver (7-valve super-heterodyne), complete with valves and 2 frames, in mahogany cabinet, £9; ditto, complete with valves and 2 rejector frames, in mahogany cabinet, £11; ditto, with valves and rejector frames, in double door mahogany cabinet, £14; all above guaranteed.—Featherstone, 22, London Rd., Tunbridge Wells. [9595]

OSRAM Music Magnet, only assembled March; £6/5.—Harriman, D.K. 192, Broomhall St., Sheffield. [9591]

RADIO Gramophone, 3v, mahogany cabinet; 19 guineas.—6a, Lyndhurst Rd., Thornton Heath. [9590]

HIGHLY SENSITIVE SUPER-MICROPHONES

New, made on the latest principle, a vast improvement over all other types; will pick up whispered words from a distance of several yards, also strongly amplify and transmit speech and music over a distance, through Loud-speaker or Headphones. Splendid instruments for making Detaphone, DEAF-AID, LOUD-SPEAKING TELEPHONE. Announcements through Loud-speaker, Amplifier for Crystal or Valve Sets. Electric Sound Detector, Experiments.

NO OTHER MICROPHONE OF EQUAL SENSITIVENESS KNOWN; each instrument finely Black enamelled and fitted with a 3-ft. silk connecting cord. Despatched by return post. **8/6**

"BABY ALARM or INVALID CALL"

By suspending Super-Microphone over or near baby's cot, or patient's bed, and connecting through Microphone Transformer to Loud-speaker every sound in bedroom is reproduced with great volume at any distant point.

SPECIAL MICROPHONE TRANSFORMER for connecting Super-Microphone to Radio Headphones, Loud-speaker, Valve Set, or Valve Amplifier **6/-**
SMALL 10 OHMS EARPIECE for use with Super-Microphones as a **HIGHLY EFFICIENT DEAF-AID**, or Detaphone, etc.; thin 5-ft. silk connecting cord fitted. Earpiece finely black enamelled **6/-**

Full Directions for use of Super-Microphone for many purposes and diagrams of connections free.

NEW PUBLIC ADDRESS MICROPHONE

The Ideal Instrument for addressing an Audience through Loud-speaker (via Valve Amplifier or L.F. Stages of Wireless Set), and for relating Speech and Musical Entertainment to any distance. Powerful Loud-speaker Reproduction with perfect Purity.

Hand Type, Highly distance-sensitive, yet guaranteed entirely free from distortion or microphonic noise, absolutely silent background; far superior to ordinary Microphone Transmitters and obsolete Government surplus; for use with Valve Amplifier or Valve Set (through leads of Gramophone Pick-up if desired) at Open-air Meetings, in Cinema, Theatre, or Concert Hall. Operates from 2 Volt Tapping of L.T. Accumulator, through Microphone Transformer. Current consumption one-tenth Ampere. Provided with detachable Sound Collector, handle, hook for suspension, and a 9-ft. silk connecting cord. **16/-**
as illustration.

Microphone Transformer for the above **6/-**
DIAGRAM OF CONNECTIONS FREE.

FREDK. ADOLPH, Actual Maker, 'Phone: MUSEUM 8329
27, Fitzroy Street, London, W.1.

Why not dance to Radio Paris, Toulouse and Hilversum Music?

With the "Supremus" All Electric 2-Valve Receiver it is the simplest matter. So simple that even a child can operate it. You should hear it. Long and short wave stations can be obtained by the mere operation of a switch. This set is equal to any 3-valve **battery** operated receiver. London listeners have been specially catered for and stations can be parted easily. There is a 12 months' guarantee with each set.

Using a "Supremus" All Electric 2-Valve Receiver a Birmingham amateur picked up 18 stations full speaker strength at first attempt.

"SUPREMUS" 2-VALVE ALL ELECTRIC

SUPREMUS SPECIALITIES Ltd., 118, HIGH ST., ERDINGTON, BIRMINGHAM.
Northern Agents: THE CHORLTON METAL CO., 18, Amber Street, Manchester.
London Agent: P. H. SMEDLEY, 50, Richmond Road, Leytonstone, E.11.

Mention of "The Wireless World,"

ACCUMULATOR HIRE.

DON'T Buy Accumulators or Dry Batteries, join our C.A.V. low- and high-tension accumulator hire service, the largest and best in London; better and cheaper reception with no trouble; regular deliveries within 12 miles of Charing Cross; no deposit, payment on each delivery or by quarterly subscription over 10,000 satisfied users; explanatory folder post free; phone or write to-day.—Radio Service (London), Ltd., 105, Torrione Av., N.W.5. 'Phone: North 0623-4-5. [8751]

ACCUMULATORS—BATTERIES.

MAKE Your Accumulators Unspillable.—Jellaxit solidifies the acid, improves efficiency, lessens sulphation risk; price 1/6 per bottle; sufficient for 2x40 amp. cells.—From all dealers, or post free from W. Heasman, 16, Boyne Rd., Lewisham. [9547]

EXIDE 160-volt 5A.H. H.T. Accumulators; 32/6, no offers; Tuesday or Friday evenings.—10, Levensdale Rd., Catford Hill, S.E. [9552]

CHARGERS AND ELIMINATORS.

CHEBROS.—Chebros for all types of transformers and chokes, high grade instruments at a very moderate price; enquiries invited.—Chester Bros., 244, Dalston Lane, London, E.8. [5290]

TANTALUM and Lonium for A.C. Rectifiers; for inexpensive chargers; blue prints for H.T. and L.T., 1/- each; Lonium electrodes, 2-3 and 5-8 amps.—Blackwell's Metallurgical Works, Ltd., Garston, Liverpool. [8298]

PHILIPSON'S Safety High Tension Supply Units for A.C. and D.C. Mains, 200-250 volts 40-60 cycles, also 230 volts 25 cycles.

10/- Down and Small Monthly Payments Secures the Finest H.T. Supply Available.

PHILIPSON'S Safety H.T. Units are Guaranteed for 12 Months Against All Defects.

ALL Models Sold on 7 Days' Approval to Ensure Complete Satisfaction.

PHILIPSON'S Safety H.T. Units are the Cheapest to Install and the Cheapest to Run; £1/17/6 to £6.

WRITE for Our Booklet "Radio Power," which gives illustrations and full particulars.

PHILIPSON'S Safety Loud Speaker Output Filters for All Receivers, power valve, or Pentode; a remarkable output filter at a very low price; 16/6.

PHILIPSON and Co., Ltd., Radio Engineers, Astley Bridge, Bolton. 'Phone: 2038 Bolton. [0318]

ALWAYS Potential Dividers, 20 m.a. type, all values, with 5 variable tappings; 2/6, post free.—Below.

ALWAYS Potential Dividers, 50 m.a. type, wire wound, 5 tapping, 20,000 ohms; 4/8, post free.—Below.

IF Your Dealer Does Not Stock, send direct and ask for complete list of Always resistances.—Abingdon Wireless Supplies, Abingdon, Berks. [9478]

ZAMPA H.T. Eliminator Kit, comprising rectifying unit (incorporating transformer, condensers, Westinghouse H.T.3), necessary condensers, choke, terminals, baseboard, etc., output 120 volts at 20 m.A.; complete, 45/-; 7 days' approval against cash; other Zampa kits and transformers on request.—Mic Wireless Co., Market St., Wellingborough. [9513]

MONOPOLE D.C. H.T. Eliminator, input 220, output 80; 12/6.—Box 6176, c/o The Wireless World. [9572]

H.T., L.T. charger, 50 cycle mains, complete; offers to Whatman, Brockenhurst, Hants. [9562]

SAVAGE'S Specialise in Wireless Power from the Mains, reliable apparatus at reasonable prices.

SAVAGE'S.—Transformer laminations and Bakelite bobbins; intending home constructors should write for list.

SAVAGE'S.—Reliable smoothing condensers, 1,500 volt D.C. test, 1 mid., 2/-; 2 mid., 3/-; 4 mid., 5/3; 500 volt D.C. test, 1 mid., 1/6; 2 mid., 2/3; 4 mid., 3/9.

SAVAGE'S.—Super smoothing and output chokes, many types available; write for list.

SAVAGE'S.—Mains transformer for Westinghouse H.T.4 unit, with additional winding, 4 volts centre tapped 3 amps, 23/-; transformers for other Westinghouse units available.

SAVAGE'S.—Mains equipment for new Foreign Listeners Four, transformer N.F.L.4, 33/-; smoothing choke, C32G, 20/-; output choke C32O, 20/-.

SAVAGE'S Mains Equipment for Power Pentode Two Transformer, P.P.2; 33/-; output choke, L.C.36P.G.; 19/6; smoothing choke, L.C.36G, 18/-.

SAVAGE'S.—Mains transformer B.T.4, 500-0-500 volts, 120 m. amps., 7½ volts 3 amps., 6 volts 3 amps., 4 volts 2 amps., 4 volts 1 amp., 4 volts 1 amp., all centre tapped, specially developed for automatic bias; 57/6.

SAVAGE'S.—Mains transformers and power chokes are carefully and individually constructed from first class materials, with an exceptionally generous margin of safety.

SAVAGE'S, 146, Bishopsgate, London, E.C.2. 'Phone: Bishopsgate 6998. [9165]

RADIELLE Model D.C. 100 (200-250 D.C.), output 200 volt 100 m.a., and 2 variable tappings; cost £9/10; sell £3/5; brand new, sent c.o.d.—Priestley, 74, Aberdeen Rd., Highbury, London, N.5. [9592]

METAL Cabinets



Precisely to specification and sealed with Tubular Brass Gauze, for

ALL "WIRELESS WORLD" SETS

Oak Base and Oak Finish . . . 57/8 complete
Mahogany . . . 63/-
Oak Base and Imitation Leather . . . 63/-
Metal Container and Copper Screens, best woodwork 47/8
New Model-de-Luxe . . . 27 10 0
New Standard Model . . . 24 15 0

Prov. Pat. No. 7024.
As described in "W.W." 14/5/30.

COILS, DRUM DIALS AND ESCUTCHEONS to "W.W." Specification.

1930 Everyman Four 47/6 per set
NEW Kilomay IV . . . 45/-
Record III . . . 45/-
Wave Trap . . . 10/3
5 1/2" Drum Dials with Escutcheons 5/6 each.

RIGBY & WOLFENDEN,

Sheet Metal Workers, Millnrow Road, ROCHDALE. 'Phone 2 948

CABINETS
KABILOK
DISTINCTION

SPECIFIED for the "MULLARD MASTER TWO," THE SPECIAL "KABILOK" COLLAPSIBLE CABINET.

Assembled in 10 minutes.
IN OAK, PRICE 12/- COMPLETE
Write for FREE Catalogue.

W. & T. LOCK LTD.
ST. PETER'S WORKS, BATH
London: 11, Red Lion Square, Holborn, W.C.1.

POWER CHOKES guaranteed twelve months,

substantially built, for smoothing circuits in eliminators dealing with currents too to 300 milliamperes, inductance 30 henries, post free

8/6

Note change of address

REPAIRS

to any make of L.F. Transformer, Loudspeaker or Headphones. All repairs dispatched within 48 HOURS **TWELVE MONTHS' GUARANTEE** with each repair. 4/- Post Free. Terms to Trad.

TRANSFORMER REPAIR CO.

Dept. W., 953, GARRATT LANE, TOOTING, LONDON, S.W.17.

Patent Plug Connectors for Electric Irons.

BAKELITE ADAPTORS with moulded-in contacts, suitable for Eliminators. All Mains Sets, Radio Gramophones, etc.
TURNOCK'S MOULDINGS, 41, High Street, Aston, BIRMINGHAM.

When writing to advertisers, will ensure prompt attention.

Chargers and Eliminators.—Contd.

EKCO 4750 A.C. Eliminator, £3/10; Regentone A.C. portable unit, £2/5; Woodroffe pick-up, £2; all as new.—Box 6183, c/o *The Wireless World*. [9602]
MULLARD H.T. Eliminator, 103 volts, A.C. mains, nearly new; £2/10.—B. V., 10, Parsifal Rd., Hampstead, N.W.6. [9587]
REGENTONE A.C. Unit, 200-250 volts, W.I.B.S.G. 130 volts 20 ma., tappings, S.G. variable, 0-120, fixed, 130-150 volts, as new; £3/7/6.—G. Peppiatt, "The Limes" Studio, Highgate Rd., London, N.W.5. [9584]

CABINETS.

DIGBY'S Cabinets.—Table models in solid oak and mahogany, from 11/6 to 71/-.
DIGBY'S Cabinets, fitted with Radion or Resiston ebonite if required.
DIGBY'S Cabinets.—Pedestal model, with separate battery components; from 56/- to £12.
DIGBY'S Cabinets Made to Customers' Own Designs.
DIGBY'S Cabinets.—Write for new 16-page art catalogue.—F. Digby, 9, The Oval, Hackney Rd., E.2. 'Phone: Bishopsgate 6458. [0128]
KAY'S Cabinets, the greatest range of pedestal cabinets in the kingdom; original creative designs at prices 50% lower than elsewhere; quotations for specials by return; delivery at short notice guaranteed.
RADIOGRAM Cabinets.—A variety of really practical and exclusive models from 60/-; illustrated lists free.
H. KAY, Wireless Cabinet Manufacturer, Mount Pleasant Rd., London, N.17. 'Phone: Walthamstow 1626. 8963
GENUINE Burndept Slightly Used Portable Suitcase Type Cabinets, you know Burndept quality; 12/6 each, carriage paid.—Hughes and Sons, 149, Chepstow Rd., Newport, Mon. [9600]

COILS, TRANSFORMERS, ETC.

TRANSFORMERS and Chokes for Battery Eliminators.—Chester Bros., 244, Dalston Lane, London, E.8. [8652]
1,000 ohms Decoupling Resistances, specified for Power Pentode Two; 1/6 each.—Groves Brothers.
600 ohms Decoupling Resistances, specified for new Kilo Mag Four; 1/6 each, post free.—Groves Brothers.
120 and 1,000 ohms Resistances for new Foreign Listeners Four; 1/6 each, post free.—Groves Brothers.
NEW Kilo-Mag Four Coils, 37/6 set; slotted coil formers, for winding, Kilo-Mag Four 12/6 set, 1930 Everyman Four 8/6 set; Kitset 10/6 set; Ideal home receiver 9/- set, all post free.—Groves Brothers, St. Mary's Place, Shrewsbury. [9361]
BERCLIF Coils, the standard of excellence for all "Wireless World" receivers; latest lists post free; trade supplied, all quantities.—Simmonds Bros., Shireland Rd., Smethwick. [8735]
BAND-PASS Filter H.F. Transformers and Aerial Units, for flat top tuning and no cutting of sidebands, dual wave; 18/6 each.—Groves Brothers, St. Mary's Place, Shrewsbury. [9362]
FERRANTI A.F.6, ratio 1-7, as new, perfect; cost 30/-, accept 22/6.—Write Hanham, 5, Woking Rd., Parkstone, Dorset. [9581]
"WIRELESS World" and Special Coils of every Description.—Send your requirements, metal cabinets from 21/-; aluminium boxes, 6 1/2 in. x 6 1/2 in. x 6 in., 3/9 each; lists free, trade supplied, lowest prices.—Stott, Townhead Radio, Duke St., Rochdale. [9594]

GRAMOPHONES, PICK-UPS, ETC.

PAILLIARD Electric Gramophone Motors, with turntable, 200-250v. A.C., unique principle, no brushes or belt, silent, steady, only 2 main moving parts, automatic stop and switch; £4/10; sent on 7 days' approval against cash.—Watkins and Richardson, 1,148, London Rd., Norbury, S.W.16. [9489]
MAGNIFICENT Triple Spring Motor, from H.M.V. 60 guinea cabinet gramophone, 12in. turntable, automatic brake and speed regulator; 40/-.—Falconer, Birstal, Rose Walk, Purley. [9567]
WOODROFFE, as new, 40/-; Varley, 30/-; B.T.H. without tone-arm, 15/-.—Reply BM/PXJV, London. [9611]
BARGAIN, 21/-.—New type Lissen needle armature pick-up, with arm, as new; B.T.H. pick-up, with arm, 21/-.—Bevins, 4, Londa St., Haggerston, E.8. [9610]
MARCONIPHONE Pick-up, as new, in box; 45/-.—Allsopp, 29, Beulah Hill, S.E.19. [9607]
NEW Electric Gramophone Motor, guaranteed 3 years, works all voltages 12 to 250 volts A.C. and D.C., no belts, silent steady, only 2 moving parts, the world's finest motor; 79/6.—Radiometers, 23, Fawcett Street, Ancoats, Manchester. [9598]



DARIO VALVES

Best Way to All stations!

NEWEST TYPES

SCREENODION

Enormous Range

BIVOLT .15 amp.
FORVOLT .075 amp.

15'6

SUPERBLY SELECTIVE.

The best Screen Grid in the world.

SUPER HF

5'6 BIVOLT .15 amp.
FORVOLT .075 amp.

HYPER POWER 9'6
Bivolt '3 amp.
Forvolt '15 amp.

Super DETECTOR

BIVOLT '15 amp.
FORVOLT '075 amp.

A super sensitive detector for anode-bend or leaky-grid rectification.

6'6

UNIVERSAL RESISTRON 5'6
SUPER POWER 7'6
and the Super Power **PENTODION** 18'6

DARIO L.F. TRANSFORMER

A little marvel. Guaranteed for two years. Completely shrouded. Perfectly designed and perfectly made. 5-1 or 3-1

5'-

Write for Free Folder to:

IMPEX ELECTRICAL LTD.
Dept. C, 538, High Rd., Leytonstone, London, E.11.

LOUD-SPEAKERS.

EPOCH Moving Coil Speakers are Masterpieces, designed and produced by master engineers.
EPOCH Moving Coil Speakers are the Standard by which other Speakers are Compared.
EPOCH Moving Coil Speakers are in Use in Many Editorial Offices.
EPOCH Moving Coil Speakers are in Use in Several Famous Laboratories.
EPOCH Moving Coil Speakers are in Use in Many Broadcasting Stations.
EPOCH Moving Coil Speakers are in Use by Most Prominent Musicians.
EPOCH Moving Coil Speakers Bring Unbounded Joy to Thousands upon Thousands of Homes.
EPOCH Moving Coil Speakers, the only speakers that give clear, uncoloured reproduction.
EPOCH Moving Coil Speakers do Render Speech Perfectly and Music Correctly.
EPOCH Moving Coil Speakers Provide the Perfect Illusion of the Artist's Presence.
EPOCH Moving Coil Speakers Represent the Finest Intrinsic Value Ever Offered.
EPOCH Moving Coil Speakers are Guaranteed for a Year, but last for ever.
EPOCH Moving Coil Speakers Bring the Grand Concert out of the Most Modest Set.
EPOCH—You can hear a hundred moving coil speakers, but Epoch is different.
EPOCH—If you own the best set, only by Epoch can you confirm it.
EPOCH—Away with the tin can and cracked banjo reproduction, and install an Epoch.
EPOCH—Away with the drummy, droniness and huskiness of the average moving coil speakers.
EPOCH—The clearest, sharpest, cleanest reproduction—a marvel of accuracy and beauty.
EPOCH Moving Coil Speaker Models from £2/10 to £30.
EPOCH Moving Coil Speakers.—Models for every requirement and taste.
EPOCH Permanent Magnet Moving Coil Speakers.—Nine models from £3/15.
EPOCH Permanent Magnet Moving Coil Speakers Require no Mains or Batteries.
EPOCH Permanent Magnet Speakers are more Sensitive than most Energised Moving Coil Speakers.
EPOCH Energised Models are the Finest ever put on the Market.
EPOCH Super Cinema Speaker has Created the Biggest Sensation for Many Years.
EPOCH Super Cinema Model is many times as Sensitive as the so-called Supers.
EPOCH Super Cinema Speakers give Enormous Volume from a 1-watt Amplifier.
EPOCH Super Cinema Speakers are used on many 100-watt Amplifiers and never "rattle."
EPOCH Super Cinema Model is Standard on several Talkie Equipments.
EPOCH Super Cinema Model is already in use in over 200 Cinemas.
EPOCH Super Cinema are the only Moving Coil Speakers used in Large Theatres, unaided.
EPOCH Super Cinema Speakers provide alone the Upper as well as the Lower Register.
EPOCH—Other Moving Coil Speakers require the help of exponential horns to provide depth.
EPOCH—A list of many prominent cinemas using the Speakers supplied on request.
EPOCH Speakers are not Made of Tin or Aluminium Stampings, but are sound, solid, engineering jobs.
EPOCH Heartily Invite Comparison, on all counts, with any make, regardless of price or claims.
EPOCH—Don't accept our quality claims without verification, but don't accept any other maker's either.
EPOCH—Order one of 7 days' approval, and test with a switch-over; the only real test.
EPOCH Moving Coil Speakers may be heard in our Demonstration Room Daily.
EPOCH—Our demonstration room is in the heart of London.
EPOCH—Its accessibility has been studied for the convenience of callers.
EPOCH—If you cannot call, write for booklet W.S.3, and approval terms.
EPOCH RADIO MANUFACTURING Co., Ltd. Farringdon Av. (near Ludgate and Holborn Circuses). 'Phone: Central 1971. [8983]

Loud-Speakers.—Contd.

BAKER'S SELHURST RADIO 36-page Booklet, "Sound Advice is Yours for the Asking"; write now for new edition; see displayed advertisement on page 11. [0231]

PERARDUA Moving Coil Reproducers—These superlative instruments may be obtained for 15/- down, balance by 5 equal monthly payments; cash prices, 250-volt D.C., £3/3; 6-volt, £3.—R. Vevers, 4, York Rd., Maidenhead. [9551]

MAGNAVOX, new 10-guinea model, moving coil, horn; 30/-—Lovett, Grosvenor Cottage, Hall Rd., Handsworth, Birmingham. [9569]

CELESTION C12 Loud-speaker, in perfect condition, cost £7/10, owner bought moving coil; price £3.—Tel.: Richmond 3085. Box 6125, c/o *The Wireless World*. [9557]

TRANSMITTERS.

CHEBROS. Chebros. Chebros transformers and chokes of all descriptions, special transformers for transmitting and modulation; chokes a speciality; enquiries invited.—Chester Bros., 244, Dalston Lane, London, E.8. [5240]

600 Volt 8 volt Generator, belt driven, 1/2 h.p. induction motor, stoutly mounted; offers.—Whatman, Brockenhurst, Hants. [9563]

320-METRE Lenses, which are calibrated for doubling to 160-metre band; 4/-.—Smith, Bryn Rodyn, Colwyn Bay. [9585]

VALVES.

AMPLIFIER Valve—If you require power you can not do better than one of these:—

FILAMENT Volts 6, plate volts 400 (maximum), grid bia. 84 volts (approx.), impedance 800 ohms, amplification factor 3.8, mutual conductance 4.35 m.a./volts; price £5/10; see article "The Wireless World," 24th July, 1929, then send to North London Valve Co., Ltd., 22 1/2, Cazenove Rd., Stoke Newington, London, N.16. [9407]

VALVES—P.M.24a, P.M.26, P.M.22, 13/- each; P240 Mazda, S215 Mazda, 12/6 each; S625, 10/-; 2 P625 Osram, 9/- each; all practically new; 6 condensers, 0.002, 5/- lot.—Box 6182, c/o *The Wireless World*. [9601]

COMPONENTS, ETC., FOR SALE.

BELLING-LEE Panel Fittings are designed to give an expert finish to any home-constructed set; catalogue post free.—Belling and Lee, Ltd., Queensway Works, Ponders End, Middlesex. [0018]

WESTON Model 301, milliameters, ammeters, and voltmeters, 21/- each; hot wire ammeters 0-1 amps., 4/-; 0-0.5 amp., 3/-; instrument repairs and alterations; send for list.—The *Victa Electrical Co.*, 47, High St., Battersea, S.W.11. Established 1910. [8626]

COMPONENTS Lent on Hire—Details from Alexander Black, Wireless Doctor, 55, Ebury St., S.W.1. Sloane 1655. [0529]

SUPERDYNE Unit, transforms your obsolete 2- or 3-valve into a powerful portable without extra valves.—Particulars, Ledsham, 297, King St., Hammer-smith. [9569]

1,000 ohms. Decoupling Resistances, specified for Power Pentode Two; see advert. under Coils.—Groves Brothers. [9461]

FERRANTI 3v. 2-stage Push-pull Amplifier, A.F.3C. O.P.3C, complete, perfect, box cabinet; 42/-.—Wilson, 9, Grove Crescent Rd., Stratford, London. [9578]

MULLARD Permacore, 14/6; P.M.14, 12/-—Cooke, Cintra, Ramsgate Rd., Broadstairs. [9568]

EXPERIMENTER'S Surplus—Radcroix mains transformer, 230v. input, 350v., 50 mA. output, for U5, 15/-; Ferranti AF3, 12/6; Pye 32 h.v. choke, 6/-; Simplex A.C. H.T. charger for 200v. mains, charges 150v. up to 200 m.A., 15/-; Wilson bar-amplifier, 12/6; valves, PM5X and 5B, 5/- each; 2M256, 7/6; Marconi U5, 10/-, full emission.—Ratcliff, 449, Brighton Rd., South Croydon. [9570]

1930 Magnavox M.C. Speaker, No. 405, 220v.-50c. £8; R.I. L.F. chokes, 14-28 h., 12/- each; Marconi mains transformer, C., 220-250v., 15/-; AF3, 10/-; LS6A, B12, 10/- each; PM14, 10/6; PM6, PM5, DESB, 4/- each; guaranteed in new condition; must sell; offers.—Essex Electrical Co., 46, St. Stephen's Rd., Bow, London. [9571]

120-VOLT Peto-Radford Accumulator, nearly new, 35/-; Westinghouse rectifier, A3 carton, unopened, 15/6; Ferranti push-pull transformers, AF3C, OP10C, 35/- pair; Panatropie amplifier, 3-valve, D.C. mains, £2; 6-volt 80 amp. Exide accumulator, in crate as new, 27/6; Osram P625, 10/-; Rice-Kellogg moving coil speaker, 6-volt, 75/-; Climax transformer, 12/6.—98, Park Av., Barking. [9579]

FERRANTI Transformer, AF5, 15/-; Exide accumulator, 80-volt, 5,000 milliamps, 20/-; little used; 2v. Mullard pentode, 15/-, unused.—Faulkner, 175 Station St., Burton-on-Trent. [9580]

EPOCH MOVING COIL SPEAKERS

The Greatest Success in Wireless to-day.

While other manufacturers have slowed or closed down completely for the season, Epoch is still working 16 hours per day to cope with the avalanche of orders.

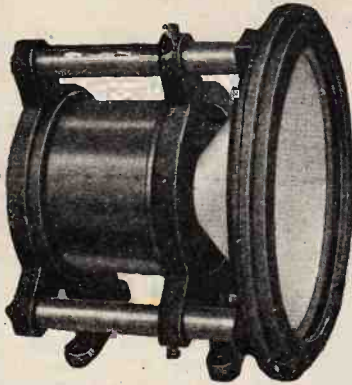

There is a sound reason for this phenomenal success!

Further increase in production now enables deliveries to be made within 7 days of order.

Call for a demonstration or send for Booklet W.S.3.

Epoch Radio Manufacturing Co. Ltd.,
Farringdon Avenue, E.C.4.

72 PAGE CATALOGUE 4d.

Crammed with illustrations and details of all sorts of fascinating and useful gear, at very reasonable prices.

RADIO-ELECTRICAL-SCIENTIFIC INSTRUMENTS-MOTORS-GENERATORS

Just send a stamped envelope for Special Bargain List.

ELECTRADIX RADIOS,

218, Upper Thames Street, E.C.4.
City 0191. Electradix, Cent, London.

PAREX



BAKELITE DRUM DIALS and PLATES for "W.W." Receivers, per set 5/8.

Satisfaction Guaranteed or Money Refunded.

METAL CABINETS and SCREENS for all "W.W." Receivers.

Coils for "New Kilo-Mag 4," "Kit Set," "1930 Everyman 4," etc.

IDEAL HOME RECEIVER Screen, 17/6—Set of 3 Coils, 45/-.

UNIT H.F. STAGE Screening Box with 5-pin v.-holder, 9/6.

E. PAROUSSI,

10, Featherstone Buildings, High Holborn, W.C.1.

Phone: Chancery 700.

Components, Etc., for Sale.—Contd.

SURPLUS—Ferranti AF5C, £1; OPM3C, 15/-; O.P.3C, 10/-; Varley push-pull input, 15/-; double ratio output, 15/-; all as new.—Putnam, Victoria Rd., Rushden, Northants. [9575]

ORGOLA Three Coils, 10/- pair; W.E. transformer, type GP5, 10/-; PM254 valve, 7/6; Croix mains transformer, 230v., TP2, 10/-—43, Valley Rd., Liver-edge, Yorks. [9574]

D.R. NESPER L.T. Charger, 2v. 4v., 17/6; 2-volters: Mazda 240 super power, 8/-; two Triotrons, R.C., one L.F., 3/- each.—Jenkins, 10, Westbourne Grove, Sketty, Swansea. [9558]

FERRANTI 25:1 Output Transformer, 12/6; P625A, 8/-; P.M. 4D, 5/-; Cossor 610 H.F., 5/-; perfect.—48, The Warren, Heston, Middlesex. [9553]

SET Makers, etc.—Components, as new, and valves; low prices; list or call.—Research, 8, Palmerston Rd., East Sheen, S.W.14. [9556]

RADIO HOUSE, HUDDERSFIELD, issues the Reliability Wireless Guide, which will be sent post free upon request by Messrs. J. H. Taylor and Co., 15, Macaulay St., Huddersfield. [7823]

PART Exchange—See our advertisement under Receivers for Sale.—Scientific Development Co., 57, Guildhall St., Preston. [0228]

M-I. Motor Generator, input 220v. A.C., output 350v. D.C., 50 m.a., 5v. D.C. 5 amps., smoothing equipment, H.T. and L.T. automatic cut out, new condition; £15.—Below.

B.T.H. Motor Generator, 200-250v. D.C. input, 750v. D.C. 140 m.a. output, in metal case, working order; £10/10.—Below.

8-VALVE Resistance Coupled Amplifier, in 4ft. teak case, 4 Turner's milliameters on front panel, copper screened, used by well known gramophone company, new condition; £12/10.—Below.

A FEW More 3-valve Push-Pull Amplifiers Left, containing 1 Ferranti A.F.3C transformer, ditto O.P.4C, 2 decoupling resistances, Hydra 2 and 4 M.F.C.s, valve holders, terminals, etc., 32/6; carriage paid.—Below.

B.T.H. R.K. M.C. Speaker, 200v. D.C., £2/5; all the above goods can be seen 5.30 to 7.30 evenings, or by appointment.—Franks, 42, St. George's St., London, E.1. Phone: Royal 8546. [9582]

WEBSON Pot, 230 volt, diaphragm, moving coil, 45/-; Brown's H.I. loud-speaker, £2; 2 pairs Sterling phones, 7/6 each; power Charostak, 7/6; all as new. Wanted, Burndett pick-up, motor, and turntable, Novotona.—Box 6198, c/o *The Wireless World*. [9614]

COLVERN Dual Coil, 8/6; Wearite Titan, 8/6; Lotus Q.A., 8/6; Lewcos Q.A.T., 8/6; Tunewell Dual, 6/-; Watmel dual, 7/-; P.M. 5-guinea speaker, 37/6; Watmel cone and chassis, 13/-; Westinghouse rectifier, H.T.4, with Varley mains transformer, 200-40v., 37/6; Junit multi switch, 3/9; P.M.24, 10/-; P.M.4D.N., 5/- pair; matched Mazda 240, 15/-; A.C./H.I., 8/-; A.C./S.G., 15/-; S4V, 15/-; pair Cossor coils, 6/-; Harlie wave trap, 7/6; Wearite Talsman, 4/-; all as new; Dual electric gramophone motor, with turntable, as reviewed last week's issue, unused, 47/6; new goods as follows, Geophone shrouded transformers, 2-1, 4-1, 8/- each; turntables for portables, aluminium, 2/9; Ediswan R.C.C. units, 2/9; Philips 328 rectifier valves, for L.T., 7/-; foregoing retailers' bankrupt stock.—G. A. Ryall, 182, Kennington Rd., London. [9588]

TWO Double Cone Speakers, complete, in 15in. mahogany and 18in. oak cabinets, £3/5 each; 2-valve pentode set, Cossor, pentode, in mahogany cabinet, £4/5; R.I. pick-up, 25/-, above new; P650, 9/-; P.M.4D., 7/-; any particulars on request.—Hammond, 1, Stratford St., Nuneaton. [9589]

84/- Airchrome Chassis, £3; P.M.6D., 7/-; 2 P.625A., 10/- each.—Box 6185, c/o *The Wireless World*. [9604]

M-L Converter, 12v. input, 400v. 40 mA. output, new, £5/15; L.S.6A. valve, £1.-18, Lothair Rd., N.4. [9609]

AMATEUR'S Surplus—Milliameters, valves, transformers, speakers, condensers, pick-ups, chokes, dual range coils, etc., Mullard L.T. charger, radio gram. cabinets.—26, Watson St., Newington Green, N.16. [9612]

MISCELLANEOUS.

ALEXANDER BLACK,

THE Original Wireless Doctor, will call (London and Home Counties) and cure your set.

CONSULTATIONS by Appointment without Obligation, sets installed, maintained, and brought up to date, gramophone pick-ups, eliminators, and Webson moving coil speakers demonstrated; purity reproduction specialists.

55 Ebury St., Victoria, S.W.1. Sloane 1655. [0277]

Mention of "The Wireless World," when writing to advertisers, will ensure particular attention.

Miscellaneous.—Contd.

EASY Payments.—We supply, by easy payments, components, accessories, and sets, any make; 10% down, balance spread over 11 months.—Send list of requirements to London Radio Supply Co., 11, Oat Lane, London, E.C.2. [0337]

CALIBRATE Your Set With the C.D.E.S. Calibration Chart; 8d., post free.—C.D.E.S., 98, Cherry Orchard Rd., Croydon. [8612]

SCOTT SESSIONS and Co., Great Britain's Radio doctors, officially approved as wireless repairers by Radio Society of Great Britain and Wireless League; send sets of every type repaired, rebuilt, modernised; send set for immediate quotation.

SCOTT SESSIONS and Co.—New sets constructed with your or our components, guaranteed finest workmanship; we specialise in "The Wireless World" circuits, remember, we have satisfied customers throughout the British Isles and in three Continents; if you so desire, we will design and construct high grade apparatus to suit your special circumstances for quality, range and selectivity.—Tel.: Tudor 5326. Muswell Hill, London, N.10. [0262]

ENGINEERS.—Novice or expert; £300, £400, £500 per year or more is within your grasp. In our handbook "Engineering Opportunities," Prof. A. M. Low explains where the good posts abound. This handbook has shown the way to better things to over 20,000 of your fellows. It contains details of A.M.I.Mech.E., A.M.I.E.E., A.M.I.C.E., A.M.I.A.E., A.M.I.Struct.E., Matric., C. and G., G.P.O., etc., Exams., outlines home study courses in all branches of electrical, mechanical, motor and wireless engineering, and shows the unique advantages of our appointments department. Why stay in the Hammer and File Brigade? Send for our free handbook at once, stating branch, post or exam. which interests you.—British Institute of Engineering Technology, 87, Shakespeare House, 29-31, Oxford St., London, W.1. [9280]

DANCING, etc.—Powerful electric gramophone for hire, suitable for indoor or outdoor dancing, concerts, fetes, etc.—Particulars Lambert, 163, Gunnersbury Lane, Acton. Chiswick 1192. [9566]

PATENT AGENTS.

PATENTS and Trade Marks, British and foreign.—Gee and Co. (H. T. P. Gee, Member R.S.G.B. and A.M.I.R.E.), 51-52, Chancery Lane, London, W.C.2. Phone: Holborn 1525. [0001]

KING'S PATENT AGENCY, Ltd., 146a, Queen Victoria St., E.C.4.—Free advice and handbook on patenting inventions and registering trade marks by registered agent with 43 years' experience. [0002]

AGENCIES.

REPRESENTATIVES (part time) and Distributors Wanted Throughout U.K. by Leading Ebonite Manufacturers, generous commission, splendid proposition to live men with connection; state territory.—Trelleborgs Ebonite Works, Ltd., Union Place, Walls St., W.1. [9496]

REPAIRS.

SCOTT SESSIONS and Co., Great Britain's radio doctors; read advertisement under Miscellaneous column. [0263]

REPAIRS Returned Post Free, and to ensure satisfaction send remittance after approval of same.—Leeds Wireless Repair Service.

LOUD-SPEAKERS, headphones, rewound to any resistance and remagnetised. 3/- transformers rewound, 4/-; Blue Spots, Triotrons and 4-pole units, 4/6; work guaranteed.—Leeds Wireless Repair Service, 5, Boston Place, Green Rd., Leeds. [9329]

EXPERT Service by Skilled Engineers, any type of set overhauled or modernised; specialists in portables, all main receivers, and high power amplifiers; estimates free; write or phone your requirements.—Lambert, 163, Gunnersbury Lane, Acton. Chiswick 1192. [9565]

GUARANTEED Repairs by Experts.—Loud-speakers, headphones, cone units, pick-ups, any type, rewound, remagnetised, and adjusted post free 4/-; transformers, from 4/-.—Howell, 91, Morley Hill, Enfield, Middlesex. [9555]

WANTED.

ALL Types of Electrical and Wireless Apparatus Purchased for Cash; large quantities only.—T. W. Thompson and Co., 17, Stratton Ground, S.W.1. [0331]

COLUMBIA Receiving Set 304 for 200 A.C.—Polly, Pierhead, Eastbourne. [9531]

MILLIAMMETERS, 0-250 (about), cone speakers, not moving coil, good gramophone, A.F.6 transformer, in exchange for experimenter's surplus; card for list.—Wynn, Balsall Common, Coventry. [9554]

DIAPHRAGM Type Loud-speaker Units, Amplion A.U.4 preferred; state number and cash terms.—Carter and Co. (Nelson), Ltd., Nelson, Lancs. [9576]

SPECIAL SUMMER OFFER!



Limited number only.

5-VALVE PORTABLE KIT

including attache case

£3.10.0

Valves & Batteries Extra

We GUARANTEE its satisfactory performance.

An efficient, reliable and convenient self-contained receiver for home and outdoor use.

Will bring in British and numerous Foreign stations.

Wavelength range 250-550 and 1000-2000 metres.

SCIENTIFIC SUPPLY STORES,
126, Newington Causeway, London, S.E.1.
Phone: Hop 4177.

HIGH-GRADE FIGURED OAK WIRELESS CABINET

Designed to take Set, Loud Speaker and Batteries.

Height, 3 ft. 1 in.
Width, 1 ft. 10 in.
£2 15 0.

Carriage Paid.

RADIO-GRAMPHONE CABINET.

Height, 3 ft. 7 in.
Width, 1 ft. 10 in.
£5 5 0.

Carriage Paid.

Illustrated Lists Free.

GILBERT, Cabinet Maker, SWINDON.

Estimates Free. Established 1866.

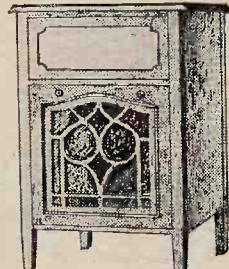

The Brilliant "GRASSMANN" Moving Coil Loudspeaker



6 volt, 100 volt D.C., 240 volt D.C.
£4 - 17 - 6

240 volt A.C. NO HUM model
£8 - 5 - 0

Ask your Dealer to let you hear a Grassmann Moving Coil. You will immediately agree with Mr. J. H. Reyner's remarks in the March issue of Wireless Magazine.

THE FINEST & LIGHTEST MOVING COIL MADE!

The best dealers stock "Peter Grassmann" products, but should you have any difficulty send us your dealer's name and address and we will arrange a demonstration for you, so that you may hear the natural reproduction of Radio—made possible only by the introduction of the Peter Grassmann Moving Coil Loudspeaker!

ROTOR ELECTRIC LIMITED
2-3 UPPER RATHBONE PLACE, LONDON, W.1.

Wanted.—Contd.

WANTED, "Experimental Wireless," February, 1930.—G. E. Stechart Co., 2, Star Yard, Carey St., W.C.2. [9583]

GENERATORS, two 400-1,000 volts, for radio vans, complete with petrol engines preferred.—Radio Ads., 1, Royal Terrace, Barrack Rd., Northampton. [9593]

EXCHANGE.

WE Will Accept Your Surplus Apparatus (making you a high allowance), in part payment for any new apparatus; your enquiry will be dealt with promptly.—Bostock and Stonhill, 1, Westbourne Terrace, S.E.23. [9577]

SITUATIONS VACANT.

A MATEUR Constructors Wanted as Agents in A.C. Districts for Eliminator Kits, etc.—Details from Fel-Ectric Radio, 56, Garden St., Sheffield. [9258]

WIRELESS Operating; fees payable after appointment; amateur Morse classes.—Manager, Wireless School, 21, Manor Gardens, London, N.7. [9378]

WIRELESS Services.—The premier telegraph college in the British Isles (established 34 years) gives a sound training to all students, with assured positions on qualification; fees are not disguised under expensive board-residence schemes but are payable by easy instalments, if desired.—Apply for Prospectus, Dept. "W.W.", The London Telegraph Training College, Ltd., Morse House, Earl's Court, S.W.5. [9268]

SOUND Reproducer Section of the British Thomson-Houston Co., Ltd., requires engineers; applicants must give full particulars of technical training and subsequent experience, especially in connection with talkie equipments.—Apply by letter to Construction Dept., B.T.H. Co., Ltd., Rugby. [9472]

WANTED, youth for inside and outside radio repairs, overhauls and installations; must be competent; S.W. district.—Box 6184, c/o The Wireless World. [9603]

SITUATIONS WANTED.

OPERATOR (21), fully qualified, P.M.G. certificate, thorough knowledge all branches radio, seeks responsible position.—Box 6187, c/o The Wireless World. [9606]

RADIO Engineer, age 24, experienced in design and operation mains radio and power amplifiers, would undertake laboratory or service work, with radio, gramophone or talkie firm.—Box 6186, c/o The Wireless World. [9605]

BOOKS, INSTRUCTION, ETC.

FREE: Inventor's Guide on Patents.—T. A. A., 253, (W), Gray's Inn Rd., London, W.C.1 [6373]

TELEVISION.—The complete authorised book on television (Baird Experimental) transmission and receiving, is now ready; order "Television To-day and To-morrow" (Moseley and Barton Chapple), 7/6 net.—Pitman's, Parker St., Kingsway, W.C.2. [9309]

STEP by Step Wireless.—A complete course of instruction for wireless engineers; send 1/- for first 4 weeks.—Clifford Pressland, A.M.I.E.E., Hampton-on-Thames. [0195]

T.I.G.B. Radio-Engineering Course, cost £9/10, books, papers, complete; sell best offer.—96, Drakefield Rd., Balham. [9586]

ELEX

T.14 PLUGS & SOCKETS.

Standard Socket 1d. each. Plugs 3d. each, 6 colours. Name Plates, 40 kinds, 1d. each. Write for list X101.

J. J. EASTICK & SONS, 118, Bunhill Row, London, E.C.1.



Plug in parts.

A 2d. Stamp brings you Post Free a **POLAR TUNING GRAPH** which enables you to record and identify any station by its wavelength.

Dept. "W."

WINGROVE & ROGERS Ltd.
188-9, Strand, London, W.C.2.



INDEX TO ADVERTISEMENTS.

Adolph, Fredk.	PAGE 12
Appley, E. Hetherington	11
B. & J. Wireless Co.	11
Baker's "Selhurst" Radio	11
Bayliss, William, Ltd.	Cover iii.
Belling & Lee, Ltd.	11
Brownie Wireless Co. (G.B.), Ltd.	
Bullphone, Ltd.	16
Burne-Jones & Co., Ltd. (Magnum)	
Burton, C. F. & H.	Cover i.
Cole, E. K., Ltd.	5
Day, Will, Ltd.	16
Dubilier Condenser Co. (1925), Ltd.	3
Eastick, J. J., & Sons	15
Edison Swan Electric Co., Ltd.	9
Electradix Radios	14
Electrocet Radio Co.	
Epoch Radio Mfg. Co., Ltd.	14
Ever Ready Co. (G.B.), Ltd.	Cover ii.
Forno Co.	
General Electric Co., Ltd.	1
Gilbert, J. C.	15

Goodmans	PAGE
Heayberd, F. C. & Co.	
Hegra	7
Holzman, L.	
Hughes, F. A. & Co., Ltd.	8
Imperial Airways	4
Impex Electrical, Ltd.	13
Jackson Bros.	
Lectro Linx, Ltd.	
Lever, Eric J. (Trix), Ltd.	4
Lock, W. & T., Ltd.	12
London Radio Supply Co.	
Lustrolux, Ltd.	
Lyons, Claude, Ltd.	Cover i.
McMichael, L. Ltd.	
M-L Magneto Synd., Ltd.	6
Mullard Wireless Service Co., Ltd.	Cover iv.
Paroussi, E.	14
Perseus Manf. Co., Ltd.	11
Philips Radio	
Radio Instrument, Ltd.	7
Radiogramophone Development Co.	

Rigby & Woolfenden	PAGE 12
Rothermel Corporation, Ltd. (Centralab)	16
Rotor Electric, Ltd.	15
Scientific Supply Stores	15
Standard Telephones & Electric Co., Ltd.	
Supremus Specialities, Ltd.	12
Telegraph Condenser Co., Ltd.	2
Telsen Electric Co., Ltd.	Cover i.
Thomas, Bertram	5
Transformer Repair Co.	12
Tungsram Electric Works	Cover i.
Turnock's Mouldings	12
Ultra Electric, Ltd.	
Varley (Oliver Pell Control, Ltd.)	3
Watmel Wireless Co., Ltd.	6
Westinghouse Brake & Saxby Signal Co., Ltd.	2
Weston Electrical Instrument Co., Ltd.	6
Wilkins & Wright, Ltd.	
Wingrove & Rogers, Ltd.	15
Yates Sutton, Ltd.	

FOR THE
**LINEN-DIAPHRAGM
SPEAKER**

THE "HOLDFAST"

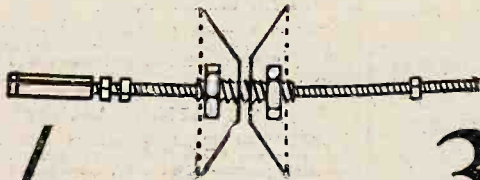

1/- 3^{D.}

BY POST EXTRA

PLEASE STATE THE TYPE OF UNIT THAT THE "HOLDFAST" IS REQUIRED TO FIT.

CATALOGUE—FREE

BY POST 6d.

WILL DAY LTD.

19, LISLE STREET,
LEICESTER SQ., W.C.2.

'PHONE: REGENT 0921-22.

BULLPHONE
A.C. and D.C. ELIMINATORS
For volume and background silence.

D.C. Model 1. Total Output 25 m.a. 120 volts.
Price 27/6

D.C. Model 2. 25 m.a. 120 volts. With two variable
tappings 0-130 volts. One Power-fixed
tapping 120-130 volts. Price 37/6

A.C. Models for all voltages between 110 and 250 volts,
40 to 100 cycles.
Prices from £3 19 0 to £10 10 0

Send for our Free Lists and Circuits—
BULLPHONE LTD. (Dept. W.W.), 38, HOLYWELL LANE,
LONDON, E.C.2.

CONTROL

is
half
the
battle!



Eyes glued to the range-finder—delicate nerves of wire from the conning tower to the gun turrets—it's all a matter of control.

Less dramatic but most important is the delicate control that holds in check the powerful amplifications of your radio valves.

For smooth, efficient performance be sure the volume control on your radio is CENTRALAB.

Write for Free Booklet, "Volume Control, Voltage Control and Their Uses."

Centralab

THE ROTHERMEL CORPORATION LTD.,
24 Maddox Street, London, W.1.

'Phone: MAYFAIR 0578/9.

The
Yachting World
and
Motor Boating Journal

The Leading British Yachting Journal

"THE YACHTING WORLD" deals with yachts and boats of all types and tonnages, whether on the sea or inland waters. Every aspect of yachting and motor boating is covered in an attractive and interesting manner.

Every Friday 6^{D.}

ILIFFE & SONS Ltd., Dorset House, Tudor St., London, E.C.4

W.W. 81

Mention of "The Wireless World," when writing to advertisers, will ensure prompt attention.

BAYLISS

Superior Quality Power Transformers
and Chokes for the Mains from 35/- each
—to Customers' Requirements.

BAYLISS ROTARY CONVERTER



A.C. from D.C.

Load 400 Watts.

ANY Input.
ANY Output.

PRICE

£12 . 10 . 0

For Audio
Amplifiers
and General Purposes.

Also Dynamos,
Motor Generators, etc.
for all purposes.

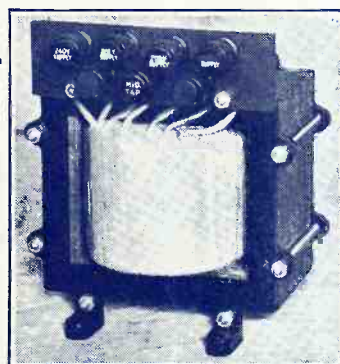

WILLIAM BAYLISS LTD.

Contractors to the Admiralty, War Office, Colonial Governments, etc.

Sheepcote Street

BIRMINGHAM

Telephone :
Mid. 1409.

Telegrams :
"Drawbench, B'ham."

Advertisements for "The Wireless World" are only accepted from firms we believe to be thoroughly reliable.

The 4th valve in a 3 valve A.C. Receiver

D.W.2.

A full wave valve giving a maximum
output of 60 mA. at 250 volts.

Filament Voltage - - - 4.0 volts.

Filament Current - - - 1.0 amp.

PRICE 17/6

D.U.15.

A half wave rectifier, giving a high
voltage output up to 60mA. at 500
volts.

Filament Voltage - - - 7.5 volts.

Filament Current - - - 0.6 amp.

PRICE 15/-

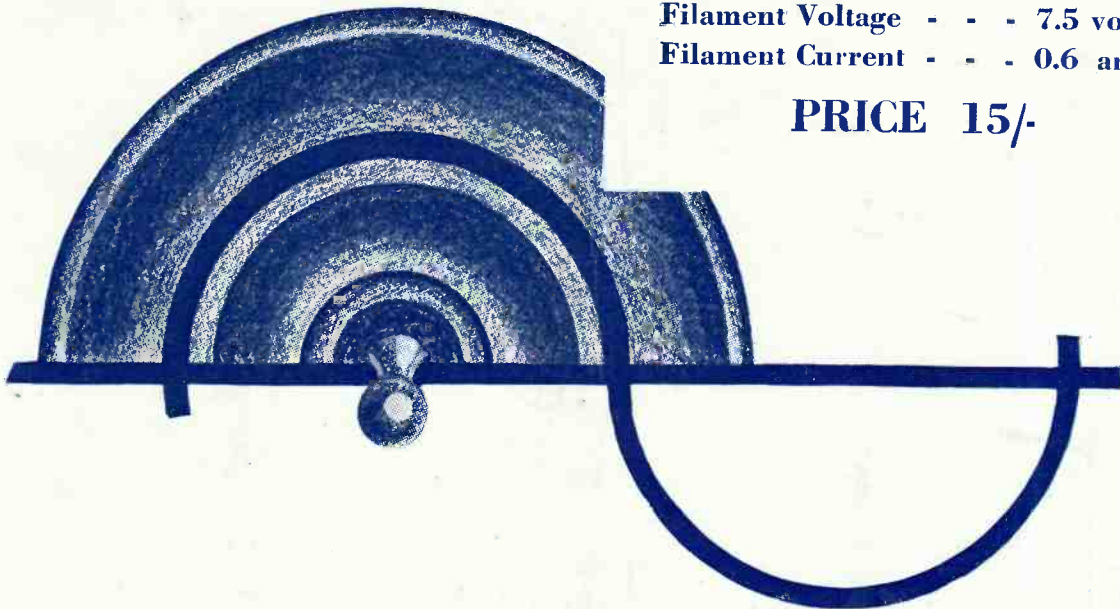

Mullard Master Rectifier Valves for A.C. Sets and H.T. Units

Advt. The Mullard Wireless Service Co. Ltd., Mullard House, Charing Cross Road, London, W.C.2.

*A*ks.*

Printed for the Publishers, ILIFFE & SONS LTD., Dorset House, Tudor Street, London, E.C.4, by The Cornwall Press Ltd., Paris Garden, Stamford Street, London, S.E.1.

Special and Foreign Agents:
 UNITED STATES—The International News Co., 131, Varick Street, New York. FRANCE—W. H. Smith & Son, 248, Rue Rivoli, Paris; Hachette et Cie, Rue Réaumur, Paris.
 BELGIUM—W. H. Smith & Son, 78, Marche aux Herbes, Brussels. INDIA—A. H. Wheeler & Co., Bombay, Allahabad and Calcutta. SOUTH AFRICA—Central News Agency, Ltd.
 AUSTRALIA—Gordon & Gotch, Ltd., Melbourne (Victoria), Sydney (N.S.W.), Brisbane (Queensland), Adelaide (S.A.), Perth (W.A.), and Launceston (Tasmania).
 CANADA—The American News Co., Ltd., Toronto, Winnipeg, Vancouver, Montreal, Ottawa, St. John, Halifax, Hamilton; Gordon & Gotch, Ltd., Toronto; International News Co., Toronto, Montreal, Winnipeg, Vancouver, Victoria. NEW ZEALAND—Gordon & Gotch, Ltd., Wellington; Auckland, Christchurch and Dunedin.